

uvex

2020



protecting people

protecting people – our mission

Innovation is the most important part of our company's DNA

Dear customers,

protecting people is our primary goal. We are driven by the desire to create products and services that afford you the maximum level of safety in the workplace. Each and every employee at the uvex safety group works tirelessly – day in, day out – to meet and even exceed your expectations of us and our products.

Innovation is a key factor to achieving this goal in all areas of our business.

We develop products that set new benchmarks in functionality and often go beyond the requirements of the relevant safety standard. We carry out extensive fundamental research across our range of products, which enables us to create the basis for new technologies, manufacturing processes and materials.

As a manufacturer, we can influence the entire value creation chain and we are constantly optimising our production processes. This makes it possible for us to develop and implement innovative sustainability concepts in all areas of our company.

Another key focus of our innovation strategy is digitalising our company and our services. In addition to expanding our digital business processes and developing our online expertise, we are focusing on designing entirely new product concepts in wearable technology. Through intelligent product and service solutions, we provide comprehensive support that can be individually tailored to optimise the safety of your employees.

We make every effort to ensure that the uvex safety group is – and will always be – a competent and trustworthy partner when it comes to the safety of your employees. It is our pleasure to assist you with the important task of protecting people.

The Board of Management,
UVEX SAFETY GROUP GmbH & Co.KG

Stefan Brück (CEO)
Stefan Wehner
Martin Leusmann



Martin Leusmann

Stefan Brück (CEO)

Stefan Wehner

uvex is the innovative

brand system provider

with international manufacturing expertise. We also have a cross-national highly qualified network of strategic partners – including both sourcing as well as sales – that allows us to meet wide-ranging market and customer requirements, offering our entire product and service portfolio.

Innovation

Always including customer requirements and investing in innovative production and process technologies, we develop, manufacture and distribute industrial and non-industrial safety products that fulfil the highest standards in terms of quality, function and innovation. With our comprehensive service concept, we are pursuing the goals of generating measurable added value for customers around the world. We strive to be the leaders in innovation in our field.

Brand

The uvex brand is our future. It is our primary goal that our customers, suppliers and employees join the uvex brand value experience and generate their own success through the strength of our brand.

Digital transformation

supports our existing core competences, creates additional customer value, facilitates the development of new business models (second speed, separate, independent business units) and contributes to securing our existing and future success.

Quality

As manufacturers, we place extremely high quality demands on our products and services. For us, “made in uvex” is a promise of quality we make to our customers, which they can always count on. Our aim is to effectively balance economical, ecological and social commitment. In order to achieve this, we have set demanding standards for our manufacturing sites and products, which also apply to all partners in our network.

Protecting people

People are at the heart of what we do. Protecting and supporting people in their professional and working environment is our company’s goal. We offer our employees opportunities for professional and career development in an international and increasingly digital group of companies. We support the cultural change in the context of digital transformation.

The winner’s podium

is our ultimate target.



protecting people – our mission and responsibility



“Made in uvex”

The sustainability goals of uvex cover the topics of ecology, economy, working conditions and human rights, employees and society, as well as products. A particular focus area is the expansion and modernisation of production facilities owned by uvex. When customers choose an uvex product, they are choosing the “Made in uvex” principle.

“Made in uvex” represents the company’s focus on the production facilities it owns and the many years of fruitful collaboration it has enjoyed with strategic partners, many of whom are located in Germany and across Europe. As a result, we are either responsible for the entire value creation chain or we can have a considerable influence over it – from product conception and development through production and finally to sales.

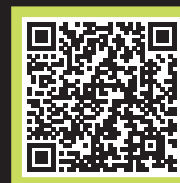

Watch our film now:
**“protecting people
– our mission,
responsibility and
commitment”**

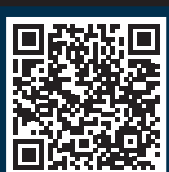

For more information,
please refer to the uvex group’s sustainability report, which has been prepared in accordance
with GRI standards: uvex-group.com/en/responsibility



For over 90 years, we have been producing and distributing high-quality products to protect people in sports, leisure and at work.

Any company wanting to protect people must accept the responsibility that comes with it. It is exactly this mission that instils our commitment to work sustainably and with social responsibility.



Michael Winter, Managing Partner of the uvex group



uvex is committed to CO₂-neutral growth

One of the company's most ambitious targets relates to CO₂ emissions – it is aiming to achieve CO₂-neutral growth over the next few years. The fact that the uvex safety group has already been able to reduce its CO₂ emissions by almost a quarter in the last three years only serves to show that achieving this objective is not just a vision for the future. In some plants, emissions have been reduced significantly further: uvex safety gloves in Lüneburg, Germany, has reduced its CO₂ emissions by 63% since 2016. At the plant in Fürth, Germany, emissions from the production of safety spectacles have been reduced by 40% over the same time period.

uvex Arbeitsschutz, Fürth (Germany)

- construction of a new recycling centre in preparation for the introduction of DIN EN ISO 14001
- installation of a CO₂-reducing lighting system
- installation of innovative and resource-efficient flood cells for coating spectacle lenses
- certification of the energy management system in accordance with DIN EN ISO 50001

uvex safety gloves, Lüneburg (Germany)

- certification of the environmental management system in accordance with DIN EN ISO 140001
- waste management (target of 98% separate collection rate)
- conversion of the shock dryer to gas operation
- certification of the energy management system in accordance with DIN EN ISO 50001

uvex safety Cagi, Ceva (Italy)

- certification of the environmental management system in accordance with DIN EN ISO 140001
- PUR Waste Offensive – project to promote recycling and cut polyurethane waste (recycling target of 35%)

uvex profisystem construction

There is a range of challenges which must be faced in the construction industry, with tasks ranging from preparatory site works and civil engineering to building installation and interior fitting. To achieve optimal results, everyone involved must work in flawless synergy with each other – as must all items of personal protective equipment.



uvex has developed and selected over 150 innovative PPE products for the construction industry, all of which are designed to meet the specific needs of the sector. With 12 product categories, the uvex profi system construction provides the perfect solutions for all areas of application, offering the wearer maximum safety, functionality and wearer comfort.



uvex occupational safety shop for professionals

Discover the complete range of PPE and numerous other products that have been specially designed for the construction industry in the uvex occupational safety shop for business customers:

uvex-safety-shop.com



Professional protection for construction professionals

Extreme noise? Dangerous sparks? Hazardous residual contamination? uvex has the right solution for any application – providing professional protection from head to toe. The safety experts at uvex understand the needs of the construction industry and can provide clear advice to help our customers select the right PPE.



All products accompanied by this symbol are ideal for use in the construction industry.

Outstanding. In innovation and design.

The uvex brand has an outstanding reputation worldwide and has received countless national and international prizes for first-class performance.



Deutsche Standards named uvex a brand of the century, with its innovative safety eyewear representing an entire category of products in 2016.

uvex pheos cx2 safety spectacles won the German Innovation Award in 2018 – this prestigious prize focuses on the people whose future will be positively influenced by the award-winning products.

As one of the most innovative SMEs in Germany, uvex has also been awarded the TOP 100 quality seal on a number of occasions.

Prestigious design awards – including the iF product design award, the red dot design award and the German Design Award – confirm that uvex products meet the highest demands for functionality while still looking good.



Winner 2019: uvex 1 sport
uvex suxceed collection

Nominee 2019: uvex x-fit pro
uvex x-fit

Winner 2018: uvex pheos cx2
uvex sportsline

Winner 2017: uvex professional
metal processing system

Special 2016: uvex 2 VIBRAM
(6502, 6503)



Best product 2018:
uvex x-fit pro

Best product 2017:
uvex 2

Best workwear brand 2017:
uvex workwear
uvex suXXeed



2018
Quality, design and functionality:
uvex x-fit pro

2017
Quality, design, functionality and ergonomics:
uvex suXXeed

2016/2017
Innovation, quality, design, functionality and ergonomics:
uvex 2



Winner 2018:
uvex pheos cx2 — presented with the
German Innovation Award 2018



Winner 2018: uvex 1 sport
Winner 2016: uvex pheos cx2



Winner 2018: uvex x-fit pro
uvex x-fit
uvex 1 sport
Gold 2016: uvex 2 VIBRAM
(6502, 6503)



Winner 2018: uvex perfeXXion
Winner 2017: uvex pheos cx2
Gold 2016: uvex pheos
helmet system

uvex



uvex safety + uvex sports. One brand. One mission.



uvex products protect people at work, in sport and for leisure. As a partner of international top-level sport, uvex equips over 1000 professional athletes worldwide, e.g. with ski goggles, equestrian riding helmets and cycling helmets.

The transfer of knowledge between uvex safety and uvex sports makes our products even safer, more functional and more comfortable – both product divisions benefit mutually from the collaboration.

This is evident in our supravision coating technology, for example, which is used equally by both uvex safety and uvex sports. This unique coating ensures maximum anti-fogging properties on sports goggles and safety spectacles, enabling the wearer to put in their very best performance at work or at play.



Safety Eyewear

Focus on innovation and quality

uvex eye protection centre of expertise

Whether you need safety glasses, goggles, prescription spectacles or laser protection eyewear: In Fürth, Bavaria, uvex develops and produces innovative safety eyewear that meets the highest quality standards. erfüllen.

The uvex plant is certified in accordance with ISO 9001:2015 and ISO 50001:2011, and uses state-of-the-art technology together with close collaboration with strategic partners to develop pioneering technologies.

Because “standard” is not enough

All uvex industrial safety eyewear undergoes stringent testing in our own test centre. As well as satisfying national and international safety standards, every uvex product must fulfil the exacting uvex standards that measure functionality, ergonomics, durability and wearer comfort.

Innovative coating technologies are one of uvex’s core competencies, resulting in first-class, highly practical industrial safety eyewear that are perfectly equipped for their intended area of use.



New: uvex i-5 and uvex megasonic

Examples of such innovation include the new uvex i-5 and uvex megasonic, which were presented for the first time at the A+A 2019 trade fair. You can find more information about our products on pages 22/23 and 48/49.

Only when a product fulfils all the requirements
of the applicable standards
does it earn the uvex name.





Perfect vision for maximum safety

uvex coating expertise



The quality of the lens coating: an absolutely crucial element of safety eyewear

Looking through lenses that are fogged up, scratched or dirty significantly increases the risk of accidents during the work day. uvex has been synonymous with pioneering coating technologies for decades: In our centre of expertise in Fürth, we develop and produce innovative lenses and coatings for a multitude of applications.

Two sides of the lens – two sets of requirements

The unique manufacturing process makes the difference: Unlike conventional processes, the unique uvex process applies different coatings to either side of the lens.

Knowing and exceeding the standard

Standard safety eyewear combines anti-fog and scratch-resistance properties on both sides of the lens – at the expense of optimum performance. Scratch resistance is limited and regular cleaning of the safety eyewear completely removes the anti-fog performance over time, rendering the eyewear ineffective and unusable.

Perfect performance at all times

The performance and durability of uvex eyewear coatings, by contrast, last for the life of the product and take into consideration the varying workplace environments, resulting in a range of coatings that enhances the wearer experience (see following pages).

For example, at uvex, an unbeatably hard and easy-to-clean, scratch-resistant coating can be applied to the outside of the lens, which is prone to getting scratched and becoming dirty. The coating for the inside of the lens, meanwhile, has a long-lasting anti-fog effect, which remains permanently on the lens – meaning it stays put for the life of the product with no drop in performance, even after repeated cleaning.

The result is safety eyewear that is functional, durable and comfortable – for all-day clear vision and maximum safety.

dry 0% RH



uvex supravision excellence

- uvex has a unique process of applying different coatings to each side of the lens, allowing them to perform at maximum efficiency
- the outside of the lens, which is prone to dirt and abrasion, has an extremely scratch- and chemical-resistant coating
- highly effective anti-fog coating on the inside of the lens where it is needed most
- anti-fog properties are permanent and won't wash off, even after repeated cleaning
- areas of application: suitable for a wide range of workplace applications

cold -20°C



uvex supravision plus

- permanent anti-fog and scratch-resistant coating applied to both sides of the lens
- anti-fog properties are permanent and won't wash off, even after repeated cleaning
- areas of application: environments with frequent temperature and humidity fluctuations

Find your perfect coating

1. Select the temperature which best represents your working environment on the horizontal temperature axis.
2. Define the air humidity of the surroundings in percentage terms and find the figure on the diagonal axis.
3. Determine the degree of dirt on the vertical axis.
4. Join these three points to form a triangle.

The part of the triangle with the largest area will show you the appropriate coating for your defined area of use.

Coating technology

dirty

uvex supravision sapphire

- both sides are exceptionally scratch- and chemical-resistant
- uvex Easy-to-Clean effect makes lenses less susceptible to dirt
- areas of application: rugged, dusty and/or dirty environments

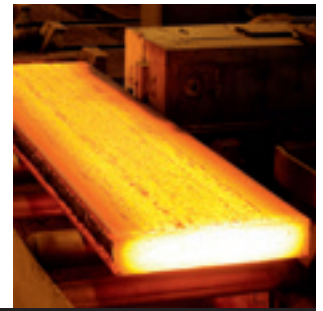
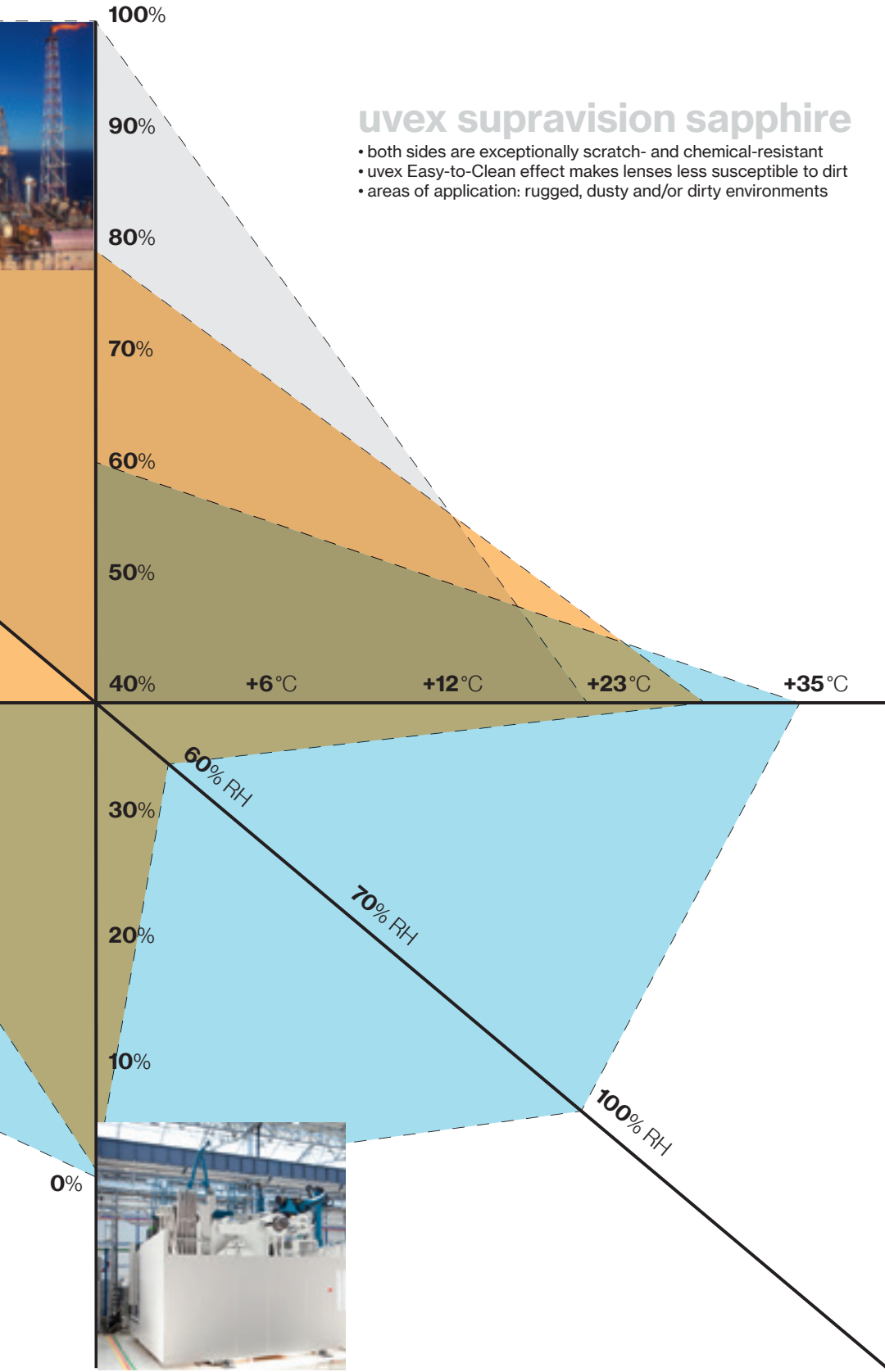

hot +35°C

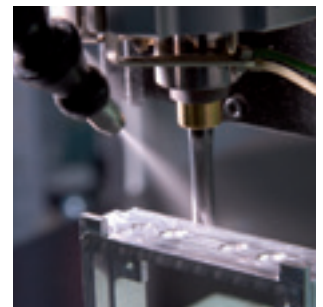

clean

wet 100% RH

Special coatings



uvex supravision extreme

The lenses have a scratch-resistant coating on the outside and a highly effectively anti-fog coating on the inside. The inside of the lenses will not fog up as the coating never reaches the point of saturation. The anti-fog properties are permanent and won't wash off, even after repeated cleaning. Suitable for workplaces with prolonged exposure to high levels of condensation and dirt.



uvex supravision ETC (extreme temperature conditions)

Coated lenses will not fog up, as the coating never reaches the point of saturation. The anti-fog properties are permanent and won't wash off, even after repeated cleaning. Suitable for workplaces that are subjected to frequent temperature and humidity fluctuations.



uvex supravision variomatic

Lenses contain self-tinting filters that react when exposed to UV radiation. Lenses automatically darken within 10 seconds and lighten within 30 seconds when UV light is reduced. Featuring uvex's proven supravision excellence technology (highly effective anti-fog coating on the inside of the lens and extremely scratch-resistant coating on the outside). Suitable for workplaces where you frequently move between indoor and outdoor environments, from light to dark.



uvex supravision clean

Coated lenses are autoclavable and resistant to chemicals. Anti-fog on the inside, extremely scratch-resistant on the outside. The anti-fog properties last for 15 to 20 autoclave cycles. The coating ensures complete fog protection and maximum vision.



uvex infradur

Coated lenses are scratch-resistant on both sides and minimise damage from welding sparks.

uvex infradur plus

Coated lenses are anti-fog on the inside, extremely scratch-resistant on the outside and minimise damage from welding sparks.

Labelling and norms

Marking on frame

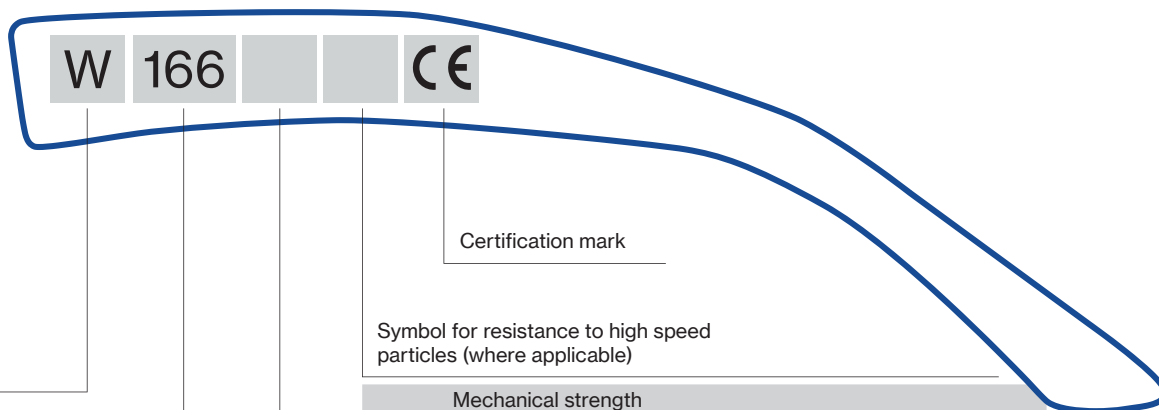

Symbol for resistance to high speed particles (where applicable)

| Mechanical strength | |
|---------------------|---|
| none | without mechanical strength (filters only) |
| S | increased strength (filters only) |
| F | low energy impact (45m/s) |
| B | medium energy impact (120m/s) |
| A | high energy impact (190m/s) |
| T | tested at extreme temperatures (-5°C and +55°C) |

Field(s) of use (where applicable)

| Designation | Description of application areas |
|-------------|---|
| none | General use Non specific mechanical risks, risks due to UV and/or visible IR light |
| 3 | Liquids Liquids (droplets and splashes) |
| 4 | Coarse dust particles Dust with > 5µm grain size |
| 5 | Gas and fine dust particles Gas, vapour, mist, smoke, and dust with < 5µm grain size |
| 8 | Short circuit electric arc Electric arc due to short circuit in electrical equipment |

Marking on lens

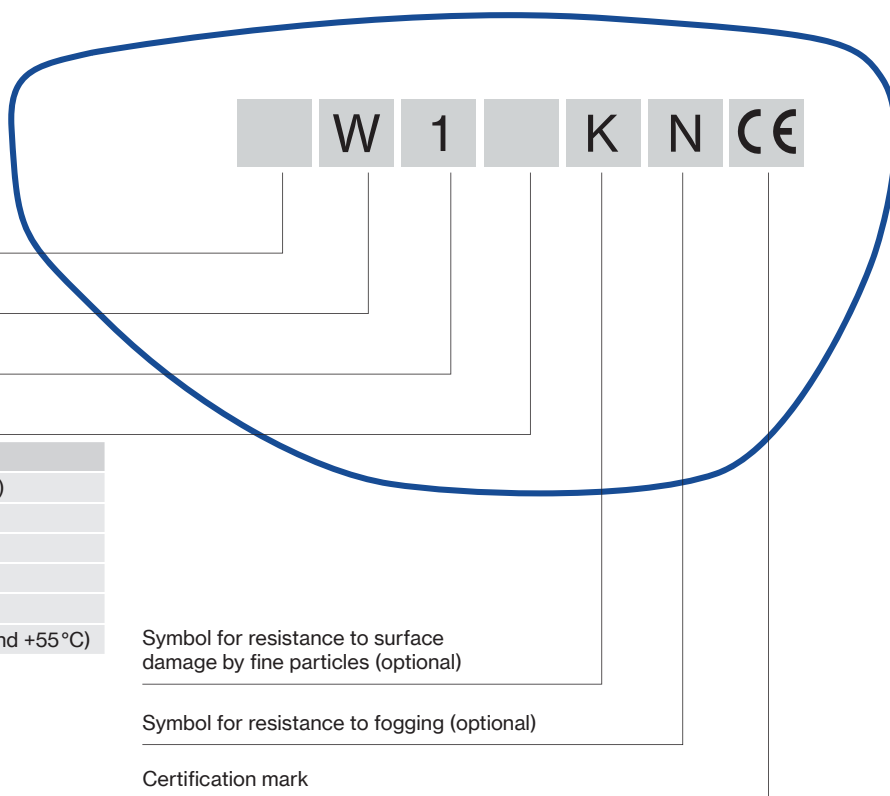

Symbol for mechanical strength

| Mechanical strength | |
|---------------------|---|
| none | without mechanical strength (filters only) |
| S | increased strength (filters only) |
| F | low energy impact (45m/s) |
| B | medium energy impact (120m/s) |
| A | high energy impact (190m/s) |
| T | tested at extreme temperatures (-5°C and +55°C) |

Lens tinting

A lens solution for every light environment



CLEAR

Protection: UV400
 UV/markings: 2(C)-1.2
 Transmission: approx. 91%
 Standards: EN 166, EN 170

Anti-glare mechanical hazard protection



AMBER

Protection: UV400
 UV/markings: 2(C)-1.2
 Transmission: approx. 88%
 Standards: EN 166, EN 170

Anti-glare mechanical hazard protection with enhanced contrast effect



CBR 65

Protection: UV400
 Marking: 5-1.4
 Transmission: 65%
 Standards: EN 166, EN 172

Protection offering relaxing, focused vision

- uvex sportstyle (p. 29)
- uvex pheos cx2 (p. 30)
- uvex super f OTG (p. 64)
- uvex pheos cx2 sonic (p. 50)



AR (anti-reflective)

Protection: UV400
 UV/markings: 2(C)-1.2
 Transmission: approx. 96.5%
 Standards: EN 166, EN 170

Optimum anti-reflective protection with high degree of light transmission

- uvex sportstyle (p. 29)
- uvex i-3, uvex i-3 s (p. 34, 35)

tint with glare protection not necessary ←



74–100% transmission



58–80% transmission

Lens tinting



BROWN

Protection: UV400
 Marking: 5-2.5
 Transmission: 20%
 Standards: EN 166, EN 172

Protection against **natural glare** with **signal colour recognition** and **increased contrast effect**

uvex i-vo (p. 59), uvex skyper (p. 41), uvex ultrasonic (p. 53)



POLAVISION

Protection: UV400
 Marking: 5-3.1
 Transmission: 14%
 Standards: EN 166, EN 172

Reduction of irritating surface reflection by **filtering scattered light**

uvex polavision (p. 43)

tint with contrast adjustment recommended



SILVER MIRROR 53%

Protection: UV400
 Marking: 5-1.7
 Transmission: 53%
 Standards: EN 166, EN 172

Protection in **changing light conditions**

uvex pheos/uvex pheos s (p. 31, 32)
 uvex i-works (p. 36)



SILVER MIRROR 12%

Protection: UV400
 Marking: 5-3.1
 Transmission: 12%
 Standards: EN 166, EN 172

Protection from both highly **artificial light** and **natural glare conditions**

uvex i-3 (p. 34)
 uvex pheos cx2 (p. 30)
 uvex sportstyle (p. 29)

tint with contrast adjustment recommended



GREY 23%

Protection: UV400
 Marking: 5-2.5
 Transmission: 23%
 Standards: EN 166, EN 172

Protection against **natural glare** with **signal colour recognition**



GREY 14%

Protection: UV400
 Marking: 5-3.1
 Transmission: 14%
 Standards: EN 166, EN 172

Protection against **natural glare** with **signal colour recognition**

uvex astrospec 2.0 (p. 37)
 uvex u-sonic (p. 51)

tint with contrast adjustment not necessary

tint with glare protection recommended



43-58%
 transmission



18-29%
 transmission

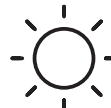

8-18%
 transmission

uvex UV400

100% UV protection. 100% safety. 100% uvex.

The EN166/170 standard requires safety eyewear to provide UV protection up to 380 nm. The latest scientific findings show that this is not enough. The WHO recommends UV protection up to 400 nm.



“The reasons why the WHO recommends UV400 protection are clear. The outer tissues of the eye, cornea and lens fully absorb UV light. While UVB light primarily damages the genetic material, UVA rays penetrate deeper, cause thermal damage and magnify the effects of UVB light.”

Univ.-Prof. Dr. rer. nat. Olaf Strauß



uvex UV400 – included in all uvex safety eyewear

Whether you choose clear or tinted lenses, all uvex safety spectacles are equipped with uvex UV400 effective UV protection as standard – as well as pleasant wearer comfort, a sporty design and top-quality lens coatings.

Even without sun, UV rays can still put strain on the eye

When working outdoors, your eyes are regularly exposed to harmful UV radiation – even when it is cloudy. The result: using insufficient protection risks may cause dangerous long-term damage such as corneal injury, cataracts and blindness.

100% protection against dangerous UVA and UVB radiation

For the eye and surrounding skin

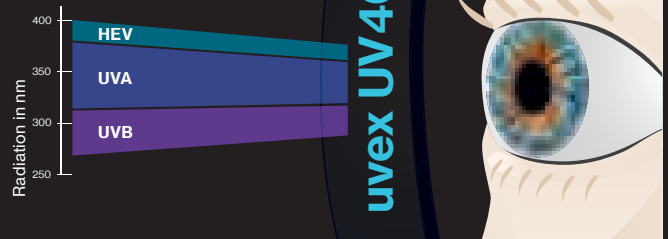

uvex UV400 offers complete protection against UVA and UVB radiation as well as high-energy visible light (HEV) up to a wavelength 400 nm.

uvex UV400 not only filters 100% of UVA rays (20% still passes through 380 nm lenses), it also completely minimises temperature-induced cell changes – a factor which increases tenfold in the percentage of total cell damage in the range from 380 to 400 nm. In addition, the dangerous, damaging blue light content (HEV), which is also harmful to the retina, is reduced by 15%.

uvex safety eyewear,
100% safety.





uvex CBR65

Fatigue-free, comfortable vision

Preventive protection against blue light

The properties of uvex CBR65 lens technology are significantly different to those of uvex UV400.

uvex CBR65 blocks 100% of UV rays and filters high-energy visible light (HEV) – which causes particular strain on the retina in the range from 380 nm to 450 nm – by up to 50%. Above the 450 nm range, only 60–70% of light can reach the retina.



Contrast

Contrast enhancement

Better contrast for clearer vision, helping to reduce strain on the eyes – even in diffused light.

Bluelight reduction

Blue light reduction

In workplaces with extremely harsh lighting conditions, blue light is reduced by up to 50%.

Relaxed vision

Relaxed vision

Ideal for high-concentration work; the eyes get less tired even when working for longer periods.

65% transmission

Slight tint

Provides protection against glare even in extremely bright artificial light or natural light.

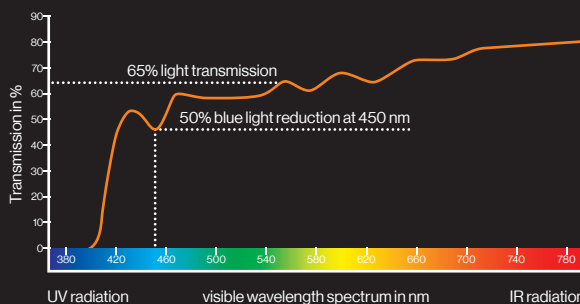

Strain on the eye caused by blue light has increased enormously as a result of intensive use of electronic devices (PCs, smartphones, tablets, LED TVs, etc.) and the switch from incandescent light bulbs to LEDs. The short-term effects of this include eye strain, headaches or poor concentration, while in the long term there is an increased risk of age-related macular degeneration.

uvex CBR65 reliably protects the eye against health risks without disrupting the body's internal clock.

For more information, visit uvex-safety.com/en/product-group/uvex-cbr65/



9193064



9198064



9198064



9309064

| Art. no. | uvex sportstyle CBR65 | uvex pheos cx2 CBR65 | uvex super f OTG CBR65 | uvex pheos cx2 sonic CBR65 |
|--------------------------|--------------------------|-----------------------------|-----------------------------|----------------------------|
| 9193064 | 9193064 | 9198064 | 9169164 | 9309064 |
| Version | uvex supravision extreme | uvex supravision excellence | uvex supravision excellence | uvex supravision extreme |
| Standard | sun protection | sun protection | sun protection | sun protection |
| EN 166, EN 172 | EN 166, EN 172 | EN 166, EN 172 | EN 166, EN 172 | EN 166, EN 172 |
| Frame | white, black | white, black | black, white | white, black |
| W 166 FT CE | W 166 FT CE | W 166 FT CE | W 166 F CE | W 166 34 BT CE |
| Lens | PC CBR65 | PC CBR65 | PC CBR65 | PC CBR65 |
| UV400 | UV400 | UV400 | UV400 | UV400 |
| 5-1,4 W1 FTKN CE | 5-1,4 W1 FTKN CE | 5-1,4 W1 FTKN CE | 5-1,4 W1 FTKN CE | 5-1,4 W1 BTKN CE |
| Weight | 23 g | 28 g | 39 g | 34 g |
| Order quantity multiples | 5 PC | 5 PC | 5 PC | 5 PC |

uvex

uvex i-5

detailed – modern – trusted

Reliable protection thanks to the innovative and modern design: with its x-tended eyeshield and sideshield, the uvex i-5 can be relied on to protect the eyes in any situation. Sophisticated features ensure superior wearer comfort even during long periods of use.



Three-stage inclination
allows easy adjustment
to any facial shape

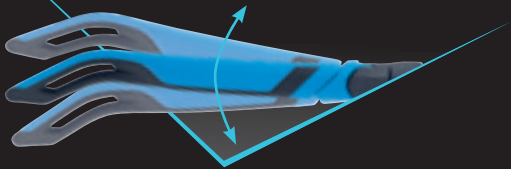

x-tended sideshield
provides optimum protection
around the sides of the eyes



x-tended eyeshield
provides greater protection
against particles, dust and dirt

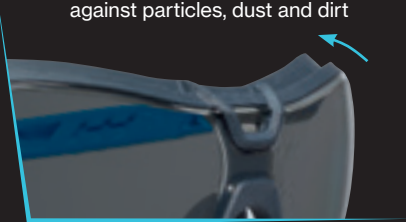

x-twist technology
for flexible and comfortable
adjustment to any head shape

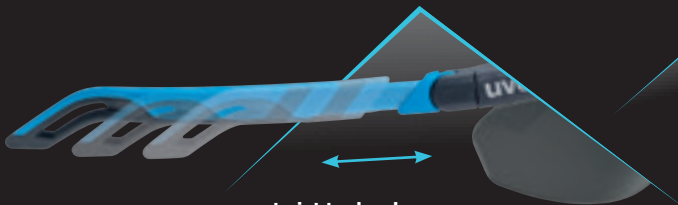

uvex supravision
coating technology



**soft and flexible
nose pad**
for pressure-free wearer
comfort and a non-slip fit

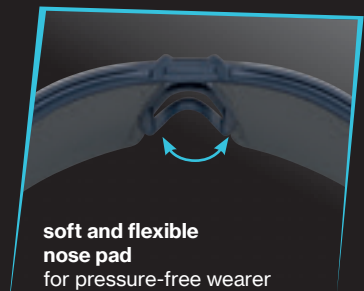

MADE IN GERMANY 

Safety Spectacles

uvex i-5



9183265



9183281



Further information can be found at uvex-safety.com/en/i5 (or scan the QR code).

uvex i-5

- soft, flexible nose pad for maximum comfort and a non-slip fit
- x-tended eyeshield provides additional protection from flying particles, dust and dirt
- x-tended sideshield for increased side protection
- 3-position side arm inclination adapts easily to any facial shape
- soft, extendable x-twist side arm technology offers adaptable, pressure-free comfort and a stable, non-slip fit
- soft side arm ends ensure a pressure-free and non-slip fit
- with proven uvex supravision lens coating technology
- metal-free

| uvex i-5 | | |
|--------------------------|--|---|
| Art. no. | 9183265 | 9183281 |
| Version | uvex supravision excellence | uvex supravision excellence sun protection |
| Standard | EN 166, EN 170 | EN 166, EN 172 |
| Frame | anthracite, blue W 166 FT CE | anthracite, lime W 166 FT CE |
| Lens | PC clear UV400 2C-1,2 W1 FTKN CE | PC grey 23% UV400 5-2,5 W1 FTKN CE |
| Weight | 29 g | 29 g |
| Order quantity multiples | 5 PC | 5 PC |

uvex x-fit pro
wearer comfort is clear to see



Optimally protected and perfectly equipped for almost every application: the uvex x-fit range of safety spectacles can be individually adjusted to meet your requirements. For greater safety and performance.



proErgo | uvex Comfort Slider
The flexible inclination of the side arms adapts ergonomically to all facial shapes – for optimum fit. Sliding the uvex Comfort Slider (A) adjusts the angle of the lens inclination (B)

uvex x-fit lens geometry
The innovative lens geometry ensures optimum fit. The x-design of the lens ensures additional stability – for full protection.

proGrip | uvex headband
The continuously adjustable, metal-free headband holds the safety spectacles securely in place. (art. no. 9958023)

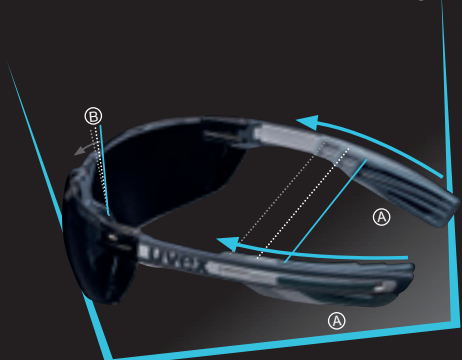

proComfort | uvex nose piece and side arms
The soft nose piece of the striking x-design offers maximum wearer comfort even when worn for extended periods of time.

uvex high-performance lens coating
uvex supravision coating technology with permanent anti-fog coating on the inside of the lens and scratch resistant outside ensures a perfect view.

proLux | uvex LED mini light
The bright, adjustable LED light ensures optimum vision even under poor light conditions. (art. no. 9999100)

proFix | uvex side arm system
Thanks to uvex duo component technology that combines hard and soft materials including the elastic side arms, ensures a pressure-free fit.

Functional accessories can be simply hooked onto the intelligent side arm system



Safety Spectacles

uvex x-fit pro



uvex x-fit pro

- Safety spectacles with a modern look
- innovative hinged side arm design
- soft nose piece with x-design for maximum wearer comfort
- elastic side arms ensure a pressure-free fit thanks to uvex duo component technology
- uvex Comfort Slider for flexible inclination of the side arms
- optimum fit thanks to innovative lens geometry
- flexible modular system allows attachment of functional accessories metal-free

Accessories:

- uvex LED mini light: bright, adjustable LED light with matching left or right adapter to be attached on uvex x-fit and x-fit pro side arms, batteries: four button cells, type L736F
- uvex x-fit headband: can be adapted on uvex x-fit and x-fit pro models

| uvex x-fit pro | | | | | | |
|---------------------------------|---------------------------------------|---|--|--|---|--|
| Art. no. | 9199005 | 9199247 | 9199245 | 9199240 | 9199277 | 9199276 |
| Version | uvex supravision sapphire | uvex supravision excellence without sliders | uvex supravision excellence | uvex supravision excellence contrast-enhancing | uvex supravision excellence sun protection, without sliders | uvex supravision excellence sun protection |
| Standard | EN 166, EN 170 | EN 166, EN 170 | EN 166, EN 170 | EN 166, EN 170 | EN 166, EN 172 | EN 166, EN 172 |
| Frame | white, anthracite W 166 FT CE | blue, anthracite W 166 FT CE | blue, anthracite W 166 FT CE | yellow, anthracite W 166 FT CE | anthracite, light grey W 166 FT CE | anthracite, light grey W 166 FT CE |
| Lens | PC clear UV400 2C-1,2 W1 FTK CE | PC clear UV400 2C-1,2 W1 FTKN CE | PC clear UV400 2C-1,2 W1 FTKN CE | PC amber UV400 2C-1,2 W1 FTKN CE | PC grey 23% UV400 5-2,5 W1 FTKN CE | PC grey 23% UV400 5-2,5 W1 FTKN CE |
| Weight | 28 g | 24 g | 28 g | 28 g | 24 g | 28 g |
| Order quantity multiples | 5 PC | 5 PC | 5 PC | 5 PC | 5 PC | 5 PC |

| | | | |
|-------------------|--|---------------------------------|---|
| Art. no. | uvex mini LED light 9999100 | Art. no. | uvex x-fit pro Headband 9958023 |
| Version | including 2 adapters (left and right) | Version | for attaching on uvex x-fit and x-fit pro, metal-free |
| Colour | Adapter+housing: black Light: white | Colour | black |
| Order unit | PC | Order quantity multiples | 5 PC |

MADE IN GERMANY

uvex

uvex x-fit

Stability through x-design

The uvex x-fit weighs just 23 gram. This sporty safety spectacle cannot fail to impress with its optimum coverage of the eyes and high level of wearer acceptance.

The x-design of the lens and the translucent side arms make the uvex x-fit a real highlight.



Perfect fit and coverage of the whole eye area
suits all head sizes

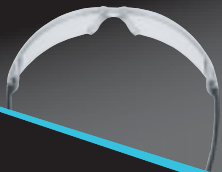

Lightweight safety spectacles
weighing just 23 grams

Innovative hinged side arm design
metal-free



x-design
for stability



uvex supravision coating technology

UV400 protection
also available in an amber lens
or as a sunglare filter lens

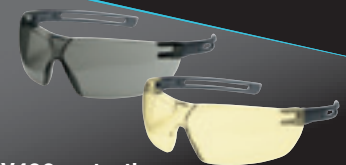

MADE IN GERMANY 



Safety Spectacles

uvex x-fit



9199085



9199265



9199123



9199286



9199280



9958024

uvex x-fit

- classic safety spectacles with optimum fit
- lightweight at just 23 grams
- uvex supravision coating technology
- innovative hinged side arm design with option of attaching the uvex Comfort Slider for an optimum fit
- metal-free

| uvex x-fit | | | | | |
|---------------------------------|---------------------------------------|--|--|--|--|
| Art. no. | 9199085 | 9199265 | 9199123 | 9199286 | 9199280 |
| Version | uvex supravision sapphire | uvex supravision excellence | uvex supravision excellence | uvex supravision excellence contrast-enhancing | uvex supravision excellence sunglare filter |
| Standard | EN 166, EN 170 | EN 166, EN 170 | EN 166, EN 170 | EN 166, EN 170 | EN 166, EN 172 |
| Frame | grey translucent W 166 FT CE | blue translucent W 166 FT CE | pink translucent W 166 FT CE | grey translucent W 166 FT CE | grey translucent W 166 FT CE |
| Lens | PC clear UV400 2C-1.2 W1 FTK CE | PC clear UV400 2C-1.2 W1 FTKN CE | PC clear UV400 2C-1.2 W1 FTKN CE | PC amber UV400 2C-1.2 W1 FTKN CE | PC grey 23% sunglare filter UV400 5-2.5 W1 FTKN CE |
| Weight | 23 g | 23 g | 23 g | 23 g | 23 g |
| Order quantity multiples | 5 PC | 5 PC | 5 PC | 5 PC | 5 PC |

| | |
|---------------------|---|
| uvex Comfort Slider | |
| Art. no. | 9958024 |
| Version | for attaching to uvex x-fit and x-fit pro side arms |
| Colour | anthracite |
| Order unit | BG |
| Content | 5 Pair |

uvex safety eyewear

Also ideal for narrow faces

The geometries of our spectacles are as different as the faces of the people who wear them. The products in this range can be worn by anyone, but are particularly suitable for people with narrow faces.

Their optimal fit and the fact that they can be adjusted mean that these safety spectacles fit different head shapes perfectly, providing the wearer with the best possible protection from particles, sparks or dust.

uvex has a range of safety eyewear
to meet every need —
including those
with narrower faces.

uvex spectacles:



uvex i-3 s 9190



uvex pheos s 9192



uvex sportstyle 9193



uvex i-works 9194



uvex pheos cx2 9198



uvex x-fit 9199

uvex goggles:



uvex pheos s guard 9192



uvex carbonvision 9307



uvex u-sonic 9308



uvex pheos cx2 sonic 9309





Safety Spectacles

uvex sportstyle

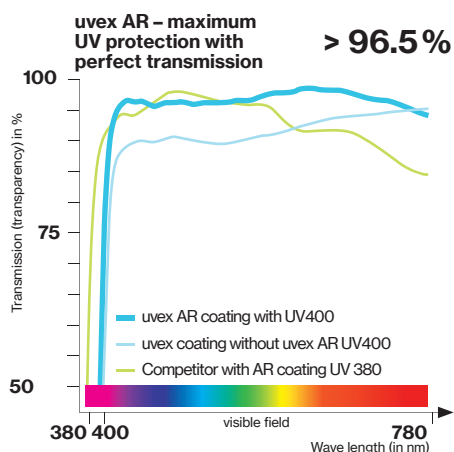

uvex sportstyle

- featherlight safety spectacles with a sporty design
- optimum vision thanks to uvex lens geometry
- soft, adjustable nose piece and soft, non-slip ear pieces (uvex duo component technology) ensure a secure, pressure-free fit
- uvex supravision coating technology

| uvex sportstyle | | | | | | | | |
|----------------------------------|--------------------------|-----------------------------|--------------------------|--|--------------------------|--------------------------|--|---|
| Art. no. | 9193080 | 9193265 | 9193376 | 9193838 | 9193064 | 9193280 | 9193885 | 9193880 |
| Design | uvex supravision extreme | uvex supravision excellence | uvex supravision extreme | uvex supravision AR super anti-reflective lenses | uvex supravision extreme | uvex supravision extreme | AF on the inside sun protection, silver mirror | uvex supravision variomatic self-tinting lenses |
| Standard | EN 166, EN 172 | EN 166, EN 170 | EN 166, EN 170 | EN 166, EN 170 | EN 166, EN 172 | EN 166, EN 172 | EN 166, EN 172 | EN 166, EN 170 |
| Frame | white, black | black, lime | black, petrol | black, blue | white, black | white, black | black, grey | black, anthracite |
| Lens | W 166 FT CE | W 166 FT CE | W 166 FT CE | W 166 FT CE | W 166 FT CE | W 166 FT CE | W 166 FT CE | W 166 FT CE |
| | PC grey 23% | PC clear | PC clear | PC clear | PC CBR65 | PC grey 23% | PC silver mirror, grey | PC light green |
| | UV400 | UV400 | UV400 | UV400 | UV400 | UV400 | UV400 | UV400 |
| | 5-2.5 W1 FTKN CE | 2C-1.2 W1 FTKN CE | 2C-1.2 W1 FTKN CE | 2C-1.2 W1 FT CE | 5-1.4 W1 FTKN CE | 5-2.5 W1 FTKN CE | 5-3,1 W1 FTN CE | 2-1.2 W1 FTKN CE |
| Weight | 23 g | 23 g | 23 g | 23 g | 23 g | 23 g | 23 g | 23 g |
| Order quantity multiples/ | 5 PC | 5 PC | 5 PC | 5 PC | 5 PC | 5 PC | 5 PC | PC |
| Order unit | | | | | | | | |

MADE IN GERMANY

Safety Spectacles

uvex pheos cx2



9198275
9198257



9198258



9198261
9198256



9198285



9198064



9198237



9198885

uvex pheos cx2

- x-branded safety spectacles with a modern, sporty design
- comfortable protection with the x-tended eyeshield
- x-twist side arm technology delivers non-slip fit for optimum protection
- duo-spherical lens delivers excellent field of vision
- large field of vision
- innovative uvex duo component technology for maximum wearer comfort
- can easily be combined with other PPE
- uvex supravision coating technology

► Also available as wide-vision goggles (see page 50)



| uvex pheos cx2 | | | | | |
|--------------------------|---------------------------------------|--|--|--|--|
| Art. no. | 9198275 | 9198257 | 9198258 | 9198256 | 9198261 |
| Version | uvex supravision sapphire | uvex supravision excellence | uvex supravision excellence | uvex supravision excellence | uvex supravision extreme |
| Standard | EN 166, EN 170 | EN 166, EN 170 | EN 166, EN 170 | EN 166, EN 170 | EN 166, EN 170 |
| Frame | blue, grey W 166 FT CE | blue, grey W 166 FT CE | red, grey W 166 FT CE | black, light blue W 166 FT CE | black, light blue W 166 FT CE |
| Lens | PC clear UV400 2C-1.2 W1 FTK CE | PC clear UV400 2C-1.2 W1 FTKN CE | PC clear UV400 2C-1.2 W1 FTKN CE | PC clear UV400 2C-1.2 W1 FTKN CE | PC clear UV400 2C-1.2 W1 FTKN CE |
| Weight | 28 g | 28 g | 28 g | 28 g | 28 g |
| Order quantity multiples | 5 PC | 5 PC | 5 PC | 5 PC | 5 PC |

| uvex pheos cx2 | | | | |
|--------------------------|--|---|---|--|
| Art. no. | 9198285 | 9198064 | 9198237 | 9198885 |
| Version | uvex supravision excellence contrast-enhancing | uvex supravision excellence sunglare filter | uvex supravision excellence sunglare filter | AF on the inside sunglare filter silver mirror |
| Standard | EN 166, EN 170 | EN 166, EN 172 | EN 166, EN 172 | EN 166, EN 172 |
| Frame | black, yellow W 166 FT CE | white, black W 166 FT CE | white, black W 166 FT CE | blue, grey W 166 FT CE |
| Lens | PC amber UV400 2C-1.2 W1 FTKN CE | PC CBR65 UV400 5-1.4 W1 FTKN CE | PC grey 23% UV400 5-2.5 W1 FTKN CE | PC silver mirror, grey UV400 5-3.1 W1 FTKN CE |
| Weight | 28 g | 28 g | 28 g | 28 g |
| Order quantity multiples | 5 PC | 5 PC | 5 PC | 5 PC |



Safety Spectacles

uvex pheos



uvex pheos

- modern safety spectacles with a fashionable design and duo-spherical lens technology
- metal-free
- available in standard size or a narrow version
- set consisting of fitted extra frame with soft padding and adapted headband (uvex pheos guard)
- additional eyebrow protection with Eye plus Protection: a bevelled edge in upper area
- soft, non-slip ear pieces (uvex duo component technology) prevent pressure points
- very large field of vision
- can be easily combined with other PPE
- suitable for the uvex helmet IES (Integrated Eyewear System) see page 106



product design award



German Design Award

2012 ■ WINNER 2013

| uvex pheos | | | | | |
|--------------------------|--------------------------|-----------------------------|-----------------------------|--------------------------|-----------------------------------|
| Art. no. | 9192080 | 9192225 | 9192215 | 9192280 | 9192385 |
| Design | uvex supravision plus | uvex supravision excellence | uvex supravision excellence | uvex supravision extreme | uvex supravision excellence |
| | standard size, oil & gas | standard size | standard size | standard size | standard size, contrast-enhancing |
| Standard | EN 166, EN 170 | EN 166, EN 170 | EN 166, EN 170 | EN 166, EN 170 | EN 166, EN 170 |
| Frame | black, grey | black, green | light grey, grey | black, grey | black, yellow |
| | W 166 FT CE | W 166 FT CE | W 166 FT CE | W 166 FT CE | W 166 FT CE |
| Lens | PC clear | PC clear | PC clear | PC clear | PC amber |
| | UV400 | UV400 | UV400 | UV400 | UV400 |
| | 2C-1.2 W1 FTKN CE | 2C-1.2 W1 FTKN CE | 2C-1.2 W1 FTKN CE | 2C-1.2 W1 FTKN CE | 2C-1.2 W1 FTKN CE |
| Weight | 29 g | 29 g | 29 g | 29 g | 29 g |
| Order quantity multiples | 5 PC | 5 PC | 5 PC | 5 PC | 5 PC |

| uvex pheos | | | | |
|--------------------------|--------------------------------|--------------------------------|--------------------------------|---|
| Art. no. | 9192245 | 9192285 | 9192281 | 9192881 |
| Design | uvex supravision excellence | uvex supravision excellence | uvex supravision extreme | AF on the inside |
| | standard size, sunglare filter | standard size, sunglare filter | standard size, sunglare filter | standard size, sunglare filter, silver mirror |
| Standard | EN 166, EN 172 | EN 166, EN 172 | EN 166, EN 172 | EN 166, EN 172 |
| Frame | black, orange | black, grey | black, grey | light grey, grey |
| | W 166 FT CE | W 166 FT CE | W 166 FT CE | W 166 FT CE |
| Lens | PC grey 23% | PC grey 23% | PC grey 23% | PC silver mirror grey |
| | UV400 | UV400 | UV400 | UV400 |
| | 5-2.5 W1 FTKN CE | 5-2.5 W1 FTKN CE | 5-2.5 W1 FTKN CE | 5-1.7 W1 FTN CE |
| Weight | 29 g | 29 g | 29 g | 29 g |
| Order quantity multiples | 5 PC | 5 PC | 5 PC | 5 PC |

MADE IN GERMANY

Safety Spectacles

uvex pheos s · uvex pheos guard · uvex pheos s guard

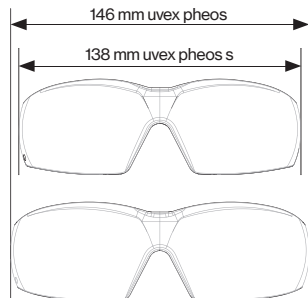

| Art. no. | uvex pheos s | | | | | |
|---------------------------------|--|--|---|---|--|--|
| 9192725 | 9192785 | 9192282 | 9192745 | 9192283 | 9192891 | |
| Design | uvex supravision excellence narrow version | uvex supravision excellence narrow version | uvex supravision extreme narrow version | uvex supravision excellence narrow version, sunglare filter | uvex supravision extreme narrow version, sunglare filter | AF on the inside narrow version, sunglare filter |
| Standard Frame | EN 166, EN 170 white, green | EN 166, EN 170 anthracite, grey | EN 166, EN 170 black, grey | EN 166, EN 172 white, orange | EN 166, EN 172 black, grey | EN 166, EN 172 light grey, grey |
| Lens | PC clear UV400 2C-1.2 W1 FTKN CE | PC clear UV400 2C-1.2 W1 FTKN CE | PC clear UV400 2C-1.2 W1 FTKN CE | PC grey 23% UV400 5-2.5 W1 FTKN CE | PC grey 23% UV400 5-2.5 W1 FTKN CE | PC silver mirror grey UV400 5-1.7 W1 FTN CE |
| Weight | 28 g | 28 g | 28 g | 28 g | 28 g | 28 g |
| Order quantity multiples | 5 PC | 5 PC | 5 PC | 5 PC | 5 PC | 5 PC |

| Art. no. | uvex pheos guard | | | uvex pheos s guard | | | Accessories | | |
|---------------------------------|---|--|--|--|---|--|-------------|-------|-------------|
| 9192180 | 9192181 | 9192680 | 9192001 | 9192002 | 9958020 | | | | |
| Design | uvex supravision extreme standard size incl. extra frame and headband | uvex supravision extreme standard size, sunglare filter incl. extra frame and headband | uvex supravision extreme narrow version incl. extra frame and headband | extra frame for uvex pheos standard size | extra frame for uvex pheos s narrow version | headband for uvex pheos and uvex pheos s | black | black | grey, black |
| Standard Frame | EN 166, EN 170 black, grey | EN 166, EN 172 black, grey | EN 166, EN 170 black, grey | black | black | | 5 PC | 5 PC | 5 PC |
| Lens | PC clear UV400 2C-1.2 W1 FTKN CE | PC grey 23% UV400 5-2.5 W1 FTKN CE | PC clear UV400 2C-1.2 W1 FTKN CE | | | | | | |
| Weight | 46 g | 46 g | 45 g | | | | | | |
| Order quantity multiples | 4 PC | 4 PC | 4 PC | | | | | | |

MADE IN GERMANY



Safety spectacles – matching your corporate identity

Eye protection with “personality”

Give your team an unmistakable image: uvex safety glasses offer various options for individual design – from printing your company’s logo on the side arms to frames in your company’s colours. You can coordinate your protective equipment perfectly with your corporate identity.

Frames in the company colours

“Your” safety spectacles are recognisable at first glance: the frames are designed in your company colours.

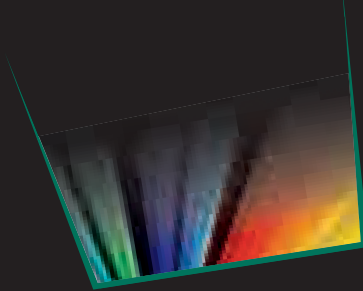

Insert in the side arms

Adding your company name to the soft components of the side arms is both bespoke and subtle.

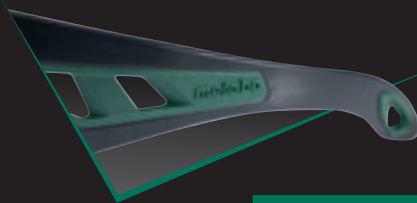

Pad printing on the side arms (1 to 4 colours)

The direct pad printing process is recommended for printing your logo in colour on the side arms.



How individual can you be?

We are happy to advise you personally on the technical options for customising our safety glasses. You can also use our online product configuration tool at www.uvex-safety.com/configurator

(or scan the QR code). Here you can choose and design the spectacle model online.

Please note that the following minimum quantities must be ordered:

- Pad printing – minimum of 500 pairs
- A combination of either lens and/or frame, with and without pad printing. Minimum 2500 units.
- Insert/customised corporate colouring/individual headband/laser engraving – minimum of 5,000 pairs
- Customised accessories available on request

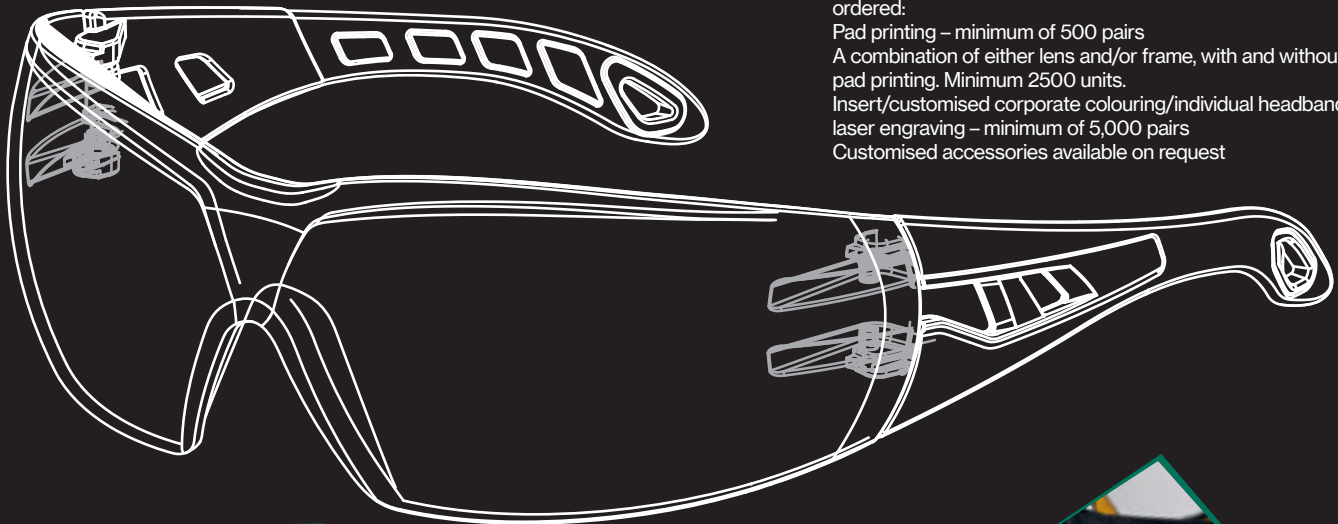

Customised accessories

Have your logo printed on your spectacle case.



Laser engraving on the lens

Safety spectacles will retain 100% of their functionality even with customised laser engraving.

Headband embroidery

Customise your spectacles by having your corporate logo embroidered on the headband.



Safety Spectacles

uvex i-3



uvex i-3 · uvex i-3 s

- fashionable, 3-component safety spectacles with innovative features
- metal-free
- available in standard size or a narrow version
- reliable protection provided by the customised fit: multi-level side arm inclination allows the wearer to adjust the spectacles to suit their own face shape
- soft, adjustable nose loops, soft, anti-slip sidearm pieces and metal-free hinged side arms (3-component technology) for high wearer comfort without pressure points

- Areas of application:
- uvex supravision AR: Working conditions with strong lighting or mixed lighting
 - uvex supravision variomatic: Offshore, maritime



| uvex i-3 | | | | | |
|--------------------------|---|--|---|--|---|
| Art. no. | 9190270 | 9190175 | 9190275 | 9190280 | 9190839 |
| Replacement lens | - | - | 9190258 | 9190258 | - |
| Design | uvex supravision sapphire standard size | uvex supravision plus standard size | uvex supravision excellence standard size | uvex supravision excellence standard size | uvex supravision AR standard size |
| Standard Frame | EN 166, EN 170 anthracite, blue W 166 FT CE | Oil & gas EN 166, EN 170 black, light grey W 166 FT CE | EN 166, EN 170 anthracite, blue W 166 FT CE | EN 166, EN 170 black, light grey W 166 FT CE | super anti-reflective lenses EN 166, EN 170 black, blue W 166 FT CE |
| Lens | PC clear UV400 2C-1.2 W1 FTK CE | PC clear UV400 2C-1.2 W1 FTKN CE | PC clear UV400 2C-1.2 W1 FTKN CE | PC clear UV400 2C-1.2 W1 FTKN CE | PC clear UV400 2C-1.2 W1 FT CE |
| Weight | 30 g | 30 g | 30 g | 30 g | 30 g |
| Order quantity multiples | 5 PC | 5 PC | 5 PC | 5 PC | 5 PC |

| uvex i-3 | | | | | Extra frame |
|--------------------------------------|---|--|---|--|--|
| Art. no. | 9190838 | 9190281 | 9190885 | 9190880 | 9190001 |
| Replacement lens | - | - | - | - | - |
| Design | uvex supravision AR standard size | uvex supravision excellence standard size | AF on the inside standard size | uvex supravision variomatic standard size | Extra frame for uvex i-3 standard size |
| Standard Frame | super anti-reflective lenses EN 166, EN 170 black, blue W 166 FT CE | sunglare filter EN 166, EN 172 black, light grey W 166 FT CE | sunglare filter, silver mirror EN 166, EN 170 black, light grey W 166 FT CE | self-tinting lenses EN 166, EN 172 black, anthracite W 166 FT CE | black |
| Lens | PC clear UV400 2C-1.2 W1 FT CE | PC grey 23% UV400 5-2.5 W1 FTKN CE | PC silver mirror grey UV400 5-3,1 W1 FTN CE | PC light green UV400 2-1.2 W1 FTKN CE | - |
| Weight | 30 g | 30 g | 30 g | 30 g | - |
| Order quantity multiples/ Order unit | PC | 5 PC | 5 PC | 5 PC | 5 PC |

MADE IN GERMANY



Safety Spectacles

uvex i-3 s



9190065



9190080



9190075



9190039



9190085



9190086

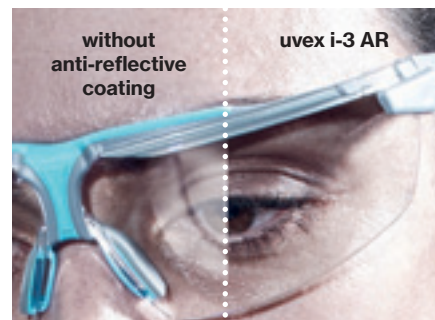

Coating

The anti-reflective coating on both sides provides 100% protection against UV400 and a transmission factor of more than 96.5%, which means distracting reflections are effectively prevented.

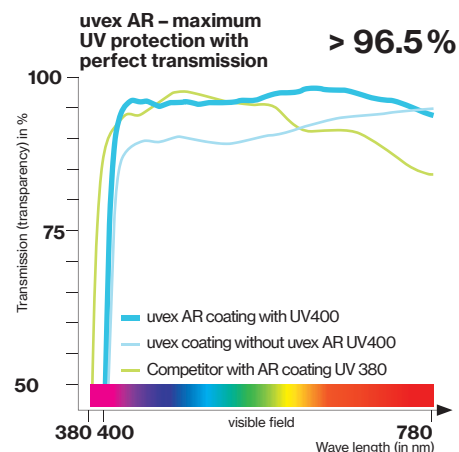

Transmission (transparency)

With the anti-reflective coating, the uvex i-3 AR reaches a higher transmission factor than safety spectacles with regular coating technology – ensuring perfect vision without reflections.

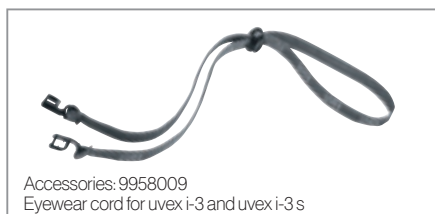
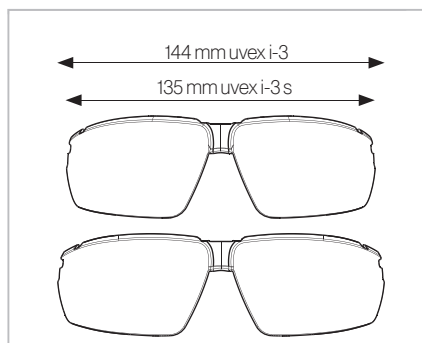

Accessories: 9958009
Eyewear cord for uvex i-3 and uvex i-3 s

| uvex i-3 s | | | |
|---------------------------------|--|---|--|
| Art. no. | 9190065 | 9190080 | 9190075 |
| Design | uvex supravision sapphire narrow version | uvex supravision plus narrow version Oil & gas | uvex supravision excellence narrow version |
| Standard | EN 166, EN 170 | EN 166, EN 170 | EN 166, EN 170 |
| Frame | blue, grey W 166 FT CE | black, grey W 166 FT CE | anthracite, lime W 166 FT CE |
| Lens | PC clear UV400 2C-1.2 W1 FTK CE | PC clear UV400 2C-1.2 W1 FTKN CE | PC clear UV400 2C-1.2 W1 FTKN CE |
| Weight | 29 g | 29 g | 29 g |
| Order quantity multiples | 5 PC | 5 PC | 5 PC |

| uvex i-3 s | | | | Accessories |
|---------------------------------|--|--|---|--|
| Art. no. | 9190039 | 9190085 | 9190086 | 9958009 |
| Design | uvex supravision AR narrow version super anti-reflective lenses | uvex supravision excellence narrow version contrast-enhancing | uvex supravision excellence narrow version sunglare filter | Eyewear cord for uvex i-3 and uvex i-3 s |
| Standard | EN 166, EN 170 | EN 166, EN 170 | EN 166, EN 172 | |
| Frame | black, blue W 166 FT CE | anthracite, yellow W 166 FT CE | blue, grey W 166 FT CE | anthracite, grey |
| Lens | PC clear UV400 2C-1.2 W1 FT CE | PC amber UV400 2C-1.2 W1 FTKN CE | PC grey 23% UV400 5-2.5 W1 FTKN CE | |
| Weight | 29 g | 29 g | 29 g | - |
| Order quantity multiples | 5 PC | 5 PC | 5 PC | 5 PC |

MADE IN GERMANY

Safety Spectacles

uvex i-works



9194171



9194175



9194365



9194270



9194885



uvex i-works

- safety spectacles with a sporty design: attractive appearance and robust quality
- metal-free
- uvex supravision coating technology

- duo component technology which combines hard and soft components, soft grip side arms, deliver non-slip fit without pressure points
- low profile side arms with practical hang cord attachment option
- can be easily combined with other PPE
- suitable for the uvex helmet IES (Integrated Eyewear System) see page 106

| uvex i-works | | | | | |
|---------------------------------|--|--|--|--|---|
| Art. no. | 9194171 | 9194175 | 9194365 | 9194270 | 9194885 |
| Version | uvex supravision excellence | uvex supravision excellence | uvex supravision excellence | uvex supravision excellence | AF on the inside sunglare filter |
| Standard | EN 166, EN 170 | EN 166, EN 170 | EN 166, EN 170 | EN 166, EN 172 | EN 166, EN 172 |
| Frame | anthracite, blue W 166 FT CE | anthracite, green W 166 FT CE | black, yellow W 166 FT CE | anthracite, grey W 166 FT CE | black, grey W 166 FT CE |
| Lens | PC clear UV400 2C-1.2 W1 FTKN CE | PC clear UV400 2C-1.2 W1 FTKN CE | PC amber UV400 2C-1.2 W1 FTKN CE | PC grey 23% UV400 5-2.5 W1 FTKN CE | PC silver mirror grey UV400 5-1.7 W1 FTN CE |
| Weight | 26 g | 26 g | 26 g | 26 g | 26 g |
| Order quantity multiples | 5 PC | 5 PC | 5 PC | 5 PC | 5 PC |

MADE IN GERMANY



Safety Spectacles

uvex astrospec 2.0



9164065



9164187



9164285



9164275



9164220



9164246



9164387

uvex astrospec 2.0

- innovative development of the world's most popular uvex astrospec spectacles
- reliable protection provided by its perfect fit: multi-level side arm inclination allows the wearer to adjust the spectacles to suit their own face shape
- panoramic lens with integrated side protectors for optimum protection of the whole eye area
- uvex ventilation system with labyrinth seal for enhanced eye comfort
- soft, non-slip sidearm pieces (uvex duo component technology) prevent pressure points
- fits easily into breast pocket due to flat-fold design



reddot award 2014
winner

| uvex astrospec 2.0 | | | | | | | |
|---------------------------------|---------------------------|-----------------------|-----------------------------|--------------------------|-----------------------------|-----------------------------|-----------------------------|
| Art. no. | 9164065 | 9164187 | 9164285 | 9164275 | 9164220 | 9164246 | 9164387 |
| Design | uvex supravision sapphire | uvex supravision plus | uvex supravision excellence | uvex supravision extreme | uvex supravision excellence | uvex supravision excellence | uvex supravision excellence |
| | | Oil & gas | | | contrast-enhancing | sunflare filter | sunflare filter |
| Standard | EN 166, EN 170 | EN 166, EN 170 | EN 166, EN 170 | EN 166, EN 170 | EN 166, EN 170 | EN 166, EN 172 | EN 166, EN 172 |
| Frame | blue, light blue | black, grey | black, lime | anthracite, petrol | black, yellow | neon orange, black | black, grey |
| | W 166 FT CE | W 166 FT CE | W 166 FT CE | W 166 FT CE | W 166 FT CE | W 166 FT CE | W 166 FT CE |
| Lens | PC clear, UV400 | PC clear, UV400 | PC clear, UV400 | PC clear, UV400 | PC amber, UV400 | PC grey 23%, UV400 | PC grey 14%, UV400 |
| | 2C-1.2 W1 FTK CE | 2C-1.2 W1 FTKN CE | 2C-1.2 W1 FTKN CE | 2C-1.2 W1 FTKN CE | 2C-1.2 W1 FTKN CE | 5-2.5 W1 FTKN CE | 5-3.1 W1 FTKN CE |
| Weight | 42 g | 42 g | 42 g | 42 g | 42 g | 42 g | 42 g |
| Order quantity multiples | 5 PC | 5 PC | 5 PC | 5 PC | 5 PC | 5 PC | 5 PC |

MADE IN GERMANY

Safety Spectacles

uvex super g



9172085



9172110
9172210



9172265



9172220



9172281

uvex super g

- extremely light protective spectacles with a sporty design and hingeless side arms
- soft nose piece
- maximum optical clarity thanks to extremely thin wrap-around lenses
- aerodynamically optimised lenses that are angled forwards to provide optimum ventilation
- maximum wear comfort is guaranteed by the lightweight design: just 18 grams
- metal-free

| uvex super g | | | | | | |
|---------------------------------|--------------------------------------|--|--|--|--|---|
| Art. no. | 9172085 | 9172110 | 9172210 | 9172265 | 9172220 | 9172281 |
| Replacement lens | - | - | 9172255 | 9172255 | - | - |
| Design | uvex supravision sapphire | uvex supravision plus | uvex supravision excellence | uvex supravision excellence | uvex supravision excellence contrast-enhancing | uvex supravision excellence sunglare filter |
| Standard | EN 166, EN 170 | EN 166, EN 170 | EN 166, EN 170 | EN 166, EN 170 | EN 166, EN 170 | EN 166, EN 172 |
| Frame | grey metallic, black W 166 FT CE | clear, grey W 166 FT CE | clear, grey W 166 FT CE | navy blue, white W 166 FT CE | grey metallic, black W 166 FT CE | anthracite, lime W 166 FT CE |
| Lens | PC clear UV400 2C-1.2 W1 FT CE | PC clear UV400 2C-1.2 W1 FTKN CE | PC clear UV400 2C-1.2 W1 FTKN CE | PC clear UV400 2C-1.2 W1 FTKN CE | PC amber UV400 2C-1.2 W1 FTKN CE | PC grey 23% UV400 5-2.5 W1 FTKN CE |
| Weight | 18 g | 18 g | 18 g | 18 g | 18 g | 18 g |
| Order quantity multiples | 5 PC | 5 PC | 5 PC | 5 PC | 5 PC | 5 PC |



Safety Spectacles

uvex super fit · uvex super fit ETC



uvex super fit

- lightweight safety spectacles with hinged side arms, a sporty design
- soft, adjustable nose piece
- soft, adjustable material around the nose bridge for a comfortable and pressure-free fit
- aerodynamically optimised lenses that are angled forwards to provide optimum ventilation
- excellent wearer comfort guaranteed by the lightweight design weighing just 21 grams

| uvex super fit | | | | |
|---------------------------------|--------------------------------------|--|--|--|
| Art. no. | 9178065 | 9178185 | 9178265 | 9178315 |
| Replacement lens | - | - | 9172255 | 9172255 |
| Design | uvex supravision sapphire | uvex supravision plus | uvex supravision excellence | uvex supravision excellence |
| Standard | EN 166, EN 170 | EN 166, EN 170 | EN 166, EN 170 | EN 166, EN 170 |
| Frame | navy blue, white W 166 FT CE | black, white W 166 FT CE | navy blue, white W 166 FT CE | white, lime W 166 FT CE |
| Lens | PC clear UV400 2C-1.2 W1 FT CE | PC clear UV400 2C-1.2 W1 FTKN CE | PC clear UV400 2C-1.2 W1 FTKN CE | PC clear UV400 2C-1.2 W1 FTKN CE |
| Weight | 21 g | 21 g | 21 g | 21 g |
| Order quantity multiples | 5 PC | 5 PC | 5 PC | 5 PC |

| uvex super fit | | | | |
|---------------------------------|---------------------------------------|---|--|---|
| Art. no. | 9178415 | 9178500 | 9178385 | 9178286 |
| Replacement lens | - | - | - | - |
| Design | uvex supravision ETC | uvex supravision clean autoclavable (15 cycles) | uvex supravision excellence contrast-enhancing | uvex supravision excellence sunglare filter |
| Standard | EN 166, EN 170 | EN 166, EN 170 | EN 166, EN 170 | EN 166, EN 172 |
| Frame | white, grey W 166 FT CE | white, light blue W 166 FT CE | black, white W 166 FT CE | black, white W 166 FT CE |
| Lens | PC clear UV400 2C-1.2 W1 FTN CE | PC clear UV400 2C-1.2 W1 FTKN CE | PC amber UV400 2C-1.2 W1 FTKN CE | PC grey 23% UV400 5-2.5 W1 FTKN CE |
| Weight | 21 g | 21 g | 21 g | 21 g |
| Order quantity multiples | 5 PC | 5 PC | 5 PC | 5 PC |

Areas of application:

- uvex supravision clean: sterile working environments (laboratories, hospitals, clean rooms, food production)
- uvex supravision ETC on both sides: high humidity and alternating temperatures (cold stores, tunnel construction, catering and food industry)

uvex supravision ETC-coated lenses do not fog up. Instead of droplets, a film of water forms on the lens.

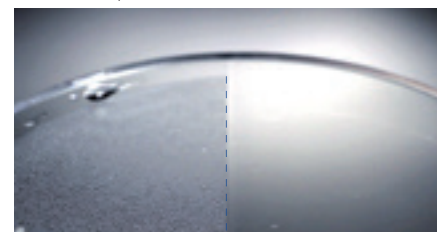

Anti-fog coating after 8 sec. | uvex supravision ETC

MADE IN GERMANY

Safety Spectacles

uvex i-vo



uvex i-vo

- functional safety spectacles with adjustable side arms
- reliable protection provided by its perfect fit: multi-level side arm inclination and different side arm lengths allow the wearer to adjust the spectacles to suit their own face shape
- soft, uvex quattroflex arms and soft components at the nose and forehead ensure a comfortable, pressure-free fit
- the shape of the lenses ensures unrestricted peripheral vision

| uvex i-vo | | | | | |
|--------------------------|--------------------------------------|--|--|--|--|
| Art. no. | 9160065 | 9160185 | 9160285 | 9160265 | 9160275 |
| Replacement lens | 9160055 | - | 9160255 | 9160255 | 9160255 |
| Design | uvex supravision sapphire | uvex supravision plus | uvex supravision excellence | uvex supravision excellence | uvex supravision excellence |
| Standard | EN 166, EN 170 | EN 166, EN 170 | EN 166, EN 170 | EN 166, EN 170 | EN 166, EN 170 |
| Frame | blue, orange W 166 FT CE | blue, grey W 166 FT CE | blue, grey W 166 FT CE | blue, orange W 166 FT CE | black, grey W 166 FT CE |
| Lens | PC clear UV400 2C-1.2 W1 FT CE | PC clear UV400 2C-1.2 W1 FTKN CE | PC clear UV400 2C-1.2 W1 FTKN CE | PC clear UV400 2C-1.2 W1 FTKN CE | PC clear UV400 2C-1.2 W1 FTKN CE |
| Weight | 33 g | 33 g | 33 g | 33 g | 33 g |
| Order quantity multiples | 5 PC | 5 PC | 5 PC | 5 PC | 5 PC |

| | | | | | |
|--------------------------|---|--|--|--|--|
| Art. no. | 9160520 | 9160068 | 9160268 | 9160076 | 9160120 |
| Replacement lens | 9160052 | - | - | 9160318 | 9160255 |
| Design | uvex supravision sapphire contrast-enhancing | uvex supravision sapphire sunglare filter | uvex supravision excellence sunglare filter | uvex supravision sapphire sunglare filter | uvex supravision excellence with headband |
| Standard | EN 166, EN 170 | EN 166, EN 172 | EN 166, EN 172 | EN 166, EN 172 | EN 166, EN 170 |
| Frame | blue, orange W 166 FT CE | blue, orange W 166 FT CE | blue, orange W 166 FT CE | black, grey W 166 FT CE | blue, grey - |
| Lens | PC amber UV400 2C-1.2 W1 FT CE | PC brown UV400 5-2.5 W1 FT CE | PC brown UV400 5-2.5 W1 FTKN CE | PC grey 23% UV400 5-2.5 W1 FT CE | PC clear UV400 2C-1.2 W1 FTKN 166 F CE |
| Weight | 33 g | 33 g | 33 g | 33 g | 32 g |
| Order quantity multiples | 5 PC | 5 PC | 5 PC | 5 PC | 5 PC |

Safety Spectacles

uvex skyper · uvex skyper sx2



9195075



9195265



9195078

uvex skyper

- individually adjustable safety spectacles
- reliable protection provided by its perfect fit: multi-level side arm inclination and five different side arm lengths allow the wearer to adjust the spectacles to suit their own face shape
- sides protect against glare

| uvex skyper | | | |
|--------------------------|---------------------------|-----------------------------|---|
| Art. no. | 9195075 | 9195265 | 9195078 |
| Replacement lens | - | 9195255 | - |
| Design | uvex supravision sapphire | uvex supravision excellence | uvex supravision sapphire sunglare filter |
| Standard | EN 166, EN 170 | EN 166, EN 170 | EN 166, EN 172 |
| Frame | black | blue | black |
| | W 166 F CE | W 166 F CE | W 166 F CE |
| Lens | PC clear | PC clear | PC brown |
| | UV400 | UV400 | UV400 |
| | 2C-1.2 W1 F CE | 2C-1.2 W1 FKN CE | 5-2.5 W1 F CE |
| Weight | 29 g | 29 g | 29 g |
| Order quantity multiples | 5 PC | 5 PC | 5 PC |



9197065
9197265



9197266

uvex skyper sx2

- safety spectacles with special lens shape for prominent cheekbones
- reliable protection provided by its perfect fit: multi-level side arm inclination and five different side arm lengths allow the wearer to adjust the spectacles to suit their own face shape
- sides protect against glare

| uvex skyper sx2 | | | |
|--------------------------|---------------------------|-----------------------------|-----------------------------|
| Art. no. | 9197065 | 9197265 | 9197266 |
| Design | uvex supravision sapphire | uvex supravision excellence | uvex supravision excellence |
| Standard | EN 166, EN 170 | EN 166, EN 170 | EN 166, EN 172 |
| Frame | blue | blue | blue |
| | W 166 F CE | W 166 F CE | W 166 F CE |
| Lens | PC clear | PC clear | PC grey 23% |
| | UV400 | UV400 | UV400 |
| | 2C-1.2 W1 F CE | 2C-1.2 W1 FKN CE | 5-2.5 W1 FKN CE |
| Weight | 30 g | 30 g | 30 g |
| Order quantity multiples | 5 PC | 5 PC | 5 PC |

Safety Spectacles

uvex cybric · uvex cyberguard · uvex meteor · uvex futura



9188075
9188175

9188076

9188121

uvex cybric · uvex cyberguard

- sporty, twin-lens safety spectacles
- large face coverage
- reliable protection provided by its perfect fit: multi-level side arm inclination allows the wearer to adjust the spectacles to suit their own face shape
- uvex quattroflex side arms with four comfort cushions to ensure a comfortable, pressure-free fit around the ears
- uvex cyberguard with protection class 3 (liquids) and 4 (coarse dust particles)

| | uvex cybric | uvex cyberguard |
|---------------------------------|---------------------------|--|
| Art. no. | 9188075 | 9188121 |
| Design | uvex supravision sapphire | uvex supravision plus with headband and all-round seal |
| Standard | EN 166, EN 170 | EN 166, EN 170 |
| Frame | black, orange | black |
| Lens | PC clear UV400 | PC clear UV400 |
| Weight | 28 g | 35 g |
| Order quantity multiples | 5 PC | 5 PC |



9134005
9134002



9180015
9180125

uvex meteor

- classic, twin-lens spectacles
- reliable protection provided by its perfect fit: adjustable side arms allow the wearer to adjust the spectacles to suit their own face shape
- flat design allows it to easily fit into a breast pocket

| uvex meteor | | |
|---------------------------------|---------------------------|--------------------|
| Art. no. | 9134005 | 9134002 |
| Design | uvex supravision sapphire | uncoated |
| | lens 56 mm | lens 56 mm |
| | bridge width 15 mm | bridge width 15 mm |
| Standard | EN 166, EN 170 | EN 166 |
| Frame | grey, transparent | grey transparent |
| | W 166 F CE | W 166 F CE |
| Lens | PC clear UV400 | HG clear UV 330 |
| | 2-1.2 W1 FK | W1 S |
| Weight | 28 g | 44 g |
| Order quantity multiples | 5 PC | 5 PC |

uvex futura

- classic spectacles with large field of vision
- reliable protection provided by its customised fit: multi-level side arm inclination and four different side arm lengths allow the wearer to adjust the spectacles to suit their facial requirements
- soft, duo-flex ear pieces increase comfort

| uvex futura | | |
|---------------------------------|---------------------------|-----------------------|
| Art. no. | 9180015 | 9180125 |
| Replacement lens | 9180055 | 9180155 |
| Design | uvex supravision sapphire | uvex supravision plus |
| Standard | EN 166, EN 170 | EN 166, EN 170 |
| Frame | brown | brown |
| | W 166 F CE | W 166 F CE |
| Lens | PC clear UV400 | PC clear UV400 |
| | 2-1.2 W1 FK CE | 2-1.2 W1 FKN CE |
| Weight | 49 g | 49 g |
| Order quantity multiples | 5 PC | 5 PC |



Safety Spectacles

uvex polavision · uvex skyguard NT



9231960

uvex polavision

- comfortable safety spectacles with polarisation filter
- polarisation filter to protect against reflections and glare (e.g. water surfaces and highly polished materials)
- eliminates bright, annoying reflected glare allowing the wearer to see more comfortably

Areas of application:

- workstations with reflective surfaces (offshore, maritime, drivers, construction industry)

| | |
|-------------------|---|
| uvex polavision | |
| Art. no. | 9231960 |
| Design | on both sides scratch-resistant sunglare filter |
| Standard | EN 166, EN 172 |
| Frame | black, white W 166 F CE |
| Lens | PC grey 14% UV400 5-3:1 W 1 F CE |
| Weight | 25 g |
| Order unit | PC |



9175275



9175260
9175160



9175261

MADE IN GERMANY

uvex skyguard NT

- spectacles with all-round protection
- Injection-moulded, soft TPU seal protects against flying particles, dust and splash (protection class 3 – liquids and 4 – coarse dust particles)
- reliable protection provided by its customised fit: multi-level side arm lengths allow the wearer to adjust the spectacles to suit their own face shape
- flexible soft component adapts to the wearer's face contours

| | | | | |
|---------------------------------|--------------------------------------|--------------------------------------|--------------------------------------|---|
| uvex skyguard NT | | | | |
| Art. no. | 9175275 | 9175260 | 9175160 | 9175261 |
| Design | uvex supravision excellence | uvex supravision excellence | uvex supravision extreme | uvex supravision excellence sunglare filter |
| Standard | EN 166, EN 170 | EN 166, EN 170 | EN 166, EN 170 | EN 166, EN 172 |
| Frame | orange, grey W 166 34 F CE | blue, grey W 166 34 F CE | blue, grey W 166 34 F CE | blue, grey W 166 34 F CE |
| Lens | PC clear UV400 2-1.2 W1 FKN CE | PC clear UV400 2-1.2 W1 FKN CE | PC clear UV400 2-1.2 W1 FKN CE | PC grey 23% UV400 5-2.5 W1 FKN CE |
| Weight | 42 g | 44 g | 44 g | 44 g |
| Order quantity multiples | 5 PC | 5 PC | 5 PC | 5 PC |

Safety Spectacles

uvex winner · uvex mercury · uvex ceramic



uvex winner

- edgeless, metal-framed spectacles with sprung side arms
- optimum eye coverage
- anatomically adjustable, soft nose pads

| uvex winner | | | | | |
|---------------------------------|-------------------------------------|--------------------------------------|-------------------------------------|--------------------------------------|--|
| Art. no. | 9159005 | 9159105 | 9159016 | 9159116 | 9159118 |
| Design | scratch-resistant on both sides | scratch-resistant, anti-fog | scratch-resistant on both sides | scratch-resistant, anti-fog | scratch-resistant, anti-fog sunglare filter |
| Standard Frame | EN 166, EN 170 gun W 166 F CE | EN 166, EN 170 gun W 166 F CE | EN 166, EN 170 gun W 166 F CE | EN 166, EN 170 gun W 166 F CE | EN 166, EN 172 gun W 166 F CE |
| Lens | PC clear UV400 2-1.2 W1 F CE | PC clear UV400 2-1.2 W1 FKN CE | PC green UV400 2-1.7 W1 F CE | PC green UV400 2-1.7 W1 FKN CE | PC grey 23% UV400 5-2.5 W1 FKN CE |
| Weight | 29 g | 29 g | 29 g | 29 g | 29 g |
| Order quantity multiples | 5 PC | 5 PC | 5 PC | 5 PC | 5 PC |



MADE IN GERMANY 



MADE IN GERMANY 

uvex mercury

- slim metal-framed safety spectacles
- transparent side protection with excellent peripheral vision
- fit easily into breast pocket due to flat design

| uvex mercury | |
|---------------------------------|---|
| Art. no. | 9155005 |
| Design | uvex supervision sapphire lens 56 mm bridge width 19 mm |
| Standard Frame | EN 166, EN 170 steel blue W 166 F CE |
| Lens | PC clear UV400 2-1.2 W1 FK CE |
| Weight | 30 g |
| Order quantity multiples | 5 PC |

uvex ceramic

- safety spectacles with in two-lens design
- specifically for narrow faces
- a combination of a plastic side shields with a metal frame

| uvex ceramic | |
|---------------------------------|---|
| Art. no. | 9137005 |
| Design | uvex supervision sapphire lens 49 mm bridge width 20 mm |
| Standard Frame | EN 166, EN 170 grey, black W 166 F CE |
| Lens | PC clear UV400 2C-1.2 W1 FK CE |
| Weight | 23 g |
| Order quantity multiples | 5 PC |

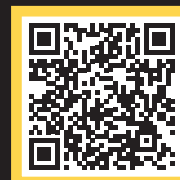

You can find more information at uvex-academy.com

A practical introductory seminar on the selection, use and benefits of protective eyewear

- The basic applications of safety eyewear, including which products protect against mechanical dangers, chemical and radiation risks (e.g. welding protection), and products designed for specialised applications
- Demonstration and assessment of the dangers posed by mechanical risks, infrared and ultraviolet radiation (e.g. encountered during welding applications or during the use of chemicals), illustrated by case studies
- Assessment of the risk of eye injury in the workplace
- Explanation of how these risks can be dealt with efficiently in each workplace
- Comprehensive overview of the requirements of industrial safety eyewear, standards, applications, risk assessment and how to care for protective eyewear
- Information on the classification of protection products based on their labelling and the areas of application of the various types of equipment

Target group

Those responsible for the work-related health and safety of employees within a company, e.g. health and safety officers, occupational nurses and specialist purchasers



For more information or to book a place, please visit uvex-academy.de, call +49 (0)911 9736 1710 or email academy@uvex.de

Overspecs

uvex 9161 · uvex super OTG



9161014



9161005
9161305

uvex 9161

- overspecs for prescription spectacle wearers
- panoramic lens with integrated side protection for optimum eye coverage
- adjustable side arms adapt to any facial shape for customised fit and optimum protection
- unrestricted peripheral vision
- uvex duoflex side arms for a pressure free fit

| uvex 9161 | | | |
|---------------------------------|-----------------|---------------------------|-----------------------|
| Art. no. | 9161014 | 9161005 | 9161305 |
| Version | without coating | uvex supravision sapphire | uvex supravision plus |
| Standard | EN 166, EN 170 | EN 166, EN 170 | EN 166, EN 170 |
| Frame | clear | blue, black | blue, black |
| | W 166 F CE | W 166 F CE | W 166 F CE |
| Lens | PC clear | PC clear | PC clear |
| | UV400 | UV400 | UV400 |
| | 2C-1.2 W1 F CE | 2C-1.2 W1 F CE | 2C-1.2 W1 F CE |
| Weight | 51 g | 46 g | 46 g |
| Order quantity multiples | 5 PC | 5 PC | 5 PC |



9169065
9169260



9169080



9169081

uvex super OTG

- overspecs for prescription spectacle wearers
- panoramic lens with integrated side protection for optimum coverage of the eye area
- metal-free
- highly flexible, hinge-less side arms for added comfort and non-slip fit

| uvex super OTG | | | | |
|---------------------------------|---------------------------|---------------------------|-----------------------------|--|
| Art. no. | 9169065 | 9169080 | 9169260 | 9169081 |
| Version | uvex supravision sapphire | uvex supravision sapphire | uvex supravision excellence | uvex supravision sapphire sunglare filter |
| Standard | EN 166, EN 170 | EN 166, EN 170 | EN 166, EN 170 | EN 166, EN 172 |
| Frame | blue, light grey | black, light grey | blue, light grey | black, light grey |
| | W 166 FT CE | W 166 FT CE | W 166 FT CE | W 166 FT CE |
| Lens | PC clear | PC clear | PC clear | PC grey 23% |
| | UV400 | UV400 | UV400 | UV400 |
| | 2C-1.2 W1 FT CE | 2C-1.2 W1 FT CE | 2C-1.2 W1 FTKN CE | 5-2.5 W1 FT CE |
| Weight | 37 g | 37 g | 37 g | 37 g |
| Order quantity multiples | 5 PC | 5 PC | 5 PC | 5 PC |

Overspecs

uvex super f OTG



9169585
9169261



9169500



9169580



9169164



9169586



9169850



9169615

uvex super f OTG

- overspecs for prescription wearers
- panoramic lens with integrated side protection for optimum eye coverage
- side arms graduate to soft, flexible material for added comfort and grip

| uvex super f OTG | | | | | | | | |
|---|---|---|---|--|---|---|---|---|
| Art. no. | 9169585 | 9169261 | 9169500 | 9169580 | 9169164 | 9169586 | 9169850 | 9169615 |
| Version | uvex supravision sapphire | uvex supravision excellence | uvex supravision clean autoclavable (15 cycles) | uvex supravision sapphire contrast-enhancing | uvex supravision excellence sunglare filter | uvex supravision sapphire sunglare filter | uvex supravision variomatic | uvex supravision sapphire blocks blue light to 525 nm |
| Standard Frame | EN 166, EN 170 black, white W 166 FT CE | EN 166, EN 170 black, white W 166 FT CE | EN 166, EN 170 white, light blue W 166 FT CE | EN 166, EN 170 black, white W 166 FT CE | EN 166, EN 172 black, white W 166 FT CE | EN 166, EN 172 black, white W 166 FT CE | EN 166, EN 170 black, white W 166 FT CE | EN 166, EN 170 black, white W 166 FT CE |
| Lens | PC clear UV400 2C-1.2 W1 FT CE | PC clear UV400 2C-1.2 W1 FTKN CE | PC clear UV400 2C-1.2 1FTKN CE | PC amber UV400 2C-1.2 W1 FT CE | PC CBR65 UV400 5-1.4 W1 FT KN CE | PC grey 23% UV400 5-2.5 W1 FT CE | PC light green UV400 2-1.2 W1 FTKN CE | PC orange UV 525 2-1.4 W1 FT CE |
| Weight | 39 g | 39 g | 39 g | 39 g | 39 g | 39 g | 39 g | 39 g |
| Order quantity multiples/ Order unit | 5 PC | 5 PC | 5 PC | 5 PC | 5 PC | 5 PC | PC | 5 PC |

MADE IN GERMANY

uvex

uvex megasonic

Visionary technologies at a glance

The uvex megasonic's revolutionary lens design does not restrict the wearer's field of vision, meaning users have the clearest possible view at all times – even under difficult conditions. It has a sporty, ergonomic design and is extremely comfortable to wear, making it a piece of equipment you can depend on during your everyday work.



Frameless and innovative lens design
for an optimum, unrestricted view



x-frame design
for flexible adjustment
to any face

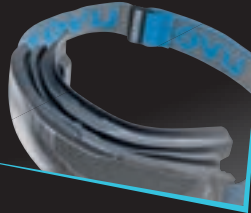

Ergonomic face piece
for a perfect fit and
maximum comfort

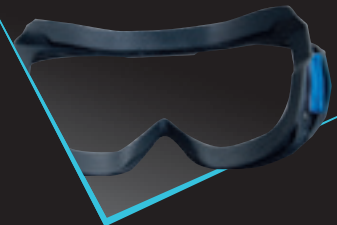

**Fits comfortably over most prescription
glasses**
thanks to the unique frame design

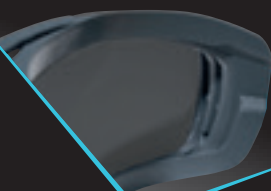

uvex supravision
coating technology



Extra-wide headband
for an optimal fit and
extra wearer comfort

MADE IN GERMANY 



Safety Goggles

uvex megasonic



9320265



9320281



Further information can be found at uvex-safety.com/en/megasonic (or scan the QR code).

uvex megasonic

- revolutionary goggles with exceptional field of vision
- unique frameless lens design
- OTG compatible with frame recess for side arms
- soft, adaptive face seal for incredible comfort and fit
- 30-mm-wide headband for a superior, no pressure fit
- easily interchangeable headband and lens
- highly compatible with other items of PPE
- uvex's proven supravision coating technology

| uvex megasonic | | |
|--------------------------|--|---|
| Art. no. | 9320265 | 9320281 |
| Version | uvex supravision excellence | uvex supravision excellence |
| Standard | EN 166, EN 170 | EN 166, EN 172 |
| Frame | anthracite, blue W 166 34 BT CE | anthracite, lime W 166 34 BT CE |
| Lens | PC clear UV400 2C-1.2 W1 BTKN CE | sunglare filter PC grey 23% UV400 5-2.5 W1 BTKN CE |
| Weight | 96 g | 96 g |
| Order quantity multiples | 4 PC | 4 PC |

MADE IN GERMANY

Safety Goggles

uvex pheos cx2 sonic



9309275



9309064



9309286

uvex pheos cx2 sonic

- uvex's lightest compact wide-vision goggles (34 grams)
- high mechanical strength B (120 m/s)
- designation 3 (liquids), 4 (coarse dust) and T (extreme temperatures)
- comfortable protection thanks to soft forehead and nose piece moulded directly onto the lens
- very soft, light textile headband for secure and comfortable fit
- can be easily combined with other PPE

| uvex pheos cx2 sonic | | | |
|---------------------------------|--|---|---|
| Art. no. | 9309275 | 9309064 | 9309286 |
| Version | uvex supravision extreme | uvex supravision extreme sunglare filter | uvex supravision extreme sunglare filter |
| Standard | EN 166, EN 170 | EN 166, EN 172 | EN 166, EN 172 |
| Frame | white, black W 166 34 BT CE | white, black W 166 34 BT CE | white, black W 166 34 BT CE |
| Lens | PC clear UV400 2C-1.2 W1 BTKN CE | PC CBR65 UV400 5-1.4 W1 BTKN CE | PC grey 23% UV400 5-2.5 W1 BTKN CE |
| Weight | 34 g | 34 g | 34 g |
| Order quantity multiples | 5 PC | 5 PC | 5 PC |

MADE IN GERMANY 



Safety Goggles

uvex u-sonic



uvex u-sonic

- compact low weight goggle
- highly compatible with other PPE
- ergonomic design with soft flexible components – adapts to any facial shape
- high mechanical strength (B: 120 m/s)
- low pressure, wide fully adjustable head strap for excellent wearer comfort
- low weight

| uvex u-sonic | | | | | | |
|---------------------------------|---------------------------------------|---------------------------------------|---------------------------------------|--|---|--|
| Art. no. | 9308147 | 9308245 | 9308123 | 9308247 | 9308246 | 9308240 |
| Version | uvex supravision plus Oil & gas | uvex supravision excellence | uvex supravision excellence | uvex supravision excellence reduced ventilation | uvex supravision extreme reduced ventilation | uvex supravision excellence sunglare filter |
| Standard | EN 166, EN 170 | EN 166, EN 170 | EN 166, EN 170 | EN 166, EN 170 | EN 166, EN 170 | EN 166, EN 172 |
| Frame | black, grey W 166 34 B CE | anthracite, lime W 166 34 B CE | anthracite, pink W 166 34 B CE | black, red W 166 34 B CE | anthracite, yellow W 166 34 B CE | anthracite, lime W 166 34 B CE |
| Lens | PC clear UV400 2C-1.2 W1 BKN CE | PC clear UV400 2C-1.2 W1 BKN CE | PC clear UV400 2C-1.2 W1 BKN CE | PC clear UV400 2C-1.2 W1 BKN CE | PC clear UV400 2C-1.2 W1 BKN CE | PC grey 23% UV400 5-2.5 W1 BKN CE |
| Weight | 72 g | 72 g | 72 g | 71 g | 71 g | 72 g |
| Order quantity multiples | 5 PC | 5 PC | 5 PC | 5 PC | 5 PC | 5 PC |

| | | |
|---------------------------------|---|-------------------------------------|
| uvex u-sonic | | Add-on lens |
| Art. no. | 9308248 | 9308048 |
| Version | uvex supravision excellence with add-on lens grey 14% and magnetic headband | sunglare filter |
| Standard | EN 166, EN 170, EN 172 | EN 166, EN 172 |
| Frame | grey, orange W 166 34 B CE | |
| Lens | PC clear UV400 2C-1.2 W 1 BKN CE | PC grey 16% UV400 5-3.1 W1 CE |
| Add-on lens | uvex supravision sapphire PC grey 14% sunglare filter, UV400 5-3.1 W1 CE | |
| Weight | 107 g | - |
| Order quantity multiples | 5 PC | 5 PC |



MADE IN GERMANY

uvex CR

Autoclave safety eyewear that goes further

Innovative coating technology –
the first autoclavable
safety eyewear with
anti-fog performance

uvex has developed the first autoclavable safety eyewear with anti-fog coating for specialist requirements in laboratories, clinics, cleanrooms and food manufacturing. From ultra-light safety spectacles and goggles with a panoramic lens, the uvex CR is the ideal safety eyewear for all areas of application and specifically have been designed for repeated autoclave sterilisation (15 to 20 times for 20 minutes each at a max. of 121°C).

**uvex CR – professional safety eyewear
that compliments hygiene standards.**



9178500

9169500

9302500

uvex super fit CR

- lightweight safety spectacles with hinged side arms and a sporty design
- maximum optical clarity thanks to extremely thin wrap-around lenses
- aerodynamically optimised lenses that are angled forwards to provide optimum ventilation and comfort around the eyes
- excellent wear comfort guaranteed by the lightweight design

| | |
|---------------------------------|---|
| uvex super fit CR | |
| Art. no. | 9178500 |
| Design | uvex supravision clean autoclavable (15 cycles) |
| Standard | EN 166, EN 170 |
| Frame | white, light blue W 166 FT CE |
| Lens | PC clear UV400 2C-1.2 W1 FTKN CE |
| Weight | 21 g |
| Order quantity multiples | 5 PC |

uvex super f OTG CR

- overspecs for wearers of prescription lenses with arm-hinge concept
- unrestricted peripheral vision
- soft arm ends for added comfort

| | |
|---------------------------------|---|
| uvex super f OTG CR | |
| Art. no. | 9169500 |
| Design | uvex supravision clean autoclavable (15 cycles) |
| Standard | EN 166, EN 170 |
| Frame | white, light blue W 166 FT CE |
| Lens | PC clear UV400 2C-1.2 W1 FTKN CE |
| Weight | 39 g |
| Order quantity multiples | 5 PC |

uvex ultrasonic CR

- goggles in sporty design, also suitable as overspecs
- lenses can be changed
- high mechanical strength (B: 120 m/s)
- wide panoramic field of vision
- no pressure problems with long-term wear thanks to the combination of hard and soft components
- with silicone headband

| | |
|---------------------------------|---|
| uvex ultrasonic CR | |
| Art. no. | 9302500 |
| Replacement lens | 9302259 |
| Design | uvex supravision clean autoclavable (20 cycles) |
| Standard | EN 166, EN 170 |
| Frame | transparent, white W 166 34 B CE |
| Lens | PC clear, UV400 2C-1.2 W1 BKN CE |
| Weight | 95 g |
| Order quantity multiples | 4 PC |

MADE IN GERMANY 



Safety Goggles

uvex ultrasonic



9302245



9302285



9302281



9302275



9302601



9302600



9302500



9302247



9302286



uvex ultrasonic

- goggles in sporty design, can also be worn over prescription spectacles
- high mechanical strength (B: 120 m/s)
- wide panoramic field of vision
- hard and soft components create soft, pressure free seal for comfortable all day wear

Areas of application:

- uvex supravision clean: sterile working environments (laboratories, hospitals, cleanrooms, food production)

| uvex ultrasonic | | | | | |
|--------------------------|-----------------------------|-----------------------------|--|--------------------------|---|
| Art. no. | 9302245 | 9302285 | 9302281 | 9302275 | 9302601 |
| Replacement lens | 9302255 | 9302255 | 9302255 | - | - |
| Version | uvex supravision excellence | uvex supravision excellence | uvex supravision excellence with neoprene headband | uvex supravision extreme | uvex supravision excellence reduced ventilation |
| Standard | EN 166, EN 170 | EN 166, EN 170 | EN 166, EN 170 | EN 166, EN 170 | EN 166, EN 170 |
| Frame | grey, orange | black, grey | black, grey | anthracite, lime | black, red |
| | W 166 34 B CE | W 166 34 B CE | W 166 34 B CE | W 166 34 B CE | W 166 34 B CE |
| Lens | PC clear, UV400 | PC clear, UV400 | PC clear, UV400 | PC clear, UV400 | PC clear, UV400 |
| | 2C-1.2 W1 BKN CE | 2C-1.2 W1 BKN CE | 2C-1.2 W1 BKN CE | 2C-1.2 W1 BKN CE | 2C-1.2 W1 BKN CE |
| Weight | 83 g | 83 g | 85g | 83 g | 95 g |
| Order quantity multiples | 4 PC | 4 PC | 4 PC | 4 PC | 4 PC |

| | | | | |
|--------------------------|--|---|---|---|
| Art. no. | 9302600 | 9302500 | 9302247 | 9302286 |
| Replacement lens | - | 9302259 | 9302257 | 9302256 |
| Version | uvex supravision extreme reduced ventilation | uvex supravision clean autoclavable (20 cycles) | uvex supravision excellence sunglare filter | uvex supravision excellence sunglare filter |
| Standard | EN 166, EN 170 | EN 166, EN 170 | EN 166, EN 172 | EN 166, EN 172 |
| Frame | blue, grey | transparent, white | grey, orange | black, grey |
| | W 166 34 B CE | W 166 34 B CE | W 166 34 B CE | W 166 34 B CE |
| Lens | PC clear, UV400 | PC clear, UV400 | PC brown, UV400 | PC grey, UV400 |
| | 2C-1.2 W1 BKN CE | 2C-1.2 W1 BKN CE | 5-2.5 W1 BKN CE | 5-2.5 W1 BKN CE |
| Weight | 95 g | 95 g | 83 g | 83 g |
| Order quantity multiples | 4 PC | 4 PC | 4 PC | 4 PC |

Safety Goggles

uvex ultravision CA



9301714



9301906



9301716



9301424

Please note:
CA lenses do not fit the PC models
and vice-versa.

uvex ultravision

- classic goggles with unrestricted field of vision
- can be worn over prescription spectacles
- available with polycarbonate or cellulose acetate lenses
- lenses can be changed
- polycarbonate lens with high mechanical strength (B: 120 m/s, T) in extreme temperatures
- mechanical strength of the cellulose acetate lens (F: 45 m/s)
- innovative indirect ventilation system helps maintain a comfortable climate around the eyes

| uvex ultravision | | | | |
|---------------------------------|------------------|--|------------------|------------------------|
| Art. no. | 9301714 | 9301906 | 9301716 | 9301424 |
| Replacement lens | 9300517 | 9300956 | 9300517 | 9300517 |
| Version | anti-fog | anti-fog | anti-fog | anti-fog |
| | | wide nose piece, particularly well suited in combination with dust masks | with foam layer | with neoprene headband |
| Standard | EN 166, EN 170 | EN 166, EN 170 | EN 166, EN 170 | EN 166, EN 170 |
| Frame | transparent grey | transparent grey | transparent grey | transparent grey |
| | W 166 34 F CE | W 166 3 F CE | W 166 34 F CE | W 166 34 F CE |
| Lens | CA clear | CA clear | CA clear | CA clear |
| | UV 380 | UV 380 | UV 380 | UV 380 |
| | 2-1.2 W1 FN CE | 2-1.2 W1 FN CE | 2-1.2 W1 FN CE | 2-1.2 W1 FN CE |
| Weight | 116 g | 130 g | 118 g | 119 g |
| Order quantity multiples | 4 PC | 4 PC | 4 PC | 4 PC |



Safety Goggles

uvex ultravision



9301605



9301116



9301105



9301626



9301813



9301815



9301613



9301633

| uvex ultravision | | | | | |
|--------------------------|------------------------------------|---------------------------------------|------------------------------------|---|---|
| Art. no. | 9301605 | 9301116 | 9301105 | 9301626 | 9301813 |
| Replacement lens | - | - | 9301255 | 9301255 | 9301255 |
| Tear-off films | - | - | - | - | 9300316 |
| Version | uvex supravision plus | uvex supravision plus with foam layer | uvex supravision excellence | uvex supravision excellence with foam layer | uvex supravision excellence with tear-off films, 2 units replacement films: 9300316 |
| Standard | EN 166, EN 170 | EN 166, EN 170 | EN 166, EN 170 | EN 166, EN 170 | EN 166, EN 170 |
| Frame | transparent grey W 166 34 BT CE | transparent grey W 166 34 BT CE | transparent grey W 166 34 BT CE | transparent grey W 166 34 BT CE | transparent grey W 166 34 BT CE |
| Lens | PC clear UV400 | PC clear UV400 | PC clear UV400 | PC clear UV400 | PC clear UV400 |
| Weight | 2C-1.2 W1 BTKN CE 131 g | 2C-1.2 W1 BTKN CE 134 g | 2C-1.2 W1 BTKN CE 131 g | 2C-1.2 W1 BTKN CE 134 g | 2C-1.2 W1 BTKN CE 126 g |
| Order quantity multiples | 4 PC | 4 PC | 4 PC | 4 PC | 4 PC |

| | | | |
|--------------------------|--|--|--|
| Art. no. | 9301815 | 9301613 | 9301633 |
| Replacement lens | 9301255 | 9301255 | - |
| Tear-off films | - | - | - |
| Version | uvex supravision excellence top ventilation closed | uvex supravision excellence closed ventilation (gas-proof) | uvex supravision excellence closed ventilation (gas-proof) heat-resistant frame material |
| Standard | EN 166, EN 170 | EN 166, EN 170 | EN 166, EN 170 |
| Frame | transparent grey W 166 34 BT CE | yellow W 166 345 BT CE | red W 166 345 BT CE |
| Lens | PC clear UV400 | PC clear UV400 | PC clear UV400 |
| Weight | 2C-1.2 W1 BTKN CE 131 g | 2C-1.2 W1 BTKN CE 133 g | 2C-1.2 W1 BTKN CE 133 g |
| Order quantity multiples | 4 PC | 4 PC | 4 PC |

Safety Goggles

uvex ultravision faceguard · helmet mounted safety goggles



9301555
Safety Goggle: 9301105



9301317



9301318

uvex ultravision faceguard

- combines goggles with face guard
- completely seals the eyes and protects the face
- 9301555 and 9301318: Lifts via a hinge mechanism, aiding communication, drinking, etc.

| | Goggles with face protection | Face protection | Face protection |
|----------------------------------|---|--|--|
| Art. no. | 9301555 | 9301317 | 9301318 |
| Version | Goggles with uvex supravision excellence (9301105) with faceguard (9301318) | for all models 9301 with PC lens without spectacles uncoated | for all models 9301 with PC lens without spectacles uncoated |
| Standard | EN 166, EN 170 | - | - |
| Frame | transparent grey W 166 34 BT CE | transparent CE | transparent CE |
| Lens | PC clear UV400 2C-1.2 W1 BTKN CE | - | - |
| Weight | 212 g | 64 g | 81 g |
| Order quantity multiples/ | 4 PC | PC | PC |
| Order unit | | | |



9302510



9301544



9924010

Helmet mounted safety goggles uvex ultrasonic and uvex ultravision

- safety goggles for combining with helmet and ear defenders uvex K1H and uvex K2H (ear defenders are not included)
- for attaching the uvex ultrasonic or uvex ultravision without ear defenders, additional adapters (9924010) are required!

| | uvex ultrasonic | uvex ultravision | Adapter |
|---------------------------------|--|--------------------------------|--|
| Art. no. | 9302510 | 9301544 | 9924010 |
| Version | uvex supravision extreme reduced ventilation | anti-fog inside | Adapter for attaching without earmuffs |
| Standard | EN 166, EN 170 | EN 166, EN 170 | |
| Frame | blue, grey W 166 34 B CE | transparent grey W 166 34 F CE | |
| Lens | PC clear UV400 2C-1.2 W1 BKN CE | CA clear UV 380 2-1.2 W1 FN CE | |
| Weight | 121 g | 132 g | - |
| Order quantity multiples | 4 PC | 4 PC | 4 PC |
| Content | - | - | 1 pair |



Safety Goggles

uvex carbonvision · uvex 9305 · uvex 9405



9307375



9307276



9307365

uvex carbonvision

- low profile wraparound style goggle
- lightweight at just 46 g
- highly compatible with other PPE
- close fitting frame and high mechanical strength (B: 120 m/s)

| uvex carbonvision | | | |
|---------------------------------|--------------------------|---|--|
| Art. no. | 9307375 | 9307365 | 9307276 |
| Version | uvex supravision extreme | uvex supravision extreme with neoprene headband | uvex supravision extreme sunglare filter |
| Standard | EN 166, EN 170 | EN 166, EN 170 | EN 166, EN 172 |
| Frame | black, grey | black, grey | black, grey |
| | W 166 34 B CE | W 166 34 B CE | W 166 34 B CE |
| Lens | PC clear | PC clear | PC grey |
| | UV400 | UV400 | UV400 |
| | 2C-1.2 W1 BKN CE | 2C-1.2 W1 BKN CE | 5-2.5 W1 BTKN CE |
| Weight | 46 g | 51 g | 46 g |
| Order quantity multiples | 5 PC | 5 PC | 5 PC |



9305714



9305514



9405714

uvex 9305

- classic goggles with cellulose acetate lens and ventilation system
- mechanical strength F: 45 m/s

| uvex 9305 | | |
|---------------------------------|--------------------------------------|---------------------------------------|
| Art. no. | 9305514 | 9305714 |
| Version | anti-fog inside with rubber headband | anti-fog inside with textile headband |
| Standard | EN 166, EN 170 | EN 166, EN 170 |
| Frame | transparent grey | transparent grey |
| | W 166 34 F CE | W 166 34 F CE |
| Lens | CA clear | CA clear |
| | UV 380 | UV 380 |
| | 2C-1.2 W1 FN CE | 2C-1.2 W1 FN CE |
| Weight | 95 g | 91 g |
| Order quantity multiples | 4 PC | 4 PC |

uvex 9405

- classic goggles with cellulose acetate lens and ventilation system
- mechanical strength F: 45 m/s

| uvex 9405 | |
|---------------------------------|------------------|
| Art. no. | 9405714 |
| Replacement lens | 9400517 |
| Version | anti-fog inside |
| Standard | EN 166, EN 170 |
| Frame | transparent grey |
| | W 166 34 F CE |
| Lens | CA clear |
| | UV 380 |
| | 2C-1.2 W1 FN CE |
| Weight | 84 g |
| Order quantity multiples | 4 PC |

Welding Protection

A new generation of welding protection eyewear available with different grey-tint lenses and protection classes. The innovative technology affords protection from UV and infrared light while maintaining perfect colour recognition in line with uvex sunglare filters.

The special uvex infradur plus coating has anti-fog properties which prevents the inside of the lenses misting up and the extreme scratch-resistance on the outside keeps damage from welding sparks to an absolute minimum.

With various welding safety spectacles and goggle solutions, there is something for everyone – enhancing comfort and the wearer experience.

N.B.: Do not use for electric welding.



All welding products have polycarbonate lenses providing protection against impact as well as UV rays, IR rays and visible glare.

The products do not provide protection against laser beams!

For expert advice on safety and in selecting the right laser protection eyewear, talk to our specialists

laservision

Call them on +49 (0)911 9736 8100.

uvex-laservision.com

New grey tint offers increased impact protection than traditional green welding tint products

IR/UV filter for improved safety

Sun/glare protection filters

Perfect colour recognition



Marking K and N for uvex infradur plus coated lenses

Levels of welding protection and recommendations for use according to EN 169

Autogenous welding/gas welding

| Level of protection | Use |
|---------------------|---|
| 1.7 | For welding assistants, protection against UV radiation and bright scattered light |
| 2 | Lightweight oxyacetylene cutting |
| 3 | Flame derusting, flame cutting, lightweight oxyacetylene cutting |
| 4 | Welding and hard soldering with up to 70 l/h of acetylene, flame cutting with up to 900 l/h of oxygen, steel and grey cast iron welding, lightweight oxyacetylene cutting |
| 5 | Welding and hard soldering with 70 to 200 l/h of acetylene, flame cutting with 2000 to 4000 l/h of oxygen |
| 6 | Welding and hard soldering with 200 to 800 l/h of acetylene, flame cutting with 2000 to 4000 l/h of oxygen |



Welding Protection

uvex i-vo · uvex super fit



9160041



9160043



9160045

uvex i-vo

- functional welding protection spectacles with adjustable side arms
- perfect colour recognition
- reliable protection provided by customised fit: multi-level side arm inclination and different side arm lengths allow the wearer to adjust the spectacles to suit their facial shape
- soft, uvex quattroflex arms and soft components around the nose and forehead for a comfortable, pressure-free fit
- the shape of the lenses offers unrestricted peripheral vision

| uvex i-vo | | | |
|---------------------------------|--|--|--|
| Art. no. | 9160041 | 9160043 | 9160045 |
| Version | uvex infradur plus welding protection level 1.7 | uvex infradur plus welding protection level 3 | uvex infradur plus welding protection level 5 |
| Standard | EN 166, EN 169 | EN 166, EN 169 | EN 166, EN 169 |
| Frame | black, green W 166 FT CE | black, green W 166 FT CE | black, green W 166 FT CE |
| Lens | PC grey UV400 + IR 1.7 W1 FTKN CE | PC grey UV400 + IR 3 W1 FTKN CE | PC grey UV400 + IR 5 W1 FTKN CE |
| Weight | 33 g | 33 g | 33 g |
| Order quantity multiples | 5 PC | 5 PC | 5 PC |



9178041



9178043

uvex super fit

- low weight welding safety spectacles with hinged side arms in a sporty design
- perfect colour recognition
- ultra thin, wraparound lens delivers maximum optical clarity and an excellent field of vision
- soft, adjustable nose piece
- low weight design (21 g) for increased wearer comfort

| uvex super fit | | |
|---------------------------------|--|--|
| Art. no. | 9178041 | 9178043 |
| Version | uvex infradur plus welding protection level 1.7 | uvex infradur plus welding protection level 3 |
| Standard | EN 166, EN 169 | EN 166, EN 169 |
| Frame | black, green W 166 FT CE | black, green W 166 FT CE |
| Lens | PC grey UV400 + IR 1.7 W1 FTKN CE | PC grey UV400 + IR 3 W1 FTKN CE |
| Weight | 21 g | 21 g |
| Order quantity multiples | 5 PC | 5 PC |

Welding Protection

uvex astrospec 2.0



9164141



9164143



9164146



9164145



9164144

uvex astrospec 2.0

- innovative development of the world's most popular uvex astrospec safety spectacles
- perfect colour recognition
- panoramic polycarbonate lens with integrated side shield for optimum protection of the whole eye
- fully adjustable side arms enable wearers to achieve a customised fit: multi-level side arm inclination and four different side arm lengths adjust to suit any facial shape
- uvex ventilation system with integrated brow guard for added comfort
- soft, adjustable nose piece and soft, non-slip ear pieces (uvex duo component technology) for pressure free fit
- fits easily into breast pocket thanks to flat-fold design

| uvex astrospec 2.0 | | | | | |
|---------------------------------|------------------------------|----------------------------|----------------------------|----------------------------|----------------------------|
| Art. no. | 9164141 | 9164143 | 9164144 | 9164145 | 9164146 |
| Version | uvex infradur plus | uvex infradur plus | uvex infradur plus | uvex infradur plus | uvex infradur plus |
| | welding protection level 1.7 | welding protection level 3 | welding protection level 4 | welding protection level 5 | welding protection level 6 |
| Standard | EN 166, EN 169 | EN 166, EN 169 | EN 166, EN 169 | EN 166, EN 169 | EN 166, EN 169 |
| Frame | black, green | black, green | black, green | black, green | black, green |
| | W 166 FT CE | W 166 FT CE | W 166 FT CE | W 166 FT CE | W 166 FT CE |
| Lens | PC grey | PC grey | PC grey | PC grey | PC grey |
| | UV400 + IR | UV400 + IR | UV400 + IR | UV400 + IR | UV400 + IR |
| | 1.7 W1 FTKN CE | 3 W1 FTKN CE | 4 W1 FTKN CE | 5 W1 FTKN CE | 6 W1 FTKN CE |
| Weight | 42 g | 42 g | 42 g | 42 g | 42 g |
| Order quantity multiples | 5 PC | 5 PC | 5 PC | 5 PC | 5 PC |

MADE IN GERMANY 



Welding Protection

uvex futura



uvex futura

- classic welding protection spectacles with outstanding coverage
- perfect colour recognition
- fully adjustable side arms enable wearers to achieve a customised fit: multi-level side arm inclination and four different side arm lengths adjust to suit any facial shape
- soft, duo-flex ear pieces for a pressure free fit

| uvex futura | | | | | |
|--------------------------|------------------------------|----------------------------|----------------------------|----------------------------|----------------------------|
| Art. no. | 9180141 | 9180143 | 9180144 | 9180145 | 9180146 |
| Version | uvex infradur | uvex infradur | uvex infradur | uvex infradur | uvex infradur |
| Standard | welding protection level 1.7 | welding protection level 3 | welding protection level 4 | welding protection level 5 | welding protection level 6 |
| Frame | EN 166, EN 169 | EN 166, EN 169 | EN 166, EN 169 | EN 166, EN 169 | EN 166, EN 169 |
| Lens | black, green | black, green | black, green | black, green | black, green |
| Weight | W 166 F CE | W 166 F CE | W 166 F CE | W 166 F CE | W 166 F CE |
| Order quantity multiples | PC grey | PC grey | PC grey | PC grey | PC grey |
| | UV400 + IR | UV400 + IR | UV400 + IR | UV400 + IR | UV400 + IR |
| | 1.7 W1 FTK CE | 3 W1 FTK CE | 4 W1 FTK CE | 5 W1 FTK CE | 6 W1 FTK CE |
| | 49 g | 49 g | 49 g | 49 g | 49 g |
| | 5 PC | 5 PC | 5 PC | 5 PC | 5 PC |

Welding Protection

uvex 9116



9116041



9116043



9116045



9116044



9116046

uvex 9116

- compact welding safety spectacles with a close fit and anatomically shaped nose bridge
- side shields and integrated brow guard design for increased protection
- perfect colour recognition
- specially-shaped frames provide protection against particles from below
- fully adjustable side arms enable wearers to achieve a customised fit: multi-level side arm inclination and four different side arm lengths adjust to suit any facial shape
- adjustable, soft and comfortable ear pieces

| uvex 9116 | | | | | |
|---------------------------------|------------------------------|----------------------------|----------------------------|----------------------------|----------------------------|
| Art. no. | 9116041 | 9116043 | 9116044 | 9116045 | 9116046 |
| Version | uvex infradur | uvex infradur | uvex infradur | uvex infradur | uvex infradur |
| | welding protection level 1.7 | welding protection level 3 | welding protection level 4 | welding protection level 5 | welding protection level 6 |
| Standard | EN 166, EN 169 | EN 166, EN 169 | EN 166, EN 169 | EN 166, EN 169 | EN 166, EN 169 |
| Frame | black, green | black, green | black, green | black, green | black, green |
| | W 166 S CE | W 166 S CE | W 166 S CE | W 166 S CE | W 166 S CE |
| Lens | PC grey | PC grey | PC grey | PC grey | PC grey |
| | UV400 + IR | UV400 + IR | UV400 + IR | UV400 + IR | UV400 + IR |
| | 1.7 W1 FTK CE | 3 W1 FTK CE | 4 W1 FTK CE | 5 W1 FTK CE | 6 W1 FTK CE |
| Weight | 27 g | 27 g | 27 g | 27 g | 27 g |
| Order quantity multiples | 5 PC | 5 PC | 5 PC | 5 PC | 5 PC |



Welding Protection

uvex 9104



9104041



9104043



9104044



9104045



9104046

uvex 9104

- compact welding safety spectacles with a close fit and anatomically shaped nose bridge
- side shields and integrated brow guard design for increased protection
- with flip-up and easily replaceable filter
- perfect colour recognition
- specially-shaped frames provide protection against particles from below
- fully adjustable side arms enable wearers to achieve a customised fit: multi-level side arm inclination and four different side arm lengths adjust to suit any facial shape
- adjustable, soft and comfortable ear pieces

| uvex 9104 | | | | | |
|---------------------------------|--|--|--|--|--|
| Art. no. | 9104041 | 9104043 | 9104044 | 9104045 | 9104046 |
| Flip-up replacement part | 9104081 | 9104083 | 9104084 | 9104085 | 9104086 |
| Version | uvex supravision plus with flip-up and easily replaceable filter | uvex supravision plus with flip-up and easily replaceable filter | uvex supravision plus with flip-up and easily replaceable filter | uvex supravision plus with flip-up and easily replaceable filter | uvex supravision plus with flip-up and easily replaceable filter |
| Standard | EN 166, EN 169, EN 170 | EN 166, EN 169, EN 170 | EN 166, EN 169, EN 170 | EN 166, EN 169, EN 170 | EN 166, EN 169, EN 170 |
| Frame | black, green W 166 S CE | black, green W 166 S CE | black, green W 166 S CE | black, green W 166 S CE | black, green W 166 S CE |
| Lens | PC clear UV400 | PC clear UV400 | PC clear UV400 | PC clear UV400 | PC clear UV400 |
| Additional lens | 2-1.2 W1 FKN CE PC grey, UV400 + IR uvex infradur, 1.7 W1 FTK CE welding protection level 1.7 | 2-1.2 W1 FKN CE PC grey, UV400 + IR uvex infradur, 3 W1 FTK CE welding protection level 3 | 2-1.2 W1 FKN CE PC grey, UV400 + IR uvex infradur, 4 W1 FTK CE welding protection level 4 | 2-1.2 W1 FKN CE PC grey, UV400 + IR uvex infradur, 5 W1 FTK CE welding protection level 5 | 2-1.2 W1 FKN CE PC grey, UV400 + IR uvex infradur, 6 W1 FTK CE welding protection level 6 |
| Weight | 42 g | 42 g | 42 g | 42 g | 42 g |
| Order quantity multiples | 5 PC | 5 PC | 5 PC | 5 PC | 5 PC |

MADE IN GERMANY

Welding Protection

uvex 9161 · uvex super f OTG



uvex 9161

- welding overspecs for wearers of prescription glasses
- perfect colour recognition
- fully adjustable side arms enable wearers to achieve a customised fit:
 - multi-level side arm inclination and four different side arm lengths adjust to suit any facial shape
- unrestricted peripheral vision
- pressure-free fit with soft uvex duoflex arms

| uvex 9161 | | | | | |
|---------------------------------|------------------------------|----------------------------|----------------------------|----------------------------|----------------------------|
| Art. no. | 9161141 | 9161143 | 9161144 | 9161145 | 9161146 |
| Version | uvex infradur | uvex infradur | uvex infradur | uvex infradur | uvex infradur |
| | welding protection level 1.7 | welding protection level 3 | welding protection level 4 | welding protection level 5 | welding protection level 6 |
| Standard | EN 166, EN 169 | EN 166, EN 169 | EN 166, EN 169 | EN 166, EN 169 | EN 166, EN 169 |
| Frame | black, green | black, green | black, green | black, green | black, green |
| | W 166 F CE | W 166 F CE | W 166 F CE | W 166 F CE | W 166 F CE |
| Lens | PC grey | PC grey | PC grey | PC grey | PC grey |
| | UV400 + IR | UV400 + IR | UV400 + IR | UV400 + IR | UV400 + IR |
| | 1.7 W1 FT CE | 3 W1 FT CE | 4 W1 FT CE | 5 W1 FT CE | 6 W1 FT CE |
| Weight | 46 g | 46 g | 46 g | 46 g | 46 g |
| Order quantity multiples | 5 PC | 5 PC | 5 PC | 5 PC | 5 PC |



uvex super f OTG

- welding overspecs with arm-hinge concept for wearers of prescription glasses
- perfect colour recognition
- unrestricted peripheral vision
- soft arm ends for increased comfort

| uvex super f OTG | | | |
|---------------------------------|------------------------------|----------------------------|----------------------------|
| Art. no. | 9169541 | 9169543 | 9169545 |
| Version | uvex infradur plus | uvex infradur plus | uvex infradur plus |
| | welding protection level 1.7 | welding protection level 3 | welding protection level 5 |
| Standard | EN 166, EN 169 | EN 166, EN 169 | EN 166, EN 169 |
| Frame | black, green | black, green | black, green |
| | W 166 FT CE | W 166 FT CE | W 166 FT CE |
| Lens | PC grey | PC grey | PC grey |
| | UV400 + IR | UV400 + IR | UV400 + IR |
| | 1.7 W1 FTKN CE | 3 W1 FTKN CE | 5 W1 FTKN CE |
| Weight | 39 g | 39 g | 39 g |
| Order quantity multiples | 5 PC | 5 PC | 5 PC |

MADE IN GERMANY

Welding Protection

uvex ultrasonic flip-up · uvex ultravision



9302043



9302045



uvex ultrasonic flip-up

- welding goggles in sporty design, can also be worn over prescription spectacles
- lenses can be changed
- perfect colour recognition
- with flip-up and easily replaceable filter
- high mechanical strength (B: 120 m/s)
- wide panoramic field of vision
- a combination of hard and soft components create soft, effect, pressure free seal for comfortable all day wear

| uvex ultrasonic | | |
|---------------------------------|---|---|
| Art. no. | 9302043 | 9302045 |
| Replacement lens flip-up | 9302083 | 9302085 |
| Version | uvex supravision excellence with flip-up and easily replaceable filter | uvex supravision excellence with flip-up and easily replaceable filter |
| Standard | EN 166, EN 169, EN 170 | EN 166, EN 169, EN 170 |
| Frame | black, green W 166 34 B CE | black, green W 166 34 B CE |
| Lens | PC clear, UV400 2-1.2 W1 BKN CE | PC clear, UV400 2-1.2 W1 BKN CE |
| Additional lens | PC grey, UV400 + IR uvex infradur 3 W1 CE welding protection level 3 | PC grey, UV400 + IR uvex infradur 5 W1 FTK CE welding protection level 5 |
| Weight | 123 g | 123 g |
| Order quantity multiples | 4 PC | 4 PC |



9301145

uvex ultravision

- classic style welding goggle with unrestricted field of vision
- can be worn over prescription spectacles
- perfect colour recognition
- outstanding wearability thanks to the indirect ventilation system

| uvex ultravision | |
|---------------------------------|--|
| Art. no. | 9301145 |
| Version | uvex infradur plus welding protection level 5 |
| Standard | EN 166, EN 169 |
| Frame | black W 166 3 BT CE |
| Lens | PC grey UV400 + IR 5 W1 BTKN CE |
| Weight | 131 g |
| Order quantity multiples | 4 PC |

Accessories

uvex cleaning accessories



9970005



9972101



9963000

uvex spectacle cleaning station

- including
- 2 x 9971000
- 1 x 9972103
- 1 x 9973101

| | |
|---------------------------------|---------|
| uvex spectacle cleaning station | |
| Art. no. | 9970005 |
| Order unit | PC |

| | |
|-------------------|---------|
| Plastic pump | |
| Art. no. | 9973101 |
| Order unit | PC |

Plastic pump

- for uvex cleaning fluid 9972103

uvex cleaning fluid

- 0.5 l cleaning fluid
- suitable for all viewing lenses

| | |
|---------------------|---------|
| uvex cleaning fluid | |
| Art. no. | 9972103 |
| Content | 500 ml |
| Order unit | PC |

Cleaning papers

- replacement silicone-free paper
- approx. 700 sheets
- antistatic
- suitable for all uvex lenses

| | |
|-------------------|---------|
| Cleaning papers | |
| Art. no. | 9971000 |
| Order unit | PC |

Magnetic wall bracket

- for easy mounting of the uvex cleaning station (9970005)

| | |
|-----------------------|---------|
| Magnetic wall bracket | |
| Art. no. | 9963004 |
| Order unit | PC |

uvex cleaning fluid

- Note:
- does not fit in the uvex spectacle cleaning station (9970005 and 9970002)

| | |
|---------------------|---------|
| uvex cleaning fluid | |
| Art. no. | 9972101 |
| Content | 500 ml |
| Order unit | PC |

- Note:
- spare parts for 9970002

| | |
|---------------------|---------|
| uvex cleaning fluid | |
| Art. no. | 9972100 |
| Content | 500 ml |
| Order unit | PC |

| | |
|-------------------|---------|
| Plastic pump | |
| Art. no. | 9973100 |
| Order unit | PC |

Spare parts for uvex cleaning station 9970002 only

uvex lens cleaning towelettes

- 100 towelettes per box
- silicone-free
- not antistatic
- individually sealed
- for all uvex lenses

| | |
|--------------------------|---------|
| uvex cleaning towelettes | |
| Art. no. | 9963000 |
| Order unit | PC |

- wall mount for individually sealed lens cleaning wipes
- assembly accessories included

| | |
|-------------------|---------|
| Wall mount | |
| Art. no. | 9963001 |
| Order unit | PC |



9972103



9971000



9973101



9963004



9963001

Accessories

uvex display · uvex microfibre cloth · uvex SECU Box



9957503

uvex display

- with integrated mirror
- for four safety spectacles and one pair of wide-vision goggles

| | |
|--------------|---------|
| uvex Display | |
| Art. no. | 9957503 |
| Order unit | PC |



9972130

uvex microfibre cloth

- for cleaning spectacle and goggle lenses

| | |
|-----------------------|---------|
| uvex microfibre cloth | |
| Art. no. | 9972130 |
| Order unit | BG |
| Content | 5 PC |



9957502

uvex SECU box

- storage box for wall assembly
- for spectacles and goggles:
 - 2 goggles or
 - 3 spectacles or
 - 1 goggles and 2 spectacles

| | |
|---------------|---------|
| uvex SECU box | |
| Art. no. | 9957502 |
| Order unit | PC |

Accessories

uvex safety eyewear cases



9954600

uvex eyewear case

- hard shell case in modern design
- extremely robust design to protect against external damage
- soft interior
- belt loop for ease of carrying
- practical snap hook
- specially for curved spectacles (e.g. uvex i-vo)

| | |
|---------------------------------|---------|
| uvex eyewear case | |
| Art. no. | 9954600 |
| Order quantity multiples | 5 PC |



9954500

uvex eyewear case

- extremely robust case
- reinforced zip for extra strength
- belt loop
- extra space for replacement lens
- suitable for all uvex spectacles

| | |
|---------------------------------|---------|
| uvex eyewear case | |
| Art. no. | 9954500 |
| Order quantity multiples | 5 PC |



9954501

uvex eyewear case

- goggle case with zip and belt loop
- large and very robust
- extra space for replacement lens
- suitable for spectacles and goggles

| | |
|---------------------------------|---------|
| uvex eyewear case | |
| Art. no. | 9954501 |
| Order quantity multiples | 5 PC |



Accessories

uvex safety eyewear cases · uvex carry case



6118002



9954650



9954355



9954360



9954326

uvex eyewear case

- flexible case made from robust nylon material
- extendable zip on side to increase space
- individually adjustable hook-and-loop fastener
- comes with belt loop
- suitable for all spectacles

| | |
|--------------------------|---------|
| uvex eyewear case | |
| Art. no. | 6118002 |
| Order quantity multiples | 1 PC |

uvex eyewear case

- flexible case made from robust nylon material
- individually adjustable hook-and-loop fastener
- comes with belt loop
- for goggle models

| | |
|--------------------------|---------|
| uvex eyewear case | |
| Art. no. | 9954650 |
| Order quantity multiples | 5 PC |

uvex microfibre case

- elegant microfibre case
- for uvex spectacles models

| | |
|--------------------------|---------|
| uvex microfibre case | |
| Art. no. | 9954355 |
| Order quantity multiples | 5 PC |

- elegant microfibre case
- for uvex goggles and overspecs

| | |
|--------------------------|---------|
| uvex microfibre case | |
| Art. no. | 9954360 |
| Order quantity multiples | 5 PC |

uvex carry case

- with adjustable storage compartments (Velcro)
- also suitable for goggles
- Spectacles capacity: 12 units (3 x 4)

- colour: black
- with length-adjustable shoulder strap

| | |
|-----------------|---------|
| uvex carry case | |
| Art. no. | 9954326 |
| Order unit | 1 PC |

Accessories

uvex hang-cords · uvex headband



9958017



9958003

uvex eyewear cord

- suitable for all uvex safety spectacles (except for the duoflex side arms)
- adjustment toggle for individual length adjustment

| | |
|--------------------------|---------|
| uvex eyewear cord | |
| Art. no. | 9958017 |
| Order quantity multiples | 5 PC |

uvex headband

- fully adjustable
- metal-free

| | |
|--------------------------|---------|
| uvex headband | |
| Art. no. | 9958003 |
| Order quantity multiples | 5 PC |



9958020



9958009

uvex pheos headband

- for attaching to uvex pheos standard and uvex pheos small
- metal-free
- individual length adjustment

| | |
|--------------------------|---------|
| uvex pheos headband | |
| Art. no. | 9958020 |
| Order quantity multiples | 5 PC |

uvex i-3 eyewear cord

- eyewear cord for uvex i-3 and uvex i-3 s

| | |
|--------------------------|---------|
| uvex i-3 eyewear cord | |
| Art. no. | 9958009 |
| Order quantity multiples | 5 PC |

see page 34, 35

see page 31, 32

Accessories

uvex hang-cords · uvex headband

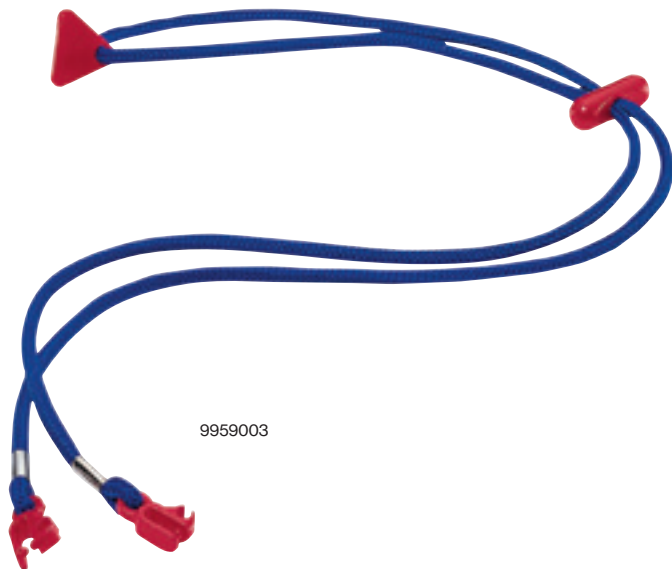

9959003

uvex eyewear cord

- individual length adjustment

| |
|--------------------------------------|
| uvex eyewear cord |
| Art. no. 9959003 |
| Order quantity multiples 5 PC |



9959004

uvex eyewear cord

- metal-free
- individual length adjustment

| |
|--------------------------------------|
| uvex eyewear cord |
| Art. no. 9959004 |
| Order quantity multiples 5 PC |



9959002

uvex eyewear cord

- suitable for all uvex spectacles

| |
|---------------------------------------|
| uvex eyewear cord |
| Art. no. 9959002 |
| Order quantity multiples 10 PC |



9958023















uvex x-fit headband

- for attaching to uvex x-fit and uvex x-fit pro
- individual length adjustment
- metal-free

| |
|--------------------------------------|
| uvex x-fit headband |
| Art. no. 9958023 |
| Order quantity multiples 5 PC |

see page 25

Cord/case matrix

| Model | Name | Cords/straps | | | | | | | | Cases | | | | | | |
|-------|----------------------|--|--|---|--|--|--|--|--|---|--|--|--|--|--|--|
| | |  9958017 |  9958003 |  9958020 (pheos) |  9958009 |  9959003 |  9959004 |  9959002 |  9958023 (x-fit family) |  9954600 |  9954500 |  9954501 |  6118002 |  9954650 |  9954355 |  9954360 |
| 9104 | uvex 9104 | <input type="checkbox"/> | <input checked="" type="checkbox"/> | <input type="checkbox"/> | <input type="checkbox"/> | <input checked="" type="checkbox"/> | <input checked="" type="checkbox"/> | <input checked="" type="checkbox"/> | <input type="checkbox"/> | <input checked="" type="checkbox"/> | <input checked="" type="checkbox"/> | <input checked="" type="checkbox"/> | <input checked="" type="checkbox"/> | <input checked="" type="checkbox"/> | <input checked="" type="checkbox"/> | <input checked="" type="checkbox"/> |
| 9116 | uvex 9116 | <input type="checkbox"/> | <input checked="" type="checkbox"/> | <input type="checkbox"/> | <input type="checkbox"/> | <input checked="" type="checkbox"/> | <input checked="" type="checkbox"/> | <input checked="" type="checkbox"/> | <input type="checkbox"/> | <input checked="" type="checkbox"/> | <input checked="" type="checkbox"/> | <input checked="" type="checkbox"/> | <input checked="" type="checkbox"/> | <input checked="" type="checkbox"/> | <input checked="" type="checkbox"/> | <input checked="" type="checkbox"/> |
| 9134 | uvex meteor | <input type="checkbox"/> | <input checked="" type="checkbox"/> | <input type="checkbox"/> | <input type="checkbox"/> | <input checked="" type="checkbox"/> | <input checked="" type="checkbox"/> | <input checked="" type="checkbox"/> | <input type="checkbox"/> | <input checked="" type="checkbox"/> | <input checked="" type="checkbox"/> | <input checked="" type="checkbox"/> | <input checked="" type="checkbox"/> | <input checked="" type="checkbox"/> | <input checked="" type="checkbox"/> | <input checked="" type="checkbox"/> |
| 9137 | uvex ceramic | <input checked="" type="checkbox"/> | <input type="checkbox"/> | <input type="checkbox"/> | <input type="checkbox"/> | <input type="checkbox"/> | <input type="checkbox"/> | <input checked="" type="checkbox"/> | <input type="checkbox"/> | <input checked="" type="checkbox"/> | <input checked="" type="checkbox"/> | <input checked="" type="checkbox"/> | <input checked="" type="checkbox"/> | <input checked="" type="checkbox"/> | <input checked="" type="checkbox"/> | <input checked="" type="checkbox"/> |
| 9155 | uvex mercury | <input checked="" type="checkbox"/> | <input type="checkbox"/> | <input type="checkbox"/> | <input type="checkbox"/> | <input type="checkbox"/> | <input type="checkbox"/> | <input checked="" type="checkbox"/> | <input type="checkbox"/> | <input type="checkbox"/> | <input checked="" type="checkbox"/> | <input checked="" type="checkbox"/> | <input checked="" type="checkbox"/> | <input checked="" type="checkbox"/> | <input checked="" type="checkbox"/> | <input checked="" type="checkbox"/> |
| 9159 | uvex winner | <input checked="" type="checkbox"/> | <input type="checkbox"/> | <input type="checkbox"/> | <input type="checkbox"/> | <input type="checkbox"/> | <input type="checkbox"/> | <input checked="" type="checkbox"/> | <input type="checkbox"/> | <input checked="" type="checkbox"/> | <input checked="" type="checkbox"/> | <input checked="" type="checkbox"/> | <input checked="" type="checkbox"/> | <input checked="" type="checkbox"/> | <input checked="" type="checkbox"/> | <input checked="" type="checkbox"/> |
| 9160 | uvex i-vo | <input type="checkbox"/> | <input checked="" type="checkbox"/> | <input type="checkbox"/> | <input type="checkbox"/> | <input checked="" type="checkbox"/> | <input checked="" type="checkbox"/> | <input checked="" type="checkbox"/> | <input type="checkbox"/> | <input checked="" type="checkbox"/> | <input checked="" type="checkbox"/> | <input checked="" type="checkbox"/> | <input checked="" type="checkbox"/> | <input checked="" type="checkbox"/> | <input checked="" type="checkbox"/> | <input checked="" type="checkbox"/> |
| 9161 | uvex 9161 | <input type="checkbox"/> | <input type="checkbox"/> | <input type="checkbox"/> | <input type="checkbox"/> | <input type="checkbox"/> | <input type="checkbox"/> | <input checked="" type="checkbox"/> | <input type="checkbox"/> | <input checked="" type="checkbox"/> | <input checked="" type="checkbox"/> | <input checked="" type="checkbox"/> | <input checked="" type="checkbox"/> | <input checked="" type="checkbox"/> | <input checked="" type="checkbox"/> | <input checked="" type="checkbox"/> |
| 9164 | uvex astrospec 2.0 | <input checked="" type="checkbox"/> | <input checked="" type="checkbox"/> | <input type="checkbox"/> | <input type="checkbox"/> | <input checked="" type="checkbox"/> | <input checked="" type="checkbox"/> | <input checked="" type="checkbox"/> | <input type="checkbox"/> | <input checked="" type="checkbox"/> | <input checked="" type="checkbox"/> | <input checked="" type="checkbox"/> | <input checked="" type="checkbox"/> | <input checked="" type="checkbox"/> | <input checked="" type="checkbox"/> | <input checked="" type="checkbox"/> |
| 9169 | uvex super OTG | <input checked="" type="checkbox"/> | <input type="checkbox"/> | <input type="checkbox"/> | <input type="checkbox"/> | <input type="checkbox"/> | <input type="checkbox"/> | <input checked="" type="checkbox"/> | <input type="checkbox"/> | <input type="checkbox"/> | <input checked="" type="checkbox"/> | <input checked="" type="checkbox"/> | <input checked="" type="checkbox"/> | <input checked="" type="checkbox"/> | <input checked="" type="checkbox"/> | <input checked="" type="checkbox"/> |
| 9169 | uvex super f OTG | <input checked="" type="checkbox"/> | <input type="checkbox"/> | <input type="checkbox"/> | <input type="checkbox"/> | <input type="checkbox"/> | <input type="checkbox"/> | <input checked="" type="checkbox"/> | <input type="checkbox"/> | <input type="checkbox"/> | <input type="checkbox"/> | <input checked="" type="checkbox"/> | <input checked="" type="checkbox"/> | <input checked="" type="checkbox"/> | <input checked="" type="checkbox"/> | <input checked="" type="checkbox"/> |
| 9172 | uvex super g | <input checked="" type="checkbox"/> | <input type="checkbox"/> | <input type="checkbox"/> | <input type="checkbox"/> | <input type="checkbox"/> | <input type="checkbox"/> | <input checked="" type="checkbox"/> | <input type="checkbox"/> | <input checked="" type="checkbox"/> | <input checked="" type="checkbox"/> | <input checked="" type="checkbox"/> | <input checked="" type="checkbox"/> | <input checked="" type="checkbox"/> | <input checked="" type="checkbox"/> | <input checked="" type="checkbox"/> |
| 9175 | uvex skyguard NT | <input type="checkbox"/> | <input checked="" type="checkbox"/> | <input type="checkbox"/> | <input type="checkbox"/> | <input checked="" type="checkbox"/> | <input checked="" type="checkbox"/> | <input checked="" type="checkbox"/> | <input type="checkbox"/> | <input checked="" type="checkbox"/> | <input checked="" type="checkbox"/> | <input checked="" type="checkbox"/> | <input type="checkbox"/> | <input checked="" type="checkbox"/> | <input checked="" type="checkbox"/> | <input checked="" type="checkbox"/> |
| 9178 | uvex super fit | <input checked="" type="checkbox"/> | <input type="checkbox"/> | <input type="checkbox"/> | <input type="checkbox"/> | <input type="checkbox"/> | <input type="checkbox"/> | <input checked="" type="checkbox"/> | <input type="checkbox"/> | <input checked="" type="checkbox"/> | <input checked="" type="checkbox"/> | <input checked="" type="checkbox"/> | <input checked="" type="checkbox"/> | <input checked="" type="checkbox"/> | <input checked="" type="checkbox"/> | <input checked="" type="checkbox"/> |
| 9180 | uvex futura | <input type="checkbox"/> | <input type="checkbox"/> | <input type="checkbox"/> | <input type="checkbox"/> | <input type="checkbox"/> | <input type="checkbox"/> | <input checked="" type="checkbox"/> | <input type="checkbox"/> | <input checked="" type="checkbox"/> | <input checked="" type="checkbox"/> | <input checked="" type="checkbox"/> | <input checked="" type="checkbox"/> | <input checked="" type="checkbox"/> | <input checked="" type="checkbox"/> | <input checked="" type="checkbox"/> |
| 9183 | uvex i-5 | <input checked="" type="checkbox"/> | <input type="checkbox"/> | <input type="checkbox"/> | <input type="checkbox"/> | <input type="checkbox"/> | <input type="checkbox"/> | <input checked="" type="checkbox"/> | <input type="checkbox"/> | <input checked="" type="checkbox"/> | <input checked="" type="checkbox"/> | <input checked="" type="checkbox"/> | <input checked="" type="checkbox"/> | <input checked="" type="checkbox"/> | <input checked="" type="checkbox"/> | <input checked="" type="checkbox"/> |
| 9188 | uvex cybric | <input type="checkbox"/> | <input checked="" type="checkbox"/> | <input type="checkbox"/> | <input type="checkbox"/> | <input checked="" type="checkbox"/> | <input checked="" type="checkbox"/> | <input checked="" type="checkbox"/> | <input type="checkbox"/> | <input checked="" type="checkbox"/> | <input checked="" type="checkbox"/> | <input checked="" type="checkbox"/> | <input checked="" type="checkbox"/> | <input checked="" type="checkbox"/> | <input checked="" type="checkbox"/> | <input checked="" type="checkbox"/> |
| 9188 | uvex cyberguard | <input type="checkbox"/> | <input type="checkbox"/> | <input type="checkbox"/> | <input type="checkbox"/> | <input type="checkbox"/> | <input type="checkbox"/> | <input type="checkbox"/> | <input type="checkbox"/> | <input checked="" type="checkbox"/> | <input checked="" type="checkbox"/> | <input checked="" type="checkbox"/> | <input checked="" type="checkbox"/> | <input checked="" type="checkbox"/> | <input checked="" type="checkbox"/> | <input checked="" type="checkbox"/> |
| 9190 | uvex i-3 / i-3 s | <input checked="" type="checkbox"/> | <input type="checkbox"/> | <input type="checkbox"/> | <input checked="" type="checkbox"/> | <input type="checkbox"/> | <input type="checkbox"/> | <input checked="" type="checkbox"/> | <input type="checkbox"/> | <input checked="" type="checkbox"/> | <input checked="" type="checkbox"/> | <input checked="" type="checkbox"/> | <input checked="" type="checkbox"/> | <input checked="" type="checkbox"/> | <input checked="" type="checkbox"/> | <input checked="" type="checkbox"/> |
| 9192 | uvex pheos / pheos s | <input checked="" type="checkbox"/> | <input type="checkbox"/> | <input checked="" type="checkbox"/> | <input type="checkbox"/> | <input checked="" type="checkbox"/> | <input checked="" type="checkbox"/> | <input checked="" type="checkbox"/> | <input type="checkbox"/> | <input checked="" type="checkbox"/> | <input checked="" type="checkbox"/> | <input checked="" type="checkbox"/> | <input checked="" type="checkbox"/> | <input checked="" type="checkbox"/> | <input checked="" type="checkbox"/> | <input checked="" type="checkbox"/> |
| 9192 | uvex pheos guard / s | <input type="checkbox"/> | <input type="checkbox"/> | <input checked="" type="checkbox"/> | <input type="checkbox"/> | <input type="checkbox"/> | <input type="checkbox"/> | <input type="checkbox"/> | <input type="checkbox"/> | <input checked="" type="checkbox"/> | <input checked="" type="checkbox"/> | <input checked="" type="checkbox"/> | <input checked="" type="checkbox"/> | <input checked="" type="checkbox"/> | <input checked="" type="checkbox"/> | <input checked="" type="checkbox"/> |
| 9193 | uvex sportstyle | <input checked="" type="checkbox"/> | <input type="checkbox"/> | <input type="checkbox"/> | <input type="checkbox"/> | <input type="checkbox"/> | <input type="checkbox"/> | <input checked="" type="checkbox"/> | <input type="checkbox"/> | <input checked="" type="checkbox"/> | <input checked="" type="checkbox"/> | <input checked="" type="checkbox"/> | <input checked="" type="checkbox"/> | <input checked="" type="checkbox"/> | <input checked="" type="checkbox"/> | <input checked="" type="checkbox"/> |
| 9194 | uvex i-works | <input checked="" type="checkbox"/> | <input checked="" type="checkbox"/> | <input type="checkbox"/> | <input type="checkbox"/> | <input checked="" type="checkbox"/> | <input checked="" type="checkbox"/> | <input checked="" type="checkbox"/> | <input type="checkbox"/> | <input checked="" type="checkbox"/> | <input checked="" type="checkbox"/> | <input checked="" type="checkbox"/> | <input checked="" type="checkbox"/> | <input checked="" type="checkbox"/> | <input checked="" type="checkbox"/> | <input checked="" type="checkbox"/> |
| 9195 | uvex skyper | <input type="checkbox"/> | <input checked="" type="checkbox"/> | <input type="checkbox"/> | <input type="checkbox"/> | <input checked="" type="checkbox"/> | <input checked="" type="checkbox"/> | <input checked="" type="checkbox"/> | <input type="checkbox"/> | <input checked="" type="checkbox"/> | <input checked="" type="checkbox"/> | <input checked="" type="checkbox"/> | <input checked="" type="checkbox"/> | <input checked="" type="checkbox"/> | <input checked="" type="checkbox"/> | <input checked="" type="checkbox"/> |
| 9197 | uvex skyper sx2 | <input type="checkbox"/> | <input checked="" type="checkbox"/> | <input type="checkbox"/> | <input type="checkbox"/> | <input checked="" type="checkbox"/> | <input checked="" type="checkbox"/> | <input checked="" type="checkbox"/> | <input type="checkbox"/> | <input checked="" type="checkbox"/> | <input checked="" type="checkbox"/> | <input checked="" type="checkbox"/> | <input checked="" type="checkbox"/> | <input checked="" type="checkbox"/> | <input checked="" type="checkbox"/> | <input checked="" type="checkbox"/> |
| 9198 | uvex pheos cx2 | <input type="checkbox"/> | <input type="checkbox"/> | <input type="checkbox"/> | <input type="checkbox"/> | <input type="checkbox"/> | <input type="checkbox"/> | <input checked="" type="checkbox"/> | <input type="checkbox"/> | <input checked="" type="checkbox"/> | <input checked="" type="checkbox"/> | <input checked="" type="checkbox"/> | <input checked="" type="checkbox"/> | <input checked="" type="checkbox"/> | <input checked="" type="checkbox"/> | <input checked="" type="checkbox"/> |
| 9199 | uvex x-fit | <input checked="" type="checkbox"/> | <input type="checkbox"/> | <input type="checkbox"/> | <input type="checkbox"/> | <input type="checkbox"/> | <input checked="" type="checkbox"/> | <input checked="" type="checkbox"/> | <input checked="" type="checkbox"/> | <input checked="" type="checkbox"/> | <input checked="" type="checkbox"/> | <input checked="" type="checkbox"/> | <input checked="" type="checkbox"/> | <input checked="" type="checkbox"/> | <input checked="" type="checkbox"/> | <input checked="" type="checkbox"/> |
| 9199 | uvex x-fit pro | <input type="checkbox"/> | <input type="checkbox"/> | <input type="checkbox"/> | <input type="checkbox"/> | <input type="checkbox"/> | <input checked="" type="checkbox"/> | <input checked="" type="checkbox"/> | <input checked="" type="checkbox"/> | <input checked="" type="checkbox"/> | <input checked="" type="checkbox"/> | <input checked="" type="checkbox"/> | <input checked="" type="checkbox"/> | <input checked="" type="checkbox"/> | <input checked="" type="checkbox"/> | <input checked="" type="checkbox"/> |
| 9231 | uvex polavision | <input checked="" type="checkbox"/> | <input type="checkbox"/> | <input type="checkbox"/> | <input type="checkbox"/> | <input type="checkbox"/> | <input type="checkbox"/> | <input checked="" type="checkbox"/> | <input type="checkbox"/> | <input checked="" type="checkbox"/> | <input checked="" type="checkbox"/> | <input checked="" type="checkbox"/> | <input checked="" type="checkbox"/> | <input checked="" type="checkbox"/> | <input checked="" type="checkbox"/> | <input checked="" type="checkbox"/> |
| 9301 | uvex ultravision | <input type="checkbox"/> | <input type="checkbox"/> | <input type="checkbox"/> | <input type="checkbox"/> | <input type="checkbox"/> | <input type="checkbox"/> | <input type="checkbox"/> | <input type="checkbox"/> | <input type="checkbox"/> | <input checked="" type="checkbox"/> | <input type="checkbox"/> | <input checked="" type="checkbox"/> | <input type="checkbox"/> | <input checked="" type="checkbox"/> | <input checked="" type="checkbox"/> |
| 9302 | uvex ultrasonic | <input type="checkbox"/> | <input type="checkbox"/> | <input type="checkbox"/> | <input type="checkbox"/> | <input type="checkbox"/> | <input type="checkbox"/> | <input type="checkbox"/> | <input type="checkbox"/> | <input type="checkbox"/> | <input checked="" type="checkbox"/> | <input type="checkbox"/> | <input checked="" type="checkbox"/> | <input type="checkbox"/> | <input checked="" type="checkbox"/> | <input checked="" type="checkbox"/> |
| 9305 | uvex 9305 | <input type="checkbox"/> | <input type="checkbox"/> | <input type="checkbox"/> | <input type="checkbox"/> | <input type="checkbox"/> | <input type="checkbox"/> | <input type="checkbox"/> | <input type="checkbox"/> | <input type="checkbox"/> | <input checked="" type="checkbox"/> | <input type="checkbox"/> | <input checked="" type="checkbox"/> | <input type="checkbox"/> | <input checked="" type="checkbox"/> | <input checked="" type="checkbox"/> |
| 9307 | uvex carbonvision | <input type="checkbox"/> | <input type="checkbox"/> | <input type="checkbox"/> | <input type="checkbox"/> | <input type="checkbox"/> | <input type="checkbox"/> | <input type="checkbox"/> | <input checked="" type="checkbox"/> | <input checked="" type="checkbox"/> | <input checked="" type="checkbox"/> | <input checked="" type="checkbox"/> | <input checked="" type="checkbox"/> | <input checked="" type="checkbox"/> | <input checked="" type="checkbox"/> | <input checked="" type="checkbox"/> |
| 9308 | uvex u-sonic | <input type="checkbox"/> | <input type="checkbox"/> | <input type="checkbox"/> | <input type="checkbox"/> | <input type="checkbox"/> | <input type="checkbox"/> | <input type="checkbox"/> | <input type="checkbox"/> | <input type="checkbox"/> | <input checked="" type="checkbox"/> | <input type="checkbox"/> | <input checked="" type="checkbox"/> | <input type="checkbox"/> | <input checked="" type="checkbox"/> | <input checked="" type="checkbox"/> |
| 9309 | uvex pheos cx2 sonic | <input type="checkbox"/> | <input type="checkbox"/> | <input type="checkbox"/> | <input type="checkbox"/> | <input type="checkbox"/> | <input type="checkbox"/> | <input type="checkbox"/> | <input checked="" type="checkbox"/> | <input checked="" type="checkbox"/> | <input checked="" type="checkbox"/> | <input checked="" type="checkbox"/> | <input checked="" type="checkbox"/> | <input checked="" type="checkbox"/> | <input checked="" type="checkbox"/> | <input checked="" type="checkbox"/> |
| 9320 | uvex megasonic | <input type="checkbox"/> | <input type="checkbox"/> | <input type="checkbox"/> | <input type="checkbox"/> | <input type="checkbox"/> | <input type="checkbox"/> | <input type="checkbox"/> | <input type="checkbox"/> | <input type="checkbox"/> | <input checked="" type="checkbox"/> | <input type="checkbox"/> | <input checked="" type="checkbox"/> | <input type="checkbox"/> | <input checked="" type="checkbox"/> | <input checked="" type="checkbox"/> |
| 9405 | uvex 9405 | <input type="checkbox"/> | <input type="checkbox"/> | <input type="checkbox"/> | <input type="checkbox"/> | <input type="checkbox"/> | <input type="checkbox"/> | <input type="checkbox"/> | <input type="checkbox"/> | <input type="checkbox"/> | <input checked="" type="checkbox"/> | <input type="checkbox"/> | <input checked="" type="checkbox"/> | <input type="checkbox"/> | <input checked="" type="checkbox"/> | <input checked="" type="checkbox"/> |

2 goggles or 3-4 spectacles
or 1 goggles + 2 spectacles

compatible not compatible



Applications

Always the perfect solution

■ Mechanical risk
 ■ Chemical risk
 ■ Optical risk

| Working conditions | Eyewear model | Lens material | Lens tint | Lens coating |
|---|------------------------------------|---------------|--------------------------------|--|
| Light and precision engineering | Spectacles | PC | clear | uvex supravision AR (anti-reflet) uvex supravision excellence |
| Assembly, maintenance | Spectacles | PC | clear | uvex supravision excellence |
| Grinding, angle grinding | Spectacles Goggles | PC | clear | uvex supravision excellence uvex supravision extreme |
| Turning, milling | Spectacles | PC | clear | uvex supravision excellence |
| Dusty environments | Goggles | PC | clear | uvex supravision excellence uvex supravision extreme |
| Foundry cleaning | Goggles | PC | clear | uvex supravision excellence uvex supravision extreme |
| Forestry and agriculture | Spectacles | PC | clear amber grey 23% | uvex supravision excellence uvex supravision extreme |
| Laboratory | Spectacles Goggles | PC CA | clear | uvex supravision sapphire uvex supravision excellence |
| Working with acids and galvanic media | Goggles | PC CA | clear | uvex supravision excellence uvex supravision extreme |
| Spot welding, soldering oxygene cutting gas welding, braze welding Welders assistant foundries furnaces | Spectacles Goggles | PC | welding shade | uvex infradur uvex infradur plus |
| Outdoors – sunglare | Spectacles | PC | grey brown silver mirror | uvex supravision excellence uvex supravision extreme |
| Offshoring / maritime | Spectacles | PC | variomatic polavision | uvex supravision variomatic uvex polavision |
| Strong lighting, glare | Spectacles | PC | CBR 65 silver mirror 53% | uvex supravision excellence uvex supravision extreme |
| Mixed lighting | Spectacles | PC | clear | uvex supravision AR (anti-reflet) |
| Sterile working conditions | Spectacles Overspecs | PC | clear | uvex supravision CR |
| Oil and gas | Spectacles Overspecs Goggles | PC | clear | uvex supravision plus |
| Plant visitors | Spectacles Overspecs | PC | clear | uvex supravision excellence uvex supravision sapphire uncoated |

Safety Eyewear

Overview

| Model | Name | Product | Order quantity multiples/ Order unit | uvex supravision sapphire | supravision plus | uvex supravision excellence | uvex supravision extreme | uvex supravision ETC | uvex supravision clean | uvex supravision AR | Silver mirror, inside anti-fog | uvex supravision variomatic | uvex infradur | uvex infradur plus | CA uncoated | CA anti-fog on the inside | Scratch-resistant on both sides | Scratch-resistant + anti-fog | Uncoated | Page |
|-------|-------------------------------------|--|---|---------------------------|------------------|-----------------------------|--------------------------|----------------------|------------------------|---------------------|--------------------------------|-----------------------------|---------------|--------------------|-------------|---------------------------|---------------------------------|------------------------------|----------|-------|
| 9104 | uvex 9104 | Safety spectacles – welding protection | 5 PC | | ■ | | | | | | | | ■ | | | | | | | 63 |
| 9104 | uvex 9104 | Replacement lenses Flip-up | 5 PC | | | | | | | | | | ■ | | | | | | | 63 |
| 9116 | uvex 9116 | Safety spectacles – welding protection | 5 PC | | | | | | | | | | ■ | | | | | | | 62 |
| 9134 | uvex meteor | Plastic temple spectacles | 5 PC | ■ | | | | | | | | | | | | | | | ■ | 42 |
| 9137 | uvex ceramic | Metal temple spectacles | 5 PC | ■ | | | | | | | | | | | | | | | | 44 |
| 9155 | uvex mercury | Metal temple spectacles | 5 PC | ■ | | | | | | | | | | | | | | | | 44 |
| 9159 | uvex winner | Metal temple spectacles | 5 PC | | | | | | | | | | | | | | ■ | ■ | | 44 |
| 9160 | uvex i-vo | Plastic temple spectacles | 5 PC | ■ | ■ | ■ | | | | | | | | | | | | | | 40 |
| 9160 | uvex i-vo | Replacement lenses | 5 PC | ■ | | ■ | | | | | | | | | | | | | | 40 |
| 9160 | uvex i-vo | Safety spectacles – welding protection | 5 PC | | | | | | | | | | | ■ | | | | | | 59 |
| 9161 | uvex 9161 | Plastic temple spectacles | 5 PC | ■ | ■ | | | | | | | | | | | | | | ■ | 46 |
| 9161 | uvex 9161 | Safety spectacles – welding protection | 5 PC | | | | | | | | | | ■ | | | | | | | 64 |
| 9164 | uvex astrospec 2.0 | Plastic temple spectacles | 5 PC | ■ | ■ | ■ | ■ | | | | | | | | | | | | | 37 |
| 9164 | uvex astrospec 2.0 | Safety spectacles – welding protection | 5 PC | | | | | | | | | | | ■ | | | | | | 60 |
| 9169 | uvex super OTG | Plastic temple spectacles | 5 PC | ■ | | ■ | | | | | | | | | | | | | | 46 |
| 9169 | uvex super f OTG | Plastic temple spectacles | 5 PC | ■ | | ■ | | | | | | | | | | | | | | 47 |
| 9169 | uvex super f OTG | Plastic temple spectacles | PC | | | | | | | | | ■ | | | | | | | | 47 |
| 9169 | uvex super f OTG | Plastic temple spectacles UV 525 | 5 PC | ■ | | | | | | | | | | | | | | | | 47 |
| 9169 | uvex super f OTG CR | Plastic temple spectacles | 5 PC | | | | | | ■ | | | | | | | | | | | 52 |
| 9169 | uvex super f OTG | Safety spectacles – welding protection | 5 PC | | | | | | | | | | | ■ | | | | | | 64 |
| 9172 | uvex super g | Plastic temple spectacles | 5 PC | ■ | ■ | ■ | | | | | | | | | | | | | | 38 |
| 9172 | uvex super g | Replacement lenses | 5 PC | | | ■ | | | | | | | | | | | | | | 38/39 |
| 9175 | uvex skyguard NT | Plastic temple spectacles | 5 PC | | | ■ | ■ | | | | | | | | | | | | | 43 |
| 9178 | uvex super fit | Plastic temple spectacles | 5 PC | ■ | ■ | ■ | | | | | | | | | | | | | | 39 |
| 9178 | uvex super fit ETC | Plastic temple spectacles | 5 PC | | | | | ■ | | | | | | | | | | | | 39 |
| 9178 | uvex super fit CR | Plastic temple spectacles | 5 PC | | | | | | ■ | | | | | | | | | | | 39/52 |
| 9178 | uvex super fit | Safety spectacles – welding protection | 5 PC | | | | | | | | | | | ■ | | | | | | 59 |
| 9180 | uvex futura | Plastic temple spectacles | 5 PC | ■ | ■ | | | | | | | | | | | | | | | 42 |
| 9180 | uvex futura | Replacement lenses | 5 PAA | ■ | ■ | | | | | | | | | | | | | | | 42 |
| 9180 | uvex futura | Safety spectacles – welding protection | 5 PC | | | | | | | | | | ■ | | | | | | | 61 |
| 9183 | uvex i-5 | Plastic temple spectacles | 5 PC | | | ■ | | | | | | | | | | | | | | 23 |
| 9188 | uvex cybric | Plastic temple spectacles | 5 PC | ■ | ■ | | | | | | | | | | | | | | | 42 |
| 9188 | uvex cyberguard | Plastic temple spectacles | 5 PC | | ■ | | | | | | | | | | | | | | | 42 |
| 9190 | uvex i-3/uvex i-3s | Plastic temple spectacles | 5 PC | ■ | ■ | ■ | | | | ■ | ■ | | | | | | | | | 34/35 |
| 9190 | uvex i-3 | Plastic temple spectacles | PC | | | | | | | | | ■ | | | | | | | | 34 |
| 9190 | uvex i-3 | Replacement lenses | 5 PC | | | ■ | | | | | | | | | | | | | | 34 |
| 9192 | uvex pheos/uvex pheos s | Plastic temple spectacles | 5 PC | | ■ | ■ | ■ | | | | ■ | | | | | | | | | 31/32 |
| 9192 | uvex pheos guard/uvex pheos s guard | uvex pheos headband version | 4 PC | | | | ■ | | | | | | | | | | | | | 32 |
| 9192 | uvex pheos/uvex pheos s | Extra frame | 5 PC | | | | | | | | | | | | | | | | | 32 |
| 9193 | uvex sportstyle | Plastic temple spectacles | 5 PC | | ■ | ■ | ■ | | | ■ | ■ | | | | | | | | | 29 |
| 9193 | uvex sportstyle | Plastic temple spectacles | PC | | | | | | | | | ■ | | | | | | | | 29 |
| 9194 | uvex i-works | Plastic temple spectacles | 5 PC | | | ■ | | | | | ■ | | | | | | | | | 36 |
| 9195 | uvex skyper | Plastic temple spectacles | 5 PC | ■ | | ■ | | | | | | | | | | | | | | 41 |
| 9195 | uvex skyper | Replacement lenses | 5 PC | | | ■ | | | | | | | | | | | | | | 41 |
| 9197 | uvex skyper sx2 | Plastic temple spectacles | 5 PC | ■ | | ■ | | | | | | | | | | | | | | 41 |
| 9198 | uvex pheos cx2 | Plastic temple spectacles | 5 PC | ■ | | ■ | ■ | | | | | ■ | | | | | | | | 30 |
| 9199 | uvex x-fit | Plastic temple spectacles | 5 PC | ■ | | ■ | | | | | | | | | | | | | | 27 |



| Model | Name | Product | Order quantity multiples/ Order unit | uvex supravision sapphire | supravision plus | uvex supravision excellence | uvex supravision extreme | uvex supravision ETC | uvex supravision clean | uvex supravision AR | Silver mirror, inside anti-fog | uvex supravision variomatic | uvex infradur | uvex infradur plus | CA uncoated | CA anti-fog on the inside | Scratch-resistant on both sides | Scratch-resistant + anti-fog | Uncoated | Page |
|-------|---------------------------------|--|---|---------------------------|------------------|-----------------------------|--------------------------|----------------------|------------------------|---------------------|--------------------------------|-----------------------------|---------------|--------------------|-------------|---------------------------|---------------------------------|------------------------------|----------|-------|
| 9199 | uvex x-fit pro | Plastic temple spectacles | 5 PC | ■ | | ■ | | | | | | | | | | | | | | 25 |
| 9199 | uvex x-fit pro (without Slider) | Plastic temple spectacles | 5 PC | ■ | | ■ | | | | | | | | | | | | | | 25 |
| 9231 | uvex polavision | Plastic temple spectacles | PC | | | | | | | | | | | | | | | ■ | | 43 |
| 9301 | uvex ultravision | Safety goggles | 4 PC | | ■ | ■ | | | | | | | | | | ■ | | | | 54/55 |
| 9301 | uvex ultravision | Replacement lenses | 4 PC | | ■ | | | | | | | | | | | ■ | | | | 55 |
| 9300 | uvex ultravision | Tear-off films | 10 PC | | | | | | | | | | | | | | | | | 55 |
| 9301 | uvex ultravision faceguard | Safety goggles | 4 PC | | | ■ | | | | | | | | | | | | | | 56 |
| 9301 | uvex ultravision | Goggles with helmet attachment | 4 PC | | | | | | | | | | | | | ■ | | | | 56 |
| 9301 | uvex ultravision | Mouth shield | PC | | | | | | | | | | | | | | | | ■ | 56 |
| 9301 | uvex ultravision | Safety goggles – welding protection | 4 PC | | | | | | | | | | | ■ | | | | | | 65 |
| 9302 | uvex ultrasonic | Safety goggles | 4 PC | | | ■ | ■ | | | | | | | | | | | | | 53 |
| 9302 | uvex ultrasonic | Replacement lenses | 4 PC | | | ■ | | | | | | | | | | | | | | 53 |
| 9302 | uvex ultrasonic | Goggles with helmet attachment | 4 PC | | | | ■ | | | | | | | | | | | | | 56 |
| 9302 | uvex ultrasonic CR | Safety goggles | 4 PC | | | | | | | ■ | | | | | | | | | | 52 |
| 9302 | uvex ultrasonic flip-up | Safety goggles – welding protection | 4 PC | | | ■ | | | | | | | ■ | | | | | | | 65 |
| 9302 | uvex ultrasonic flip-up | Replacement lenses | 4 PC | | | | | | | | | | ■ | | | | | | | 65 |
| 9305 | uvex 9305 | Safety goggles | 4 PC | | | | | | | | | | | | | ■ | | | | 57 |
| 9307 | uvex carbonvision | Safety goggles | 5 PC | | | | ■ | | | | | | | | | | | | | 57 |
| 9308 | uvex u-sonic | Safety goggles | 5 PC | | ■ | ■ | ■ | | | | | | | | | | | | | 51 |
| 9308 | uvex u-sonic | Safety goggles | 5 PC | ■ | | | | | | | | | | | | | | | | 51 |
| 9309 | uvex pheos cx2 sonic | Safety goggles | 5 PC | | | | ■ | | | | | | | | | | | | | 50 |
| 9320 | uvex megasonic | Safety goggles | 4 PC | | | ■ | | | | | | | | | | | | | | 49 |
| 9405 | uvex 9405 | Safety goggles | 4 PC | | | | | | | | | | | | | ■ | | | | 57 |
| 9405 | uvex 9405 | Replacement lenses | 4 PC | | | | | | | | | | | | | ■ | | | | 57 |
| 6118 | | Safety eyewear case | 5 PC | | | | | | | | | | | | | | | | | 69 |
| 9972 | | Microfibre cloth | BG | | | | | | | | | | | | | | | | | 67 |
| 9954 | | Safety eyewear case | 5 PC | | | | | | | | | | | | | | | | | 68/69 |
| 9954 | | Carry case | PC | | | | | | | | | | | | | | | | | 69 |
| 9954 | | Carry case | 5 PC | | | | | | | | | | | | | | | | | 69 |
| 9957 | | Display | PC | | | | | | | | | | | | | | | | | 67 |
| 9957 | | SECU box | PC | | | | | | | | | | | | | | | | | 67 |
| 9958 | uvex x-fit/x-fit pro | Comfort Slider | BG (incl. 5 PR) | | | | | | | | | | | | | | | | | 27 |
| 9958 | | Neck hang cord | 5 PC | | | | | | | | | | | | | | | | | 70 |
| 9958 | | Headband | 5 PC | | | | | | | | | | | | | | | | | 70 |
| 9958 | uvex pheos/uvex pheos s | Headband | 5 PC | | | | | | | | | | | | | | | | | 32/70 |
| 9958 | uvex i-3/uvex i-3s | Neck hang cord | 5 PC | | | | | | | | | | | | | | | | | 35/70 |
| 9958 | uvex x-fit/x-fit pro | Headband | 5 PC | | | | | | | | | | | | | | | | | 25/71 |
| 9959 | | Neck hang cord | 5/10 PC | | | | | | | | | | | | | | | | | 71 |
| 9963 | | Cleaning towelettes | PC | | | | | | | | | | | | | | | | | 66 |
| 9963 | | Wall holder | PC | | | | | | | | | | | | | | | | | 66 |
| 9963 | | Magnetic wall bracket | PC | | | | | | | | | | | | | | | | | 66 |
| 9970 | | Cleaning station | PC | | | | | | | | | | | | | | | | | 66 |
| 9971 | | Replacement cleaning papers | PC | | | | | | | | | | | | | | | | | 66 |
| 9972 | | Cleaning fluid | PC | | | | | | | | | | | | | | | | | 66 |
| 9973 | | Plastic pump | PC | | | | | | | | | | | | | | | | | 66 |
| 9999 | uvex x-fit/x-fit pro | uvex LED mini light including adapter (right and left) | PC | | | | | | | | | | | | | | | | | 25 |

laservision

Innovative laser protection solutions



Laser protection goggles and cabin windows

Due to its physical properties of laser light, such as radiation intensity and focusing coherence, it is potentially hazardous especially for the eyes, particularly for the eyes. In response to these risks, the valid laser protection standards (EN 207 and EN 208) and safety regulations (OStrV and TROS Laser) prescribe the use of laser protection eyewear. The core focus of the laservision product portfolio is laser protection eyewear with special coated or absorbent lenses and plastics. We have more than 30 years of experience of laser technology. The laservision range also offers many of these filter materials as windows (in accordance with DIN EN 60825-4) for installation in machine housings or partitions.



Screens

Alternatively, it is possible to screen out laser radiation by mechanical means to protect potentially endangered change to: at risk personnel during laser operation Screens against laser radiation may take the form of curtains, partitions or even fixed insulating walls. These can be installed in the workplace, or they may be integrated in machinery housing. laservision offers standard and customer-specific solutions for screening in compliance with the applicable standards. Due to the wide range of materials and solutions available, we work with our customers on their sites to determine the best possible solutions for identified laser radiation risks.



laservision

LASERVISION GmbH & Co. KG
Phone: +49 911 9736-8100
E-Mail: info@lv.com · uvex-laservision.de



Hearing Protection

Hearing Protection

All ears when it comes to safety

Noise-induced hearing loss is still one of the most common occupational hazards of all.

It develops painlessly, is progressive and generally goes unnoticed. It is the fact that it's irreversible which makes it so serious. The risk to hearing and the importance of hearing protection are often recognised too late.

Only those who suffer from hearing loss really understand just how essential a good sense of hearing is and that protecting it should be a top priority.

What is noise?

Loud sounds which comprise noise not only pose a risk to hearing but can also be distracting and debilitating.

Persistent low-grade sounds such as a clock ticking or a dripping tap can also affect concentration levels.

What are the consequences of noise?

We use our hearing continuously, it never gets a break and cannot be "switched off". We are exposed to noise every day, all day, from multiple sources so our hearing is under constant stress.

These daily demands on our ears can lead to irreversible noise-induced hearing loss. But, it's not just our hearing that is affected; noise means stress for the entire body. Noise affects us subconsciously and can lead to difficulty concentrating, gastrointestinal illness, elevated blood pressure and increased risk of a heart attack.

Adverse health effects caused by harmful noise levels

Listed below are the maximum periods of time a person should be exposed to harmful noise per day without wearing hearing protection.

| | | | |
|--------|------------|--------|-------------|
| 85 dB | 8 hours | 103 dB | 7.5 minutes |
| 88 dB | 4 hours | 106 dB | 4 minutes |
| 91 dB | 2 hours | 109 dB | 2 minutes |
| 94 dB | 1 hour | 112 dB | 1 minute |
| 97 dB | 30 minutes | 115 dB | 30 seconds |
| 100 dB | 15 minutes | | |





Tests and standards

All uvex hearing protection products comply with the CE standard and have been tested in accordance with the applicable European standards in line with current EU legislation.

Continuous quality assurance with ISO 9001/2015 and OHSAS 18001:2007.

Applicable DIN EN norms are:

- EN 352: Part 1 Ear muffs
- EN 352: Part 2 Ear plugs
- EN 352: Part 3 Ears muffs attached to a safety helmet

Signal recognition

When a risk assessment is carried out by a Health and Safety professional or external qualified service provider the result determines the type of hearing protection to be provided in specific workplaces.

The classifications are defined as follows:

- S Signals audible in rail track superstructure construction
- V Signals audible when driving a vehicle in road traffic
- W General warning signals, informative operating sounds and speech communication audible
- X Extrem flachdämmender Gehörschutz
- E Signals audible for multiple-unit drivers and shunting train drivers in railway operations
 - E₁: very high suitability (besonders mit Hörminderung)
 - E₂: high suitability
 - E₃: limited suitability

Abbreviations for protection values with explanations

| | |
|--------------------------------|--|
| SNR | Single Number Rating/average protection capacity |
| f/Hz | Frequency given as a unit of Hertz |
| (MA) Mean Attenuation | Mean attenuation |
| (SD) | Standard Deviation |
| (APV) Assumed Protection Value | Assumed protection value |
| HML value | H: Attenuation value at high frequencies |
| | M: Attenuation value at medium frequencies |
| | L: Attenuation value at low frequencies |



Hearing protection

Size and fit

Everyone's ear canal is unique – much like a fingerprint. Which is why it's all the more important that you choose adequate and suitable hearing protection that is the correct size to achieve a good fit. uvex offers a complete range of hearing protection to ensure all wearers are able to achieve a fit that's right for them.

Choosing the wrong size can severely reduce the protection value, exposing wearers to harmful noise, and makes the ear plugs uncomfortable to wear.

- if the earplugs are too large, they are unlikely to sit deep enough in the ear canal, so the specified protection level cannot be achieved. They'll also feel uncomfortable
- if the earplugs are too small, although they may be comfortable to wear, there could be noise leakage and reduced protection capacity which over time can cause noise-induced hearing loss.
- round earplugs don't necessarily completely seal an oval-shaped ear canal. It is on this premise that we developed the uvex xact-fit range of hearing protectors.

It is best to try different sizes to find the one that gives you the best protection and fit. With the uvex com4-fit and uvex x-fit, we offer something for the majority of ear canal shapes.

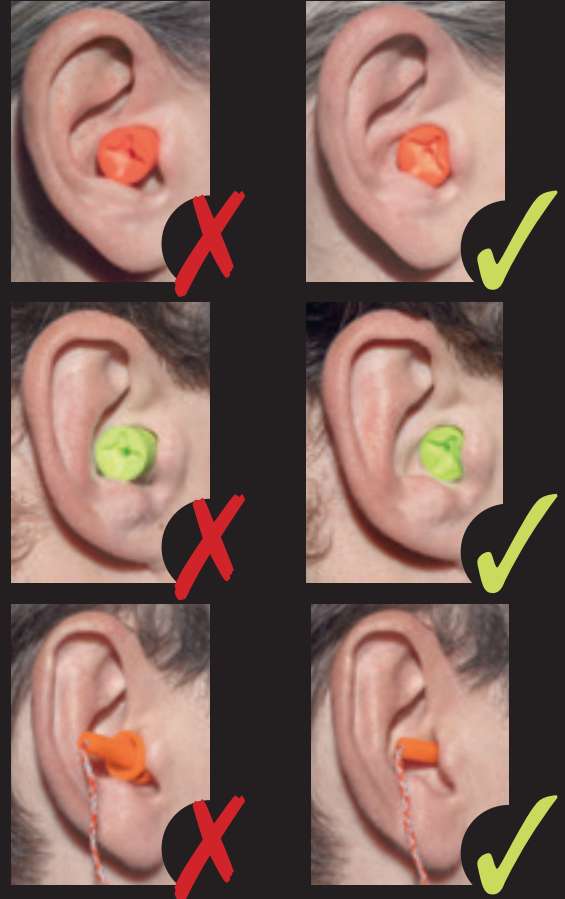

Look out for the different sizes



The cross-section of an ear canal is oval shaped

Anyone can get used to wearing hearing protection; you just need to choose the right type of protection for you.

- wearing time
- noise levels
- choose earplugs according to the size of your ear canal
- earmuffs are not recommended for hot workplaces
- fitting accuracy (glasses wearers)

- for earmuff wearers, the weight should be taken into consideration
- handling (dirty hands, gloves, disabilities)
- compatibility with other PPE (helmet, glasses, respiratory protection)

The right hearing protection can make even the loudest noises more comfortable.

Hearing Protection

Different situations, different ears



A unique design, even inside the earplugs

| | | | | |
|----------------------|--|--|--|--|
| uvex xtra-fit | | | | <ul style="list-style-type: none"> • intricate recess design for long-term wearer comfort • designed to minimise pressure in the ear canal |
| uvex x-fit | | | | <ul style="list-style-type: none"> • grip section for easy insertion and removal |
| uvex com4-fit | | | | |
| uvex hi-com | | | | <p>Defined protection zone for controlled noise reduction, resulting in excellent speech and signal recognition and good communication</p> |
| uvex xact-fit | | | | |

Hearing protection for every situation

There are many types of uvex hearing protection which are suitable for different situations and if you work in or are passing through high noise level areas you need the right level of protection.

noise while not compromising your ability to hear and communicate. The below chart gives you an overview of which uvex earplug may be suitable based on the noise level.

It is important to strike the right balance between the need to adequately protect your hearing from dangerous

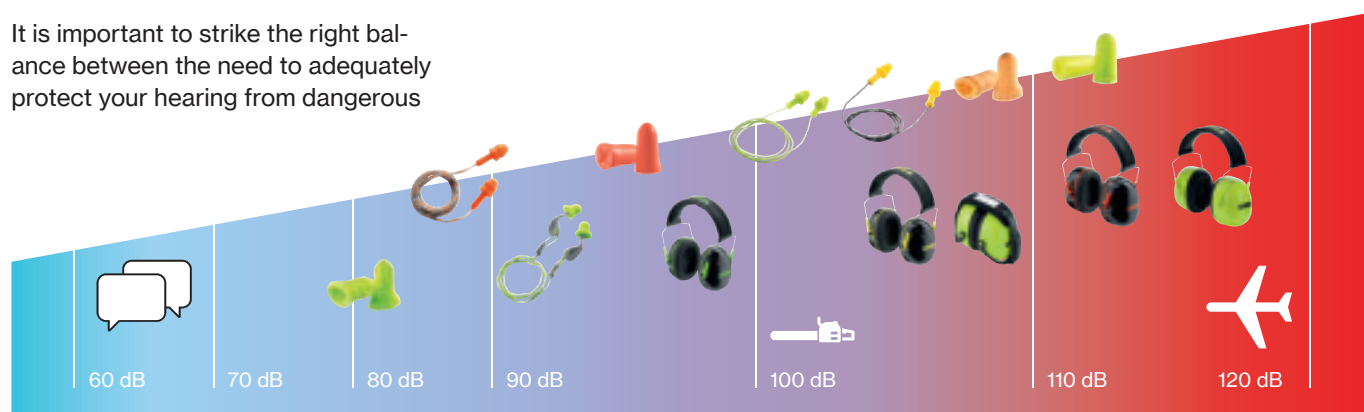

Hearing protection

The uvex xact-fit family

Using earplugs has never been easier

Easy, fast and accurate insertion

Medium protection capacity for excellent speech and signal recognition for easy communication

Replacement earplugs are available, for a cost-effective and environmentally conscious choice

No rolling required, so they can be used with dirty hands or while wearing gloves

Ergonomically shaped stems make fitting easy, hygienic, accurate and achieves a high level of wearer comfort

Thumb indentations with left and right marking ensures correct insertion and easy fitting

The shape means it fits most ear canals securely and comfortably



The uvex xact-fit family

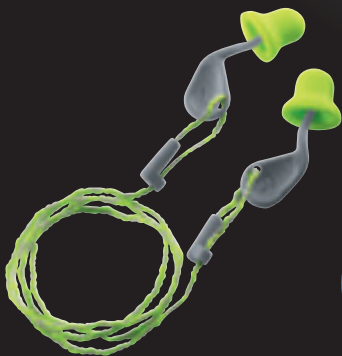

uvex xact-fit

Catalogue page 88



uvex xact-fit detec

Catalogue page 90



uvex xact-fit multi reusable

Catalogue page 88

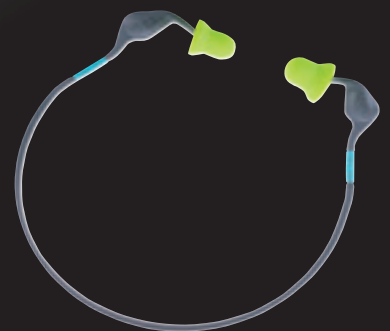

uvex xact-band

Catalogue page 92

Hearing protection

The uvex xact-fit family



uvex xact-fit – intelligent ergonomics

A new dimension of wearer comfort

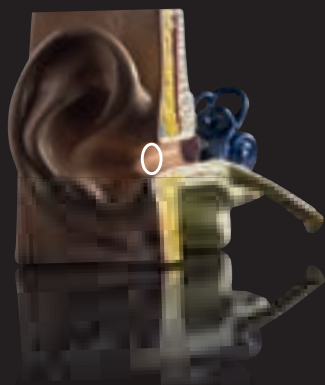

The cross-section of an ear canal is oval shaped

The stem is ergonomically shaped to fit either the left or right ear to increase wearer comfort and make the earplugs easier to insert and remove.

The design is easily identifiable from a distance, making it easier to monitor usage in accordance with your company's regulations.

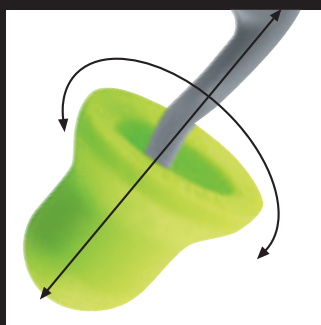
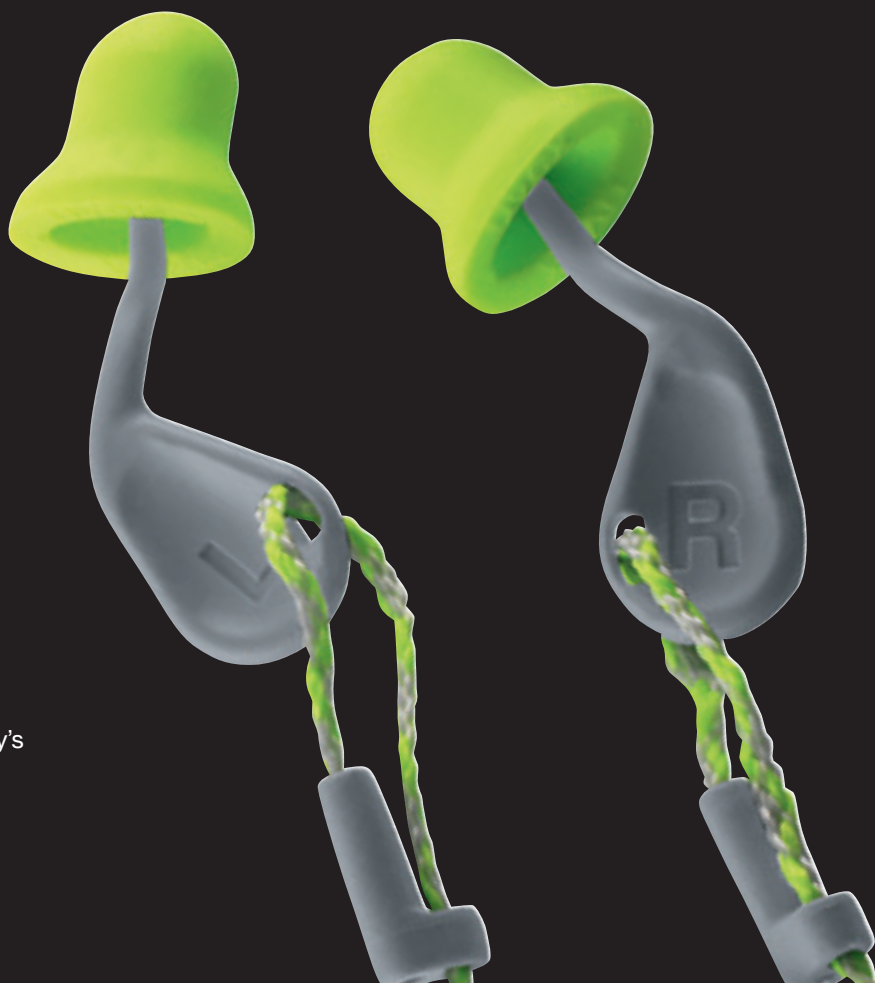

Perfect fit

Oval-shaped foam earplugs mimic the natural shape of the ear canal for low pressure fit and enhanced comfort

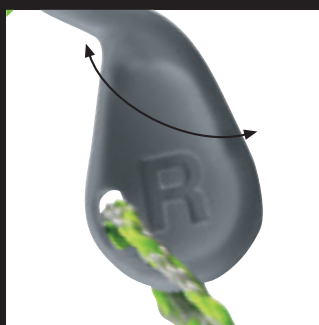

Ergonomic thumb indentations

The ergonomic thumb indentations with left and right marking ensures correct insertion and easy fitting



Adjustable cord

Hearing Protection

Disposable ear plugs

uvex hi-com

A unique design – even on the inside

patented

Designed to minimise pressure in the ear canal

Reduced risk of over protection and feelings of isolation

Intricate recess design for long-term wearer comfort

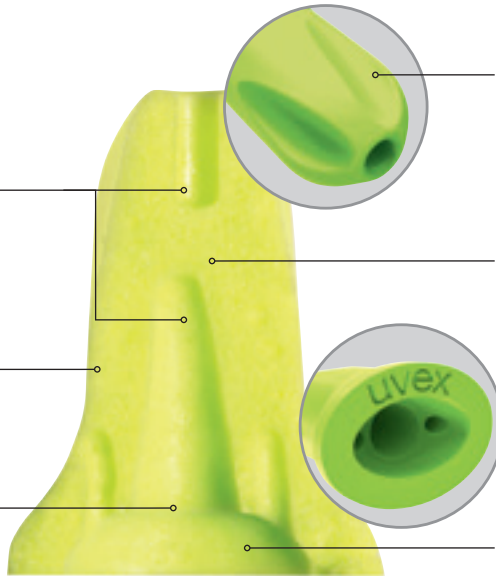

Large surface area delivers softer acoustics and absorbs inner ear sounds which can become obvious when wearing hearing protection in quieter areas

Defined protection zone for controlled noise reduction, resulting in excellent speech and signal recognition and good communication

Grip recess for easy removal



2112100
2112095



2112106



2112095
Table-top dispenser box



2112101

uvex hi-com

- delivers low, flat attenuation allowing for excellent speech and sound recognition
- large surface area delivers softer acoustics and absorbs inner ear sounds which can become obvious when wearing hearing protection in quieter areas
- available in two colours
- additional requirement: W

| uvex hi-com | | |
|-------------------|-------------------------------|-------------------------------|
| Art. no. | 2112100 | 2112101 |
| Design | without cord | with cord |
| Standard | EN 352-2 | EN 352-2 |
| Colour | lime | lime |
| Order unit | CT | CT |
| Content | 200 PR, packed in pairs in CT | 100 PR, packed in pairs in CT |

| uvex hi-com | | |
|-------------------|-------------------------------|-------------------------------|
| Art. no. | 2112095 | 2112106 |
| Design | without cord | without cord |
| Standard | EN 352-2 | EN 352-2 |
| Colour | lime | beige |
| Order unit | CT | CT |
| Content | 100 PR, packed in pairs in CT | 200 PR, packed in pairs in CT |

| SNR: 24 dB | H: 26 dB | M: 20 dB | L: 18 dB | | | | | |
|------------|----------|----------|----------|------|------|------|------|------|
| f/Hz | 63 | 125 | 250 | 500 | 1000 | 2000 | 4000 | 8000 |
| MA dB | 17.5 | 20.0 | 20.4 | 22.8 | 24.6 | 31.2 | 37.5 | 40.3 |
| SD dB | 6.4 | 2.9 | 3.2 | 4.7 | 5.1 | 5.0 | 5.9 | 6.6 |
| APV dB | 11.2 | 17.0 | 17.2 | 18.1 | 19.5 | 26.2 | 31.6 | 33.7 |

Refill boxes for uvex "one2click" dispenser on page 86

MADE IN SWEDEN

Hearing Protection

Disposable ear plugs



2112012

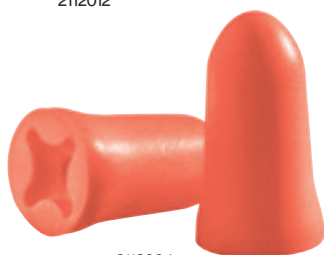

2112004
2112096
2112131

uvex com4-fit

- disposable earplugs with a compact, ergonomic design
- perfect for narrow and smaller ear canals
- suitable for use in high noise environments
- patented x-grip technology reduces pressure on the ear canal and aids easy, hygienic removal
- increased wearing comfort, when worn for extended periods
- additional requirement: W, X, S, V, E₁

| uvex com4-fit | | | | |
|---------------|-------------------------------|-------------------------------|--------------------|-------------------------------|
| Art. no. | 2112004 | 2112096 | 2112131 | 2112012 |
| Design | without cord | without cord | without cord | with cord |
| Standard | EN 352-2 | EN 352-2 | EN 352-2 | EN 352-2 |
| Colour | light orange | light orange | light orange | light orange |
| Order unit | CT | CT | CT | CT |
| Content | 200 PR, packed in pairs in CT | 100 PR, packed in pairs in CT | 15 PR, loose in CT | 100 PR, packed in pairs in CT |

| SNR: 33 dB | H: 33 dB | M: 30 dB | L: 29 dB | | | | | |
|------------|----------|----------|----------|------|------|------|------|------|
| f/Hz | 63 | 125 | 250 | 500 | 1000 | 2000 | 4000 | 8000 |
| MA dB | 28.9 | 31.0 | 33.6 | 33.8 | 33.6 | 36.2 | 40.6 | 44.3 |
| SD dB | 3.4 | 5.2 | 5.4 | 5.4 | 4.0 | 4.2 | 3.7 | 2.9 |
| APV dB | 25.5 | 25.8 | 28.2 | 28.4 | 29.6 | 32.0 | 36.9 | 41.4 |



2112010



2112001
2112094
2112133

uvex x-fit

- tapered plug shape ensures natural, pressure free fit – maximising comfort and protection levels
- suitable for use in high noise environments
- patented x-grip technology reduces pressure on the ear canal and aids easy, hygienic removal
- additional requirement: W, X, S, V, E₁

| uvex x-fit | | | | | |
|------------|-------------------------------|-------------------------------|--------------------|--------------------|-------------------------------|
| Art. no. | 2112001 | 2112094 | 2112013 | 2112013 | 2112010 |
| Design | without cord | without cord | without cord | without cord | with cord |
| Standard | EN 352-2 | EN 352-2 | EN 352-2 | EN 352-2 | EN 352-2 |
| Colour | lime | lime | lime | lime | lime |
| Order unit | CT | CT | CT | CT | CT |
| Content | 200 PR, packed in pairs in CT | 100 PR, packed in pairs in CT | 50 PR, loose in CT | 15 PR, loose in CT | 100 PR, packed in pairs in CT |

| SNR: 37 dB | H: 36 dB | M: 34 dB | L: 34 dB | | | | | |
|------------|----------|----------|----------|------|------|------|------|------|
| f/Hz | 63 | 125 | 250 | 500 | 1000 | 2000 | 4000 | 8000 |
| MA dB | 35.3 | 38.4 | 39.3 | 40.8 | 38.9 | 37.8 | 45.9 | 45.1 |
| SD dB | 4.2 | 6.3 | 5.3 | 5.5 | 5.5 | 4.3 | 3.9 | 4.6 |
| APV dB | 31.1 | 32.1 | 34.0 | 35.3 | 33.4 | 33.5 | 42.0 | 40.5 |



2112060
2112093

uvex xtra-fit

- disposable earplugs ideal for larger ear canals
- adapts to the shape and size of the ear canal, thereby optimising fit and protection
- very soft and comfortable to wear
- additional requirement: W, X, S, V, E₁

| uvex xtra-fit | | |
|---------------|-------------------------------|-------------------------------|
| Art. no. | 2112060 | 2112093 |
| Design | without cord | without cord |
| Standard | EN 352-2 | EN 352-2 |
| Colour | orange | orange |
| Order unit | BG | CT |
| Content | 200 PR, packed in pairs in BG | 100 PR, packed in pairs in CT |

| SNR: 36 dB | H: 34 dB | M: 33 dB | L: 32 dB | | | | | |
|------------|----------|----------|----------|------|------|------|------|------|
| f/Hz | 63 | 125 | 250 | 500 | 1000 | 2000 | 4000 | 8000 |
| MA dB | 32.7 | 34.8 | 36.8 | 38.9 | 36.9 | 36.2 | 44.0 | 41.5 |
| SD dB | 4.6 | 4.4 | 5.6 | 5.2 | 4.7 | 3.7 | 4.0 | 5.0 |
| APV dB | 28.1 | 30.4 | 31.2 | 33.7 | 32.2 | 32.5 | 40.0 | 36.5 |

Hearing Protection

Disposable ear plugs · Earplug dispenser · Refill packs



2112000
2111988

2111989



2111990

2111991

2111992

uvex dispenser “one2click”

- Easy-to-use and robust hearing protection dispenser with two different mounting options
- Earplugs available to hand with just one click
- ensures hygienic dispensing whenever it's needed
- magnetic wall mount requires no drilling
- can be refilled even if the container is not empty
- Collecting tray prevents earplugs from falling on the floor
- Suitable for all uvex disposable earplugs
- Quantities: 600 pairs (xtra-fit 500 pairs)
- Magnetic variant for flexible use on all magnetic surfaces (2112988)
- stationary wall mounting using screws (2112000)
- Magnetic wall mount can be retrofitted individually (2112989)

uvex dispenser “one2click”

| | | |
|-------------------|--------------------------|-----------------------------|
| Art. no. | 2112000 | 2111988 |
| Mounting | empty, screw mounting | empty, magnetic mounting |
| Order unit | CT | CT |

uvex magnetic bracket for dispenser

| | |
|-------------------|---|
| Art. no. | 2111989 |
| Mounting | retrofit kit for dispenser for magnetic mounting |
| Material | polished steel |
| Order unit | CT |

uvex dispenser “one2click”

| | | | |
|-------------------|--|--|--|
| Art. no. | 2111990 | 2111991 | 2111992 |
| Type | ready to use (filled), screw mounting | ready to use (filled), screw mounting | ready to use (filled), screw mounting |
| | 600 pairs of x-fit | 600 pairs of com4-fit | 600 pairs of hi-com |
| Order unit | CT | CT | CT |

► For the ready-to-use magnetic version, the magnetic plate (2112989) must be ordered separately

uvex dispenser “one2click” – Refill packs

| | uvex x-fit | uvex com4-fit | uvex xact-fit |
|-------------------|--|--|---------------------------|
| Art. no. | 2112022 | 2112023 | 2124003 |
| Design | without cord | without cord | replacement earplugs |
| Standard | EN 352-2 | EN 352-2 | EN 352-2 |
| | additional requirement: S, V, W, E, | additional requirement: S, V, W, E, | additional requirement: W |
| SNR | 37 dB (see page 85) | 33 dB (see page 85) | 26 dB (see page 88) |
| Colour | lime | light orange | lime |
| Size | M | S | M |
| Order unit | CT | CT | CT |
| Content | 300 PR, loose in CT | 300 PR, loose in CT | 400 PR, loose in CT |

| | uvex hi-com | uvex hi-com | uvex xtra-fit |
|-------------------|---------------------------|---------------------------|--|
| Art. no. | 2112118 | 2112119 | 2112061 |
| Design | without cord | without cord | without cord |
| Standard | EN 352-2 | EN 352-2 | EN 352-2 |
| | additional requirement: W | additional requirement: W | additional requirement: S, V, W, E, |
| SNR | 24 dB (see page 84) | 24 dB (see page 84) | 36 dB (see page 85) |
| Colour | lime | beige | orange |
| Size | M | M | L |
| Order unit | CT | CT | BG |
| Content | 300 PR, loose in CT | 300 PR, loose in CT | 250 PR, loose in BG |



Hearing Protection

Making the right choice is essential



What level of protection is required? Objective: noise level – SNR value

Noise levels in the workplace must be measured first in order to determine what level of protection is required. The Health and Safety professional or external qualified service providers should conduct tests using approved test equipment.

The continuous noise level and, if necessary, the peak emission noise level are measured, enabling a noise profile to be recorded.

Appropriate hearing protection can then be selected using the SNR method.

The objective when choosing suitable hearing protection is to achieve an effective residual noise level of between 70 dB and 80 dB for the wearer.

If the protection level is too high (over-protection), this can result in the inability to communicate and the risk of not hearing critical messages, instructions or signals.

Example:

Noise level 100 dB – uvex xact-fit, SNR 26 dB = 74 dB

RANGE

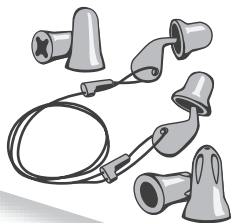

uvex disposable hearing protection plugs

Outstanding safety for one-time use: uvex disposable hearing protection plugs offer excellent wearer comfort when worn for long periods.

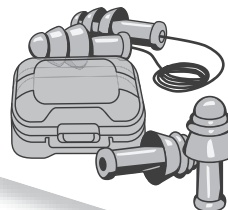

uvex reusable ear plugs

Readily available and easy to clean: uvex reusable ear plugs with hygiene boxes are reliable companions for your everyday work.

USE

To guarantee optimum hearing protection, uvex disposable hearing protection plugs must be used correctly.

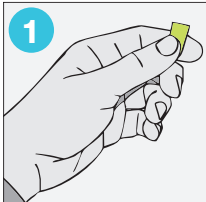

1 Briefly roll down uvex disposable hearing protection plugs.



2 Put your arm over your head and move the ear slightly upwards to straighten your auditory canal. This achieves a better fit.

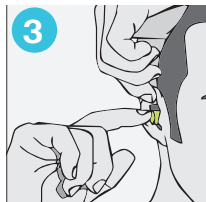

3 Insert plugs and hold in place while they expand. If they are not visible from the front, then they are in the right position.

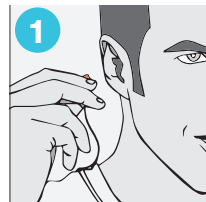

1 Take uvex reusable ear plugs by the handles and place the cord around your neck.

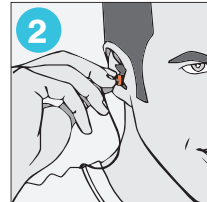

2 Insert uvex ear plugs into the auditory canal, applying gentle pressure.

HYGIENE

In dirty working environments, particles can easily stick to the surface of materials and cause minor injuries in the ears.

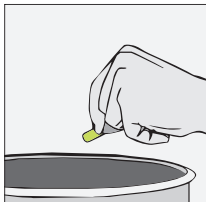

Please dispose of uvex disposable hearing protection plugs after each use.

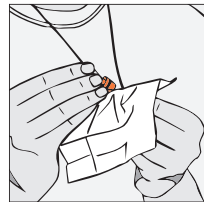

Easy to clean with uvex damp cleaning cloth.

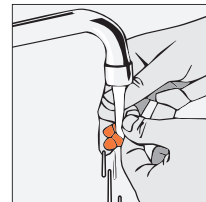

Alternatively, clean them with water and mild soap.

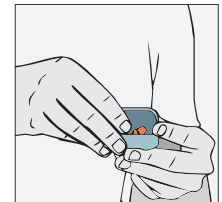

Dry them and store in the uvex hygiene box when not in use.

MORE INFORMATION



Simply scan in the adjacent QR code with a smartphone or tablet.

You can also watch the application videos online using the following link: uvex-safety.com/plugs

Detailed application videos show you how to use uvex disposable hearing protection plugs properly.

Hearing Protection

Disposable earplugs · Reusable earplugs · uvex xact-fit



2124001



minibox
2124001



2124002

uvex xact-fit

- disposable earplugs uniquely shaped to match the anatomy of the ear canal
- tapered plug shape ensures natural, pressure free fit – maximising comfort and protection levels
- left / right pod carriers simplify fitting and ensure accurate fit every-time
- replacement earplugs can be dispensed through the standard uvex wall mounted dispenser unit
- sealed PU foam reduces the potential for contamination
- adjustable neck cord can be altered to wearers requirements for increased safety
- additional requirement: W (2124001)

| uvex xact-fit | | uvex xact-fit replacement earplugs | |
|-------------------|-------------------------------|------------------------------------|----------------------------------|
| Art. no. | 2124001 | | 2124002 |
| Design | with reusable pin, in minibox | | replacement earplugs, in minibox |
| Standard | EN 352-2 | | EN 352-2 |
| Colour | lime | | lime |
| Order unit | CT | | CT |
| Content | 50 PR, packed in pairs in CT | | 250 PR, CT of 5 pairs |

| SNR: 26 dB | H: 28 dB | M: 23 dB | L: 19 dB | | | | | |
|------------|----------|----------|----------|------|------|------|------|------|
| f/Hz | 63 | 125 | 250 | 500 | 1000 | 2000 | 4000 | 8000 |
| MA dB | 16.6 | 19.4 | 22.0 | 25.6 | 27.5 | 31.8 | 34.4 | 36.9 |
| SD dB | 5.4 | 4.9 | 4.2 | 4.9 | 4.7 | 3.8 | 4.4 | 6.0 |
| APV dB | 11.2 | 14.5 | 17.8 | 20.7 | 22.8 | 28.0 | 30.0 | 30.9 |



2124019



2124017

uvex xact-fit multi reusable

- Reusable earplugs with thumb indentations
- oval-shaped earplugs mimics the natural shape of the ear canal for optimum fit and comfort
- interchangeable replacement earplugs
- can be handled with dirty hands or while wearing gloves
- available in two sizes
- additional requirement: W

| uvex xact-fit multi reusable S | | uvex xact-fit multi reusable M/L | |
|--------------------------------|--|----------------------------------|--|
| Art. no. | 2124019 | | 2124017 |
| Design | with oval-shaped reusable earplugs, in minibox | | with oval-shaped reusable earplugs, in earplug box |
| Standard | EN 352-3 | | EN 352-3 |
| Colour | grey, transparent | | grey, transparent |
| Size | S | | S |
| Order unit | CT | | CT |
| Content | 50 PR, packed in pairs in CT | | 50 PR, packed in pairs in CT |



2124020



2124018

| uvex xact-fit multi reusable M/L | | uvex xact-fit multi reusable S | |
|----------------------------------|--|--------------------------------|--|
| Art. no. | 2124020 | | 2124017 |
| Design | with oval-shaped reusable earplugs, in minibox | | with oval-shaped reusable earplugs, in earplug box |
| Standard | EN 352-3 | | EN 352-3 |
| Colour | grey, transparent | | grey, transparent |
| Size | M/L | | M/L |
| Order unit | CT | | CT |
| Content | 50 PR, packed in pairs in CT | | 50 PR, packed in pairs in CT |

| SNR: 26 dB | H: 27 dB | M: 23 dB | L: 22 dB | | | | | |
|------------|----------|----------|----------|------|------|------|------|--|
| f/Hz | 125 | 250 | 500 | 1000 | 2000 | 4000 | 8000 | |
| MA dB | 26.9 | 25.4 | 26.1 | 28.3 | 31.9 | 32.8 | 37.2 | |
| SD dB | 4.4 | 4.5 | 5.4 | 5.5 | 4 | 6.9 | 6.7 | |
| APV dB | 22.5 | 20.9 | 20.7 | 22.8 | 27.9 | 25.9 | 30.5 | |

Hearing Protection

Reusable ear plugs



minibox
2111201



2111237

uvex whisper

- easy-to-clean corded earplugs
- smooth, dirt-repellent surface can be easily cleaned using soap and water
- earplug box for hygienic storage when not in use
- with the cord, the earplugs are conveniently to hand – in low-noise areas, the earplugs can be worn comfortably around the neck
- additional requirement: W, S

| uvex whisper | |
|--------------|---|
| Art. no. | 2111201 2111237 |
| Design | with cord, in minibox with cord, in earplug box |
| Standard | EN 352-2 EN 352-2 |
| Colour | orange orange |
| Order unit | CT CT |
| Content | 50 PR, in pairs in CT 50 PR, in pairs in CT |

| SNR: 23 dB | H: 24 dB | M: 20 dB | L: 17 dB | | | | | |
|------------|----------|----------|----------|------|------|------|------|------|
| f/Hz | 63 | 125 | 250 | 500 | 1000 | 2000 | 4000 | 8000 |
| MA dB | 23.7 | 23.2 | 21.1 | 22.6 | 24.8 | 31.7 | 33.4 | 39.4 |
| SD dB | 5.6 | 5.8 | 6.8 | 5.2 | 5.7 | 6.0 | 9.5 | 8.2 |
| APV dB | 18.1 | 17.4 | 14.3 | 17.4 | 19.1 | 25.7 | 23.9 | 31.2 |



minibox
2111212



2111238

uvex whisper +

- easy-to-clean reusable corded earplugs
- smooth, dirt-repellent surface can be easily cleaned using soap and water
- earplug box for hygienic storage when not in use
- with the cord, the earplugs are conveniently to hand – in low-noise areas, the earplugs can be worn comfortably around the neck
- Zusatzanforderung: W, X, S, V, E,

| uvex whisper + | |
|----------------|---|
| Art. no. | 2111212 2111238 |
| Design | with cord, in minibox with cord, in earplug box |
| Standard | EN 352-2 EN 352-2 |
| Colour | lime lime |
| Order unit | CT CT |
| Content | 50 PR, in pairs in CT 50 PR, in pairs in CT |

| SNR: 27 dB | H: 27 dB | M: 24 dB | L: 22 dB | | | | | |
|------------|----------|----------|----------|------|------|------|------|------|
| f/Hz | 63 | 125 | 250 | 500 | 1000 | 2000 | 4000 | 8000 |
| MA dB | 26.6 | 26.9 | 24.3 | 26.1 | 28.8 | 32.8 | 32.6 | 38.1 |
| SD dB | 6.1 | 6.1 | 4.1 | 5.1 | 5.1 | 5.0 | 6.5 | 5.3 |
| APV dB | 20.5 | 20.8 | 20.2 | 21.0 | 23.7 | 27.8 | 26.1 | 32.8 |

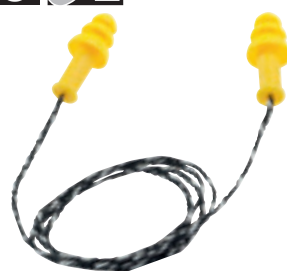

2111235

uvex whisper supreme

- easy-to-clean reusable corded earplugs
- smooth, dirt-repellent surface can be easily cleaned using soap and water
- earplug box for hygienic storage when not in use
- with the cord, the earplugs are conveniently to hand – in low-noise areas, the earplugs can be worn comfortably around the neck
- Zusatzanforderung: W

| uvex whisper supreme | |
|----------------------|---------------------------|
| Art. no. | 2111235 |
| Design | with cord, in earplug box |
| Standard | EN 352-2 |
| Colour | yellow |
| Order unit | CT |
| Content | 50 PR, in pairs in CT |

| SNR: 30 dB | H: 31 dB | M: 27 dB | L: 26 dB | | | | |
|------------|----------|----------|----------|------|------|------|------|
| f/Hz | 125 | 250 | 500 | 1000 | 2000 | 4000 | 8000 |
| MA dB | 33.8 | 29.2 | 32.7 | 30.0 | 36.0 | 34.3 | 41.0 |
| SD dB | 5.1 | 4.6 | 4.9 | 5.0 | 4.0 | 3.6 | 4.4 |
| APV dB | 28.7 | 24.5 | 27.8 | 25.0 | 32.0 | 30.6 | 36.6 |

MADE IN SWEDEN

Hearing Protection

Detectable ear plugs



2112114



2112011



2124011



2124013



minibox

uvex hi-com detec

- metal powder in cord allows full detection even if the cord is shredded, coloured blue for easy recognition
- oval pods match the shape of the outer ear ensuring pressure free, comfortable fit
- delivers low, flat attenuation allowing for excellent speech and sound recognition
- large surface area delivers softer acoustics and absorbs inner ear sounds which can become obvious when wearing hearing protection in quieter areas
- additional requirement: W

| | | | | | | | | | |
|-------------------|------------------------|--|--|--|--|--|--|--|--|
| uvex hi-com detec | | | | | | | | | |
| Art. no. | 2112114 | | | | | | | | |
| Design | with cord, detectable | | | | | | | | |
| Standard | EN 352-2 | | | | | | | | |
| Colour | blue | | | | | | | | |
| Order unit | CT | | | | | | | | |
| Content | 100 PR, in pairs in CT | | | | | | | | |

| SNR: 24 dB | H: 26 dB | M: 20 dB | L: 18 dB | | | | | | |
|------------|----------|----------|----------|------|------|------|------|------|--|
| f/Hz | 63 | 125 | 250 | 500 | 1000 | 2000 | 4000 | 8000 | |
| MA dB | 17.5 | 20.0 | 20.4 | 22.8 | 24.6 | 31.2 | 37.5 | 40.3 | |
| SD dB | 6.4 | 2.9 | 3.2 | 4.7 | 5.1 | 5.0 | 5.9 | 6.6 | |
| APV dB | 11.2 | 17.0 | 17.2 | 18.1 | 19.5 | 26.2 | 31.6 | 33.7 | |

uvex x-fit detec

- disposable earplugs coloured blue with metal component for easy detection
- suitable for use in high noise environments
- tapered shape matches the ear canal anatomy for comfortable and secure fit
- patented x-grip technology reduces pressure on the ear canal and aids easy, hygienic removal
- sealed PU foam reduces the potential for contamination
- additional requirement: W, X, S, V, E₁

| | | | | | | | | | |
|------------------|------------------------|--|--|--|--|--|--|--|--|
| uvex x-fit detec | | | | | | | | | |
| Art. no. | 2112011 | | | | | | | | |
| Design | with cord, detectable | | | | | | | | |
| Standard | EN 352-2 | | | | | | | | |
| Colour | blue | | | | | | | | |
| Order unit | CT | | | | | | | | |
| Content | 100 PR, in pairs in CT | | | | | | | | |

| SNR: 37 dB | H: 36 dB | M: 34 dB | L: 34 dB | | | | | | |
|------------|----------|----------|----------|------|------|------|------|------|--|
| f/Hz | 63 | 125 | 250 | 500 | 1000 | 2000 | 4000 | 8000 | |
| MA dB | 35.3 | 38.4 | 39.3 | 40.8 | 38.9 | 37.8 | 45.9 | 45.1 | |
| SD dB | 4.2 | 6.3 | 5.3 | 5.5 | 5.5 | 4.3 | 3.9 | 4.6 | |
| APV dB | 31.1 | 32.1 | 34.0 | 35.3 | 33.4 | 33.5 | 42.0 | 40.5 | |

uvex xact-fit detec

- disposable plugs with integrated metal elements makes both earplugs and cord detectable
- tapered plug shape ensures natural, pressure free fit – maximising comfort and protection levels
- left / right pod carriers simplify fitting and ensure accurate fit every-time
- adjustable neck cord can be altered to wearers requirements
- sealed PU foam reduces the potential for contamination for increased hygiene
- replacement pods prolong the life of the product
- additional requirement: W (2124011)

| | | | | | | | | | |
|---------------------|-------------------------------|--|--|--|----------------------|--|--|--|--|
| uvex xact-fit detec | | | | | | | | | |
| Art. no. | 2124011 | | | | 2124013 | | | | |
| Design | with reusable pin, detectable | | | | replacement earplugs | | | | |
| Standard | EN 352-2 | | | | EN 352-2 | | | | |
| Colour | blue | | | | blue | | | | |
| Order unit | CT | | | | CT | | | | |
| Content | 50 PR, in pairs in CT | | | | 400 PR, loose in CT | | | | |

| SNR: 26 dB | H: 28 dB | M: 23 dB | L: 19 dB | | | | | | |
|------------|----------|----------|----------|------|------|------|------|------|--|
| f/Hz | 63 | 125 | 250 | 500 | 1000 | 2000 | 4000 | 8000 | |
| MA dB | 16.6 | 19.4 | 22.0 | 25.6 | 27.5 | 31.8 | 34.4 | 36.9 | |
| SD dB | 5.4 | 4.9 | 4.2 | 4.9 | 4.7 | 3.8 | 4.4 | 6.0 | |
| APV dB | 11.2 | 14.5 | 17.8 | 20.7 | 22.8 | 28.0 | 30.0 | 30.9 | |

Hearing Protection

Detectable ear plugs



SNR ^{dB} 23 S



minibox
2111261



2111262

uvex whisper detec

- easy-to-clean reusable corded earplugs
- smooth, dirt-repellent surface can be easily cleaned using mild soap and water
- earplug box for hygienic storage when not in use
- integrated metal parts and the blue colour ensure the earplugs can be detected in a production environment
- thanks to the cord, the earplugs are always conveniently to hand – in low-noise areas, the earplugs can be worn around the neck
- additional requirement: W, S

| uvex whisper detec | |
|--------------------|---|
| Art. no. | 2111261 2111262 |
| Design | with cord detectable, in minibox with cord detectable, in earplug box |
| Standard | EN 352-2 EN 352-2 |
| Colour | blue blue |
| Order unit | CT CT |
| Content | 50 PR, in pairs in CT 50 PR, in pairs in CT |

| SNR: 27 dB | H: 27 dB | M: 24 dB | L: 22 dB | | | | | | |
|------------|----------|----------|----------|------|------|------|------|------|--|
| f/Hz | 63 | 125 | 250 | 500 | 1000 | 2000 | 4000 | 8000 | |
| MA dB | 26.6 | 26.9 | 24.3 | 26.1 | 28.8 | 32.8 | 32.6 | 38.1 | |
| SD dB | 6.1 | 6.1 | 4.1 | 5.1 | 5.1 | 5.0 | 6.5 | 5.3 | |
| APV dB | 20.5 | 20.8 | 20.2 | 21.0 | 23.7 | 27.8 | 26.1 | 32.8 | |

SNR ^{dB} 27 M



minibox
2111260



2111239

uvex whisper+ detec

- easy-to-clean reusable corded earplugs
- smooth, dirt-repellent surface can be easily cleaned using mild soap and water
- earplug box for hygienic storage when not in use
- integrated metal parts and the blue colour ensure the earplugs can be detected in a production environment
- thanks to the cord, the earplugs are always conveniently to hand – in low-noise areas, the earplugs can be worn around the neck
- additional requirement: W, X, S, V, E₁

| uvex whisper+ detec | |
|---------------------|---|
| Art. no. | 2111260 2111239 |
| Design | with cord detectable, in minibox with cord detectable, in earplug box |
| Standard | EN 352-2 EN 352-2 |
| Colour | blue blue |
| Order unit | CT CT |
| Content | 50 PR, in pairs in CT 50 PR, in pairs in CT |

| SNR: 27 dB | H: 27 dB | M: 24 dB | L: 22 dB | | | | | | |
|------------|----------|----------|----------|------|------|------|------|------|--|
| f/Hz | 63 | 125 | 250 | 500 | 1000 | 2000 | 4000 | 8000 | |
| MA dB | 26.6 | 26.9 | 24.3 | 26.1 | 28.8 | 32.8 | 32.6 | 38.1 | |
| SD dB | 6.1 | 6.1 | 4.1 | 5.1 | 5.1 | 5.0 | 6.5 | 5.3 | |
| APV dB | 20.5 | 20.8 | 20.2 | 21.0 | 23.7 | 27.8 | 26.1 | 32.8 | |

MADE IN SWEDEN

Hearing Protection

Banded hearing protection

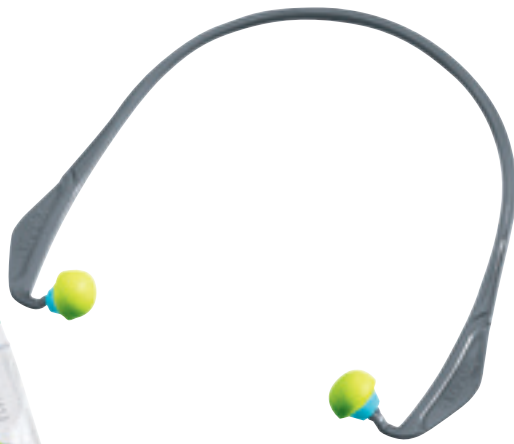

2125361

2125351

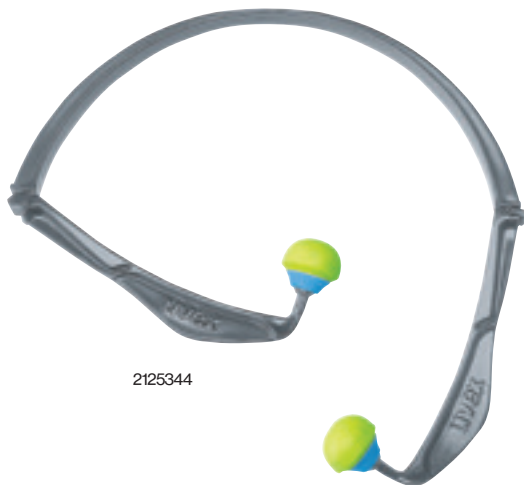

2125344



2125372

2124002
2124003

uvex x-cap

- ergonomically shaped banded ear protector for optimal positioning in front of the chin
- ergonomically shaped earplugs provide a high level of wearer comfort
- replaceable earplugs
- seal forms at the opening of the ear canal meaning there is no pressure in the ear
- additional requirement: W, E₃ (2125361)

| uvex x-cap | | |
|------------|----------------------------------|----------------------|
| Art. no. | 2125361 | 2125351 |
| Design | with band | replacement earplugs |
| Standard | EN 352-2 | |
| Colour | grey, sky blue, lime | sky blue, lime |
| Order unit | CT | CT |
| Content | 15 PC, individually packed in CT | 60 PR, CT of 5 pairs |

| SNR: 24 dB | H: 27 dB | M: 19 dB | L: 18 dB | | | | | |
|------------|----------|----------|----------|------|------|------|------|------|
| f/Hz | 63 | 125 | 250 | 500 | 1000 | 2000 | 4000 | 8000 |
| MA dB | 23.7 | 22.0 | 21.6 | 19.0 | 23.8 | 31.9 | 39.6 | 39.6 |
| SD dB | 4.0 | 2.9 | 4.7 | 4.3 | 3.6 | 4.0 | 2.7 | 3.7 |
| APV dB | 19.7 | 19.1 | 16.9 | 14.7 | 20.2 | 27.9 | 36.9 | 35.9 |

uvex x-fold

- ergonomically shaped banded ear protector for optimal positioning in front of the chin which eliminates noise transfer on contact
- ergonomically shaped replacement earplugs for optimal wearer comfort
- foldable banded ear protectors make storage easy

| uvex x-fold | | |
|-------------|---------------------------------|----------------------|
| Art. no. | 2125344 | 2125351 |
| Design | with foldable band | replacement earplugs |
| Standard | EN 352-2 | |
| Colour | grey, sky blue, lime | sky blue, lime |
| Order unit | CT | CT |
| Content | 5 PC, individually packed in CT | 60 PR, CT of 5 pairs |

| SNR: 23 dB | H: 26 dB | M: 18 dB | L: 17 dB | | | | | |
|------------|----------|----------|----------|------|------|------|------|------|
| f/Hz | 63 | 125 | 250 | 500 | 1000 | 2000 | 4000 | 8000 |
| MA dB | 24.2 | 23.8 | 20.5 | 18.5 | 21.6 | 31.3 | 36.3 | 39.4 |
| SD dB | 4.4 | 3.2 | 3.4 | 4.7 | 2.6 | 3.6 | 2.5 | 3.3 |
| APV dB | 19.7 | 20.6 | 17.1 | 13.8 | 19.0 | 27.8 | 33.9 | 36.1 |

uvex xact-band

- extremely low weight – just 4 grams
- seal forms inside the ear canal, just like disposable plugs
- integrated sound absorbers reduce noise transmission through the band
- replacement earplugs can be dispensed through the standard uvex wall mounted dispenser unit
- banded ear protector
- thumb indentations on the stems for quick and easy fitting

| uvex xact-band | | | |
|----------------|---------------------------------|-----------------------|----------------------|
| Art. no. | 2125372 | 2124002 | 2124003 |
| Design | with band | replacement earplugs | replacement earplugs |
| Standard | EN 352-2 | | |
| Colour | grey, sky-blue, lime | lime | lime |
| Order unit | CT | CT | CT |
| Content | 5 PC, individually packed in CT | 250 PR, CT of 5 pairs | 400 PR, loose in CT |

| SNR: 26 dB | H: 29 dB | M: 22 dB | L: 21 dB | | | | | |
|------------|----------|----------|----------|------|------|------|------|------|
| f/Hz | 63 | 125 | 250 | 500 | 1000 | 2000 | 4000 | 8000 |
| MA dB | 21.5 | 23.3 | 24.7 | 25.3 | 27.1 | 33.0 | 37.3 | 38.5 |
| SD dB | 3.6 | 3.6 | 4.7 | 6.0 | 5.5 | 2.7 | 4.3 | 4.9 |
| APV dB | 17.9 | 19.7 | 20.0 | 19.3 | 21.5 | 30.3 | 33.0 | 33.6 |

Hearing Protection

K series · Features



Padded headbands for optimum wearer comfort.

Low weight noticeably increases wearing comfort.

Colour coding
An easy to understand traffic light system supports correct product selection.

uvex K series



Length adjustment
Easily adjustable for a perfect fit and optimum protection.



Padded headband
Padded headband for optimum comfort, when worn for long periods.



Memory foam
Wearer comfort guaranteed thanks to extra soft memory foam ear cushions, even when worn for long periods.



Extremely light weight
Ultra low weight makes them comfortable even when worn for extended periods.



Certification
Certified in accordance with EN 352-1, Australian Standard AS/NZS and ANSI.



Dielectric
Metal-free earmuffs suitable for use in workplace environments with exposure to electrical voltage.

Accessories



Replacement pads
Replacement pads for lasting comfort and hygienic use.

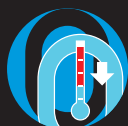

Comfort pads
Self-adhesive comfort pads for maximum comfort, including higher temperature environments.

uvex K200



Length adjustment
Easily adjustable for a customised fit and optimum protection.



Optimum fit
Adjustable headband delivers individual fit and customised protection.



360° rotation
Range of positions possible with 360° capsule rotation. Earmuffs with a headband can be worn under the chin or around the neck.



Dielectric
Metal-free earmuffs suitable for use in workplace environments with exposure to electrical voltage.

uvex K1H · uvex K2H · uvex K1P · uvex K2P



Length adjustment
Easily adjustable for a customised fit to ensure optimum protection.



Resting position
Earmuffs can be rotated 360° for easy use from standby and resting positions.



Helmet-visor combination
uvex earmuffs can be combined with uvex safety helmets to ensure complete all-round head protection.

Hearing Protection Earmuffs



2600001



uvex K1

- ear muffs with length adjustment
- lightweight with a small cup
- easily adjustable for a perfect fit
- soft surface and padded headband for optimum wearer comfort

| | |
|-------------------|---------------|
| uvex K1 | |
| Art. no. | 2600001 |
| Design | with headband |
| Standard | EN 352-1 |
| Weight | 180 g |
| Colour | black, green |
| Order unit | PC |

| SNR: 28 dB | H: 35 dB | M: 24 dB | L: 17 dB | | | | |
|------------|----------|----------|----------|------|------|------|------|
| f/Hz | 125 | 250 | 500 | 1000 | 2000 | 4000 | 8000 |
| MA dB | 17.6 | 16.3 | 25.4 | 34.5 | 37.7 | 39.9 | 41.7 |
| SD dB | 3.9 | 3.1 | 2.8 | 3.2 | 3.2 | 3.5 | 3.6 |
| APV dB | 13.7 | 13.2 | 22.6 | 31.3 | 34.4 | 36.4 | 38.1 |



2600002



uvex K2

- earmuffs with length adjustment
- lightweight with a small cup
- easily adjustable for a perfect fit
- padded headband for optimum wearer comfort
- wearer comfort guaranteed thanks to extra-soft memory foam ear cushions, especially when worn for long periods

| | |
|-------------------|---------------|
| uvex K2 | |
| Art. no. | 2600002 |
| Design | with headband |
| Standard | EN 352-1 |
| Weight | 217 g |
| Colour | black, yellow |
| Order unit | PC |

| SNR: 32 dB | H: 37 dB | M: 29 dB | L: 21 dB | | | | |
|------------|----------|----------|----------|------|------|------|------|
| f/Hz | 125 | 250 | 500 | 1000 | 2000 | 4000 | 8000 |
| MA dB | 21.0 | 20.7 | 29.8 | 38.6 | 39.0 | 43.8 | 42.8 |
| SD dB | 4.5 | 3.1 | 2.8 | 2.7 | 3.2 | 4.3 | 4.0 |
| APV dB | 16.5 | 17.7 | 27.0 | 35.8 | 35.8 | 39.4 | 38.7 |



2600012



uvex K2 foldable

- Dielectric earmuffs with length adjustment and foldable headband
- Lightweight with a small cup
- Extra-soft memory foam ear cushions for wearer comfort
- Hi-vis design for improved wearer visibility

| | |
|-------------------|------------------------|
| uvex K2 foldable | |
| Art. no. | 2600012 |
| Design | with foldable headband |
| Standard | EN 352-1 |
| Weight | 229 g |
| Colour | neon lime |
| Order unit | PC |

| SNR: 31 dB | H: 35 dB | M: 29 dB | L: 21 dB | | | | |
|------------|----------|----------|----------|------|------|------|------|
| f/Hz | 125 | 250 | 500 | 1000 | 2000 | 4000 | 8000 |
| MA dB | 16.2 | 20.5 | 30.5 | 39.5 | 35.3 | 36.3 | 39.7 |
| SD dB | 2.4 | 2.0 | 1.8 | 2.3 | 1.4 | 2.7 | 2.7 |
| APV dB | 13.8 | 18.5 | 28.6 | 37.2 | 33.9 | 33.6 | 37.1 |

Hearing Protection

Earmuffs



2600003



uvex K3

- earmuffs with length adjustment
- lightweight with a small cup
- higher protection levels in high-frequency range
- easily adjustable for a perfect fit
- padded headband for optimum wearer comfort
- wearer comfort guaranteed thanks to extra-soft memory foam ear cushions, even when worn for long periods

| | |
|-------------------|---------------|
| uvex K3 | |
| Art. no. | 2600003 |
| Design | with headband |
| Standard | EN 352-1 |
| Weight | 297 g |
| Colour | black, red |
| Order unit | PC |

| SNR: 33 dB | H: 36 dB | M: 30 dB | L: 22 dB | | | | |
|------------|----------|----------|----------|------|------|------|------|
| f/Hz | 125 | 250 | 500 | 1000 | 2000 | 4000 | 8000 |
| MA dB | 19.2 | 21.7 | 32.4 | 39.4 | 37.3 | 39.1 | 40.7 |
| SD dB | 2.7 | 2.2 | 3.0 | 3.3 | 3.0 | 3.1 | 3.8 |
| APV dB | 16.5 | 19.5 | 29.4 | 36.1 | 34.3 | 36.0 | 36.9 |



2600004



uvex K4

- optimum protection in extremely noisy environments
- easy length adjustment and optimised headband padding for exceptional wearer comfort
- hi-vis design for improved wearer visibility
- wearer comfort guaranteed thanks to extra-soft memory foam ear cushions, even when worn for long periods

| | |
|-------------------|---------------|
| uvex K4 | |
| Art. no. | 2600004 |
| Design | with headband |
| Standard | EN 352-1 |
| Weight | 356 g |
| Colour | neon lime |
| Order unit | PC |

| SNR: 35 dB | H: 38 dB | M: 33 dB | L: 24 dB | | | | |
|------------|----------|----------|----------|------|------|------|------|
| f/Hz | 125 | 250 | 500 | 1000 | 2000 | 4000 | 8000 |
| MA dB | 20.2 | 24.6 | 35.5 | 41.5 | 38.4 | 42.1 | 45.0 |
| SD dB | 3.0 | 1.8 | 2.6 | 2.3 | 2.7 | 3.5 | 2.8 |
| APV dB | 17.2 | 22.8 | 32.9 | 39.2 | 35.7 | 38.6 | 42.2 |



2600200



uvex K200

- dielectric ear muffs with length adjustment
- suitable for use in workplace environments with exposure to electrical voltage
- adjustable headband for a perfect fit and optimum protection
- easily adjustable for a customised fit
- range of positions possible with 360° capsule rotation

| | |
|-------------------|--------------------|
| uvex K200 | |
| Art. no. | 2600200 |
| Design | with 360° headband |
| | rotatable |
| Standard | EN 352-1 |
| Weight | 173 g |
| Colour | black, ochre |
| Order unit | PC |

| SNR: 28 dB | H: 33 dB | M: 25 dB | L: 18 dB | | | | |
|------------|----------|----------|----------|------|------|------|------|
| f/Hz | 125 | 250 | 500 | 1000 | 2000 | 4000 | 8000 |
| MA dB | 16.4 | 18.4 | 25.7 | 33.0 | 35.9 | 39.4 | 41.9 |
| SD dB | 3.4 | 3.7 | 2.8 | 3.5 | 3.7 | 4.4 | 4.1 |
| APV dB | 13.0 | 14.6 | 23.0 | 29.5 | 32.2 | 35.0 | 37.8 |

Hearing Protection Earmuffs

SNR
dB
29



2600000



2600010



2600011



2600013



uvex K Junior

- earmuffs with shorter headband
- suitable for head widths up to 145 mm, equivalent to sizes S/M
- padded headband and soft cushions for optimum wearer comfort

| uvex K Junior | | | | |
|-------------------|-----------------------|-----------------------|-----------------------|-----------------------|
| Art. no. | 2600000 | 2600010 | 2600011 | 2600013 |
| Design | with shorter headband | with shorter headband | with shorter headband | with shorter headband |
| Standard | EN 352-1 | EN 352-1 | EN 352-1 | EN 352-1 |
| Weight | 173 g | 173 g | 173 g | 173 g |
| Colour | yellow | blue | lime | pink |
| Order unit | PC | PC | PC | PC |

| SNR: 29 dB | H: 34 dB | M: 29 dB | L: 21 dB | | | | | | |
|------------|----------|----------|----------|------|------|------|------|------|--|
| f/Hz | | 125 | 250 | 500 | 1000 | 2000 | 4000 | 8000 | |
| MA dB | | 15.9 | 17.0 | 27.2 | 37.0 | 34.5 | 39.9 | 39.1 | |
| SD dB | | 3.6 | 2.4 | 2.7 | 3.3 | 3.3 | 3.1 | 3.6 | |
| APV dB | | 12.3 | 14.6 | 24.5 | 34.0 | 31.2 | 36.8 | 35.6 | |

Hearing Protection

Helmet earmuffs



2600201

SNR
dB
27



2600202

SNR
dB
30



uvex K1H

- for helmets with 30-mm Euroslot
- not compatible with the uvex pheos visor system
- length is easily adjustable for a perfect fit on the helmet
- soft ear cushions adapt to surface and head shape to ensure optimum wearer comfort
- 360° rotation for standby and resting positions

| | |
|------------|------------------------------------|
| uvex K1H | |
| Art. no. | 2600201 |
| Design | helmet earmuffs for 30-mm Euroslot |
| Standard | EN 352-3 |
| Weight | 210 g |
| Colour | black, green |
| Order unit | PR |

| | | | | | | | |
|------------|----------|----------|----------|------|------|------|------|
| SNR: 27 dB | H: 32 dB | M: 24 dB | L: 17 dB | | | | |
| f/Hz | 125 | 250 | 500 | 1000 | 2000 | 4000 | 8000 |
| MA dB | 15.0 | 15.3 | 23.5 | 31.8 | 34.3 | 37.3 | 38.4 |
| SD dB | 2.8 | 2.0 | 2.3 | 3.0 | 2.7 | 3.5 | 3.3 |
| APV dB | 12.2 | 13.2 | 21.2 | 28.8 | 31.6 | 33.7 | 35.0 |

uvex K2H

- for helmets with 30-mm Euroslot
- not compatible with the uvex pheos visor system
- length is easily adjustable for a perfect fit on the helmet
- wearer comfort guaranteed thanks to extra-soft memory foam ear cushions, even when worn for long periods
- 360° rotation for standby and resting positions

| | |
|------------|------------------------------------|
| uvex K2H | |
| Art. no. | 2600202 |
| Design | helmet earmuffs for 30-mm Euroslot |
| Standard | EN 352-3 |
| Weight | 251 g |
| Colour | black, yellow |
| Order unit | PR |

| | | | | | | | |
|------------|----------|----------|----------|------|------|------|------|
| SNR: 30 dB | H: 35 dB | M: 27 dB | L: 20 dB | | | | |
| f/Hz | 125 | 250 | 500 | 1000 | 2000 | 4000 | 8000 |
| MA dB | 17.9 | 19.3 | 27.1 | 34.6 | 36.5 | 39.5 | 40.1 |
| SD dB | 2.8 | 2.4 | 3.0 | 3.1 | 2.8 | 2.7 | 3.5 |
| APV dB | 15.1 | 16.8 | 24.1 | 31.4 | 33.7 | 36.8 | 36.6 |

Combination options

Compatible with the following products:

uvex industrial safety helmets uvex pheos ABS, uvex pheos B, uvex pheos B-WR, uvex pheos B-S-WR, uvex pheos IES, uvex pheos alpine, uvex airwing, uvex super boss (page 106 onwards) together with the K1H or K2H helmet earmuffs (page 97) and the 9790 visor (page 129)



all uvex pheos models except uvex pheos E, as it is not dielectric



uvex pheos alpine



uvex airwing



uvex superboss

Hearing Protection

uvex pheos helmet system

Adapts perfectly to your requirements – thanks to the flexible modular system.



Every detail of the new pheos helmet system has been carefully thought through to deliver an advanced head protection solution. The magnetic locking system makes it simple to attach the visor and ear muffs, while the ergonomic joint system makes it extremely comfortable to wear for long periods.



Magnetic lock system
for visor and ear muffs

One click attachment system

The unique magnetic lock system allows parts to connect easily – the helmet does not need to be removed when attaching or removing the ear muffs.

Extra-soft ear muffs

Wearer comfort guaranteed thanks to extra-soft memory foam ear cushions, even when worn for long periods.

Hearing Protection

uvex pheos helmet earmuffs



SNR
dB
28



2600216

(Conformity assessment not yet completed)



uvex pheos K2P
bayonet connection



uvex pheos K2P
magnetic connection

SNR
dB
30



2600214
2600215



uvex pheos K1P · uvex pheos K2P

- Wearer comfort guaranteed thanks to extra-soft memory foam ear cushions, even when worn for long periods
- 360° rotation for standby and resting positions
- Helmet earmuffs can only be used with uvex pheos visors
- available as a bayonet variant so it can be attached and removed quickly and easily without tools

- available as a magnetic variant so the earmuffs can be quickly and easily attached and removed without having to take off the helmet
- easy, convenient height adjustment of earmuffs
- dielectric

uvex pheos K1P

| | |
|-------------------|--------------------|
| Art. no. | 2600216 |
| Design | bayonet connection |
| Standard | EN 352-3 |
| Weight | 191 g |
| Colour | black, grey |
| Order unit | PR |

uvex pheos K1P bayonet connection:

| SNR: 28 dB | H: 34 dB | M: 25 dB | L: 18 dB | | | | | |
|------------|----------|----------|----------|------|------|------|------|--|
| f/Hz | 125 | 250 | 500 | 1000 | 2000 | 4000 | 8000 | |
| MA dB | 14.2 | 17.5 | 24.3 | 32.9 | 37.5 | 37.3 | 38.3 | |
| SD dB | 2.4 | 2.6 | 3.1 | 3.1 | 3.2 | 3 | 2.7 | |
| APV dB | 11.8 | 14.9 | 21.3 | 29.8 | 34.3 | 34.3 | 35.5 | |

uvex pheos K2P

| | | |
|-------------------|--------------------|---------------------|
| Art. no. | 2600214 | 2600215 |
| Design | bayonet connection | magnetic connection |
| Standard | EN 352-3 | EN 352-3 |
| Weight | 235 g | 240 g |
| Colour | black, yellow | black, yellow |
| Order unit | PR | PR |

uvex pheos K2P bayonet connection:

| SNR: 30 dB | H: 35 dB | M: 27 dB | L: 20 dB | | | | | |
|------------|----------|----------|----------|------|------|------|------|--|
| f/Hz | 125 | 250 | 500 | 1000 | 2000 | 4000 | 8000 | |
| MA dB | 16.1 | 20 | 26.9 | 35.9 | 37.8 | 39.2 | 39.7 | |
| SD dB | 2.2 | 2.6 | 3.2 | 4 | 3.7 | 3.7 | 3.2 | |
| APV dB | 13.9 | 17.4 | 23.8 | 31.8 | 34 | 35.5 | 36.5 | |

uvex pheos K2P magnetic connection:

| SNR: 30 dB | H: 35 dB | M: 27 dB | L: 20 dB | | | | | |
|------------|----------|----------|----------|------|------|------|------|--|
| f/Hz | 125 | 250 | 500 | 1000 | 2000 | 4000 | 8000 | |
| MA dB | 16.2 | 20.1 | 26.9 | 35.4 | 37.0 | 39.2 | 41.0 | |
| SD dB | 1.8 | 3.3 | 3.5 | 3.4 | 3.0 | 4.1 | 2.6 | |
| APV dB | 14.4 | 16.8 | 23.4 | 32.0 | 33.9 | 35.2 | 38.4 | |

Magnetic helmet adapter

| | |
|-------------------|---|
| Art. no. | 9790078 |
| Design | helmet adapter for magnetic helmet earmuffs |
| Order unit | PR |

The adapter can be retrofitted to a helmet at any time via the 30-mm Euroslot. The adapter only fits uvex pheos and uvex pheos alpine helmets.



9790078

Hearing Protection Accessories



6177116



211404



2134000



2599971
2599972



2599978



2000002

uvex clear otoplastics

- silicone-free towelettes for quick and easy cleaning of reusable ear plugs

| | |
|------------------------|----------------------|
| uvex clear otoplastics | |
| Art. no. | 6177116 |
| Content | 30 towelettes per PC |
| Order unit | PC |

uvex earplug box

- box for hygienic earplug storage
- compact and dirt-resistant design
- for one pair of reusable earplugs with cord
- or two pairs of reusable earplugs without cord

| | |
|-------------------|-----------------------|
| uvex earplug box | |
| Art. no. | 211404 |
| Design | earplugs not included |
| Colour | transparent |
| Content | 50 PC per Box |
| Order unit | CT |

Wall bracket for dispenser box

- plexiglas wall-mounted dispenser, suitable for uvex x-fit (2112001, 2112010, 2112011), uvex com4-fit (2112004, 2112012), uvex one-fit (2112045), uvex xtra-fit (2112060), uvex hi-com (2112100, 2112101, 2112106, 2112114).

| | |
|--------------------------------|-------------|
| Wall bracket for dispenser box | |
| Art. no. | 2134000 |
| Material | PMMA |
| Colour | transparent |
| Order unit | PC |

uvex K Series - Hygiene kits

| | | |
|-------------------|---|--|
| | uvex K series hygienekit standard | uvex K series hygienekit-premium |
| Art. no. | 2599971 | 2599972 |
| Design | accessories for uvex K1, uvex K1H, uvex K1P, uvex K200, uvex K junior | accessories for uvex K2, uvex K2 folable, uvex K2H, uvex K2P, uvex K3, uvex K4 |
| Content | 2 ear pads and 2 muffling pads | 2 ear pads and 2 muffling pads |
| | in BG | in BG |
| Order unit | BG | BG |

uvex K series comfort pads "uvex dry pads"

- accessories for all models in the uvex K series
- the comfort pads can be attached to the sealing cushions to absorb moisture and sweat

| | |
|--|---|
| uvex K series comfort pads "uvex dry pads" | |
| Art. no. | 2599978 |
| Design | self-adhesive, suitable for all models in the uvex K series |
| Content | 10 Pads in BG |
| Order unit | BG |

uvex earmuff bag

| | |
|-------------------|---|
| uvex earmuff bag | |
| Art. no. | 2000002 |
| Design | with belt loop and hook-and-loop fastener |
| Order unit | PC |

Hearing protection

Marketing material



Hearing protection guide

- 25 pages
- with Euro holes
- includes all essential information about hearing protection
- art. no.: 1001.214 (German)
- art. no.: 1001.215 (English)



Hearing protection tester box

Find the perfect hearing protection for you:

- box containing selection of uvex disposable/ reusable and detectable hearing protection earplugs plus uvex xact-band banded ear protectors
- article number: 1000929



Sample case for ear-plugs

- empty, with six compartments for earmuffs
- art. no.: 2599966



Usage poster

- Article numbers
- 1001.165 (German)
 - 1001.166 (English)
 - Size: A2



uvex Decibel app

- free from the App Store

Hearing Protection

Overview

| Art. no. | Name | Product | Colour | Content | Page |
|----------|----------------------------------|---|----------------------|--------------------------------------|-------|
| 2000002 | | Earmuff bag | | PC | 100 |
| 2111201 | uvex whisper | Reusable earplugs with cord in a mini box | orange | 50 PR, in pairs in CT | 89 |
| 2111212 | uvex whisper+ | Reusable earplugs with cord in a mini box | lime | 50 PR, in pairs in CT | 89 |
| 2111235 | uvex whisper supreme | Reusable earplugs with cord in earplug box | yellow | 50 PR, in pairs in CT | 89 |
| 2111237 | uvex whisper | Reusable earplugs with cord in earplug box | orange | 50 PR, in pairs in CT | 89 |
| 2111239 | uvex whisper+ detec | Detectable reusable earplugs with cord in earplug box | blue | 50 PR, in pairs in CT | 91 |
| 2111260 | uvex whisper+ detec | Reusable earplugs with cord in a mini box | | 50 PR, in pairs in CT | 91 |
| 2111261 | uvex whisper detec | Reusable earplugs with cord in a mini box | | 50 PR, in pairs in CT | 91 |
| 2111262 | uvex whisper detec | Reusable earplugs with cord in a mini box | | 50 PR, in pairs in CT | 91 |
| 2111404 | | uvex earplug box | transparent | CT | 100 |
| 2111988 | one 2 click | dispenser, empty, magnetic | | CT | 86 |
| 2111989 | | Magnetic wall bracket for dispenser | | CT | 86 |
| 2111990 | one 2 click | Dispenser filled with 600 pairs of x-fit earplugs | | 600 PR, x-fit | 86 |
| 2111991 | one 2 click | Dispenser filled with 600 pairs of com4-fit earplugs | | 600 PR, xcom4-fit | 86 |
| 2111992 | one 2 click | Dispenser filled with 600 pairs of hi-com earplugs | | 600 PR, hi-com | 86 |
| 2112000 | one 2 click | Dispenser for 600 pairs of earplugs, empty | | CT | 86 |
| 2112001 | uvex x-fit | Disposable earplugs without cord | lime | 200 PR, packed in pairs in CT | 85 |
| 2112004 | uvex com4-fit | Disposable earplugs without cord | light orange | 200 PR, packed in pairs in CT | 85 |
| 2112010 | uvex x-fit | Disposable earplugs with cord | lime | 100 PR, packed in pairs in CT | 85 |
| 2112011 | uvex x-fit detec | Detectable disposable earplugs with cord | blue | 100 PR, in pairs in CT | 90 |
| 2112012 | uvex com4-fit | Disposable earplugs with cord | light orange | 100 PR, packed in pairs in CT | 85 |
| 2112013 | uvex x-fit | Disposable earplugs without cord | | 50 PR, loose in CT | 85 |
| 2112022 | uvex x-fit | Refill box | lime | 300 PR, loose in CT | 86 |
| 2112023 | uvex com4-fit | Refill box | light orange | 300 PR, loose in CT | 86 |
| 2112060 | uvex xtra-fit | Disposable earplugs without cord | orange | 200 PR, packed in pairs in BG | 85 |
| 2112061 | uvex xtra-fit | Refill box | orange | 250 PR, loose in BG | 86 |
| 2112093 | uvex xtra-fit | Minidispenser Box | orange | 100 PR, packed in pairs in CT | 85 |
| 2112094 | uvex x-fit | Minidispenser Box | lime | 100 PR, packed in pairs in CT | 85 |
| 2112095 | uvex hi-com | Minidispenser Box | lime | 100 PR, packed in pairs in CT | 84 |
| 2112096 | uvex com4-fit | Minidispenser Box | light orange | 100 PR, packed in pairs in CT | 85 |
| 2112100 | uvex hi-com | Disposable earplugs without cord | lime | 200 PR, packed in pairs in CT | 84 |
| 2112101 | uvex hi-com | Disposable earplugs with cord | lime | 100 PR, packed in pairs in CT | 84 |
| 2112106 | uvex hi-com | Disposable earplugs without cord | beige | 200 PR, packed in pairs in CT | 84 |
| 2112114 | uvex hi-com detec | Detectable disposable earplugs with cord | blue | 100 PR, in pairs in CT | 90 |
| 2112118 | uvex hi-com | Refill box | lime | 300 PR, loose in CT | 86 |
| 2112119 | uvex hi-com | Refill box | beige | 300 PR, loose in CT | 86 |
| 2112131 | uvex com4-fit | Refill box | light orange | 15 PR, loose in CT | 85 |
| 2112133 | uvex x-fit | Disposable earplugs without cord | | 15 PR, loose in CT | 85 |
| 2124001 | uvex xact-fit | Earplugs with cord and pin | lime, grey | 50 PR, packed in pairs in CT | 88 |
| 2124002 | uvex xact-fit | Replacement earplugs | lime | 250 PR, CT of 5 pairs | 88/92 |
| 2124003 | uvex xact-fit | Refill box | lime | 400 PR, loose in CT | 88/92 |
| 2124011 | uvex xact-fit detec | Detectable earplugs with pin | blue | 50 PR, in pairs in CT | 90 |
| 2124013 | uvex xact-fit detec | Refill box | blue | 400 PR, loose in CT | 90 |
| 2124017 | uvex xact-fit multi reusable S | Reusable earplugs with oval-shaped reusable plugs | grey, transparent | 50 PR, packed in pairs in CT | 88 |
| 2124018 | uvex xact-fit multi reusable M/L | Reusable earplugs with oval-shaped reusable plugs | grey, transparent | 50 PR, packed in pairs in CT | 88 |
| 2124019 | uvex xact-fit multi reusable S | Reusable earplugs with oval-shaped reusable plugs | grey, transparent | 50 PR, packed in pairs in CT | 88 |
| 2124020 | uvex xact-fit multi reusable M/L | Reusable earplugs with oval-shaped reusable plugs | grey, transparent | 50 PR, packed in pairs in CT | 88 |
| 2125344 | uvex x-fold | Folding banded ear protector | grey, sky blue, lime | 5 PC, individually packed in CT | 92 |
| 2125351 | | Replacement earplugs for uvex x-cap and uvex x-fold | sky blue, lime | 60 PR, CT of 5 pairs | 92 |
| 2125361 | uvex x-cap | Banded ear protector | grey, sky blue, lime | 15 PC, individually packed in CT | 92 |
| 2125372 | uvex xact-band | Banded ear protector | grey, sky blue, lime | 5 PC, individually packed in CT | 92 |
| 2134000 | | Wall-mounted dispenser | | PC | 100 |
| 2599971 | | Hygiene kit uvex K series standard | | 2 ear pads and 2 muffling pads in BG | 100 |
| 2599972 | | Hygiene kit uvex K series premium | | 2 ear pads and 2 muffling pads in BG | 100 |
| 2599978 | | Comfort pads | | 10 Pads in BTL | 100 |
| 2600000 | uvex K junior | Passive earmuffs | yellow, black | PC | 96 |
| 2600001 | uvex K1 | Passive earmuffs | black, green | PC | 94 |
| 2600002 | uvex K2 | Passive earmuffs | black, yellow | PC | 94 |
| 2600003 | uvex K3 | Passive earmuffs | black, red | PC | 95 |
| 2600004 | uvex K4 | Passive earmuffs | neon lime | PC | 95 |
| 2600010 | uvex K junior | Passive earmuffs | blue | PC | 96 |
| 2600011 | uvex K junior | Passive earmuffs | lime | PC | 96 |
| 2600012 | uvex K2 foldable | Passive earmuffs | neon lime | PC | 94 |
| 2600013 | uvex K junior | Passive earmuffs | pink | PC | 96 |
| 2600200 | uvex K200 | Passive earmuffs | black, ochre | PC | 95 |
| 2600201 | uvex K1H | Earmuffs with helmet attachment | black, green | PR | 97 |
| 2600202 | uvex K2H | Earmuffs with helmet attachment | black, yellow | PR | 97 |
| 2600214 | uvex pheos K2P | Earmuffs with helmet attachment | black, yellow | PR | 99 |
| 2600215 | uvex pheos K2P | Earmuffs with helmet attachment | black, yellow | PR | 99 |
| 2600216 | uvex pheos K1P | Earmuffs with helmet attachment | black, green | PR | 99 |
| 6177116 | uvex clear otoplastics | silicone-free towelettes | | 30 towelettes, PC | 100 |
| 9790078 | | Helmet adapter | black | PR | 99 |



Safety Helmets

Standards at a glance

EN 397 · EN 50365

EN 397 – Industrial safety helmets

Protection against falling objects and the consequences thereof, such as brain damage and skull fracture

Binding requirements: all helmets certified according to EN 397 must meet these requirements.

- shock absorption, vertical
- penetration resistance (against sharp and pointed objects)
- flame resistance
- chin strap attachment: chin strap releases at minimum 150 N and maximum 250 N

Optional requirements: a helmet certified in accordance with EN 397 may meet these requirements; they are, however, not mandatory requirements.

- very low temperatures (-20°C or -30°C)
- very high temperatures (+150°C)
- electrical insulation (440 V)
- molten metal (MM)
- lateral deformation

| | | | | | |
|--|---|---|---|--|---|
| very low temperatures (-20°C or -30°C) |  uvex airwing |  uvex super boss |  uvex pheos |  uvex pheos alpine | |
| very high temperatures (+150°C) | | | | |  uvex thermo boss |
| electrical insulation (440 V) | |  uvex airwing E | | |  uvex thermo boss |
| molten metal (MM) | | |  uvex pheos | | |
| lateral deformation | | | | | |

EN 50365 – Insulating helmets for use on low voltage installations

Protection against electric shocks and prevention of dangerous electric current passing through the head

Requirements:

- All helmets must also meet the requirements in accordance with EN 397.
- Protection against alternating voltage of up to 1000 V (AC) or direct voltage up to 1500 V (DC)
- Insulating helmets must not contain any conductive parts.
- Air vents (if available) must not allow any accidental contact with live parts.



uvex pheos E

Overview of standards

EN 12492

EN 12492 – Helmets for mountaineers

Protection against hazards that may occur during activities undertaken by mountaineers

Requirements:

- Shock absorption, vertical, frontal, lateral, dorsal
- Penetration resistance
- Carrier element (chin strap releases at min. 500 N)
- Strength of carrier element: Chin strap may exhibit maximum elongation of 25 mm
- Carrier element effectiveness: Helmet must not slide from the head



uvex pheos alpine



uvex pheos IES

IES ensures eyewear is always where it should be.

When combining helmets and safety eyewear, the position of the eyewear is related to that of the helmet shell. If the helmet shifts as a result of sudden movement, this inevitably means the visor moves, which can be dangerous as it changes light conditions.

IES stands for Integrated Eyewear System and the name says it all:

With this system, uvex pheos safety spectacles can be pushed up inside the uvex pheos helmet or pulled down to sit on the nose. The sliding element can be swiveled, so that the helmet can move, while the eyewear keeps its position.



Integrated Eyewear System

The nose piece of uvex pheos / pheos s / i-woks safety spectacles is clicked into the mount and locked into the sliding element in the interior of the helmet.



Functionality uvex pheos IES

The spectacles have a set storage spot in the helmet. If safety eyewear is required, it can be pulled down quickly and easily.



uvex pheos IES

- safety helmet with slots for uvex visors, earmuffs, lamps and Integrated Eyewear System (IES)
- side Euroslot adapters (30 mm) for attaching earmuffs
- meets standard EN 397 and additional requirements for very low temperatures (-30 °C) and molten metal (MM) splash
- three variable air vents for maximum ventilation
- suspension harness with wheel ratchet for variable width adjustment – also has the option to mount uvex pheos, uvex pheos or uvex i-woks safety spectacles
- fitted with the 9760007 sweatband
- six-point textile band attachment ensures optimal fit and comfort

| uvex pheos IES with wheel ratchet system | | | | | |
|--|----------------|--------------|--------------|--------------|--------------|
| Art. no. | 9772040 | 9772140 | 9772240 | 9772340 | 9772540 |
| Colour | white | yellow | orange | red | blue |
| Version | with long brim | | | | |
| Material | HDPE | HDPE | HDPE | HDPE | HDPE |
| Standard | EN 397 | EN 397 | EN 397 | EN 397 | EN 397 |
| | -30 °C, MM | -30 °C, MM | -30 °C, MM | -30 °C, MM | -30 °C, MM |
| Sizes | 55 to 61 cm | 55 to 61 cm | 55 to 61 cm | 55 to 61 cm | 55 to 61 cm |
| Order unit | PC | PC | PC | PC | PC |
| Outer packaging | 25 PC per CT | 25 PC per CT | 25 PC per CT | 25 PC per CT | 25 PC per CT |

MADE IN GERMANY



Safety Helmets

uvex pheos B · uvex pheos B-WR · uvex pheos B-S-WR



uvex pheos B · uvex pheos B-WR

- safety helmet with slots for uvex visors, earmuffs and lamps
- side Euroslot adapters (30 mm) for attaching earmuffs
- meets standard EN 397 and additional requirements for very low temperatures (-30 °C) and molten metal (MM) splash
- three variable air vents for maximum ventilation
- conventional suspension harness for comfortable adjustable fit (uvex pheos B)
- suspension harness with wheel ratchet for variable width adjustment (uvex pheos B-WR)
- fitted with the 9760005 sweatband
- six-point textile band attachment ensures optimal fit and comfort

| uvex pheos B with conventional suspension harness | | | | | | |
|---|----------------|--------------|--------------|--------------|--------------|--------------|
| Art. no. | 9772020 | 9772120 | 9772220 | 9772320 | 9772520 | 9772920 |
| Colour | white | yellow | orange | red | blue | black |
| Version | with long brim | | | | | |
| Material | HDPE | HDPE | HDPE | HDPE | HDPE | HDPE |
| Standard | EN 397 | EN 397 | EN 397 | EN 397 | EN 397 | EN 397 |
| | -30 °C, MM | -30 °C, MM | -30 °C, MM | -30 °C, MM | -30 °C, MM | -30 °C, MM |
| Sizes | 51 to 61 cm | 51 to 61 cm | 51 to 61 cm | 51 to 61 cm | 51 to 61 cm | 51 to 61 cm |
| Order unit | PC | PC | PC | PC | PC | PC |
| Outer packaging | 25 PC per CT | 25 PC per CT | 25 PC per CT | 25 PC per CT | 25 PC per CT | 25 PC per CT |

| uvex pheos B-WR with wheel ratchet system | | | | | | | |
|---|----------------|----------------|----------------|----------------|----------------|----------------|----------------|
| Art. no. | 9772030 | 9772130 | 9772230 | 9772330 | 9772430 | 9772530 | 9772930 |
| Colour | white | yellow | orange | red | green | blue | black |
| Version | with long brim | with long brim | with long brim | with long brim | with long brim | with long brim | with long brim |
| Material | HDPE | HDPE | HDPE | HDPE | HDPE | HDPE | HDPE |
| Standard | EN 397 | EN 397 | EN 397 | EN 397 | EN 397 | EN 397 | EN 397 |
| | -30 °C, MM | -30 °C, MM | -30 °C, MM | -30 °C, MM | -30 °C, MM | -30 °C, MM | -30 °C, MM |
| Sizes | 52 to 61 cm | 52 to 61 cm | 52 to 61 cm | 52 to 61 cm | 52 to 61 cm | 52 to 61 cm | 52 to 61 cm |
| Order unit | PC | PC | PC | PC | PC | PC | PC |
| Outer packaging | 25 PC per CT | 25 PC per CT | 25 PC per CT | 25 PC per CT | 25 PC per CT | 25 PC per CT | 25 PC per CT |



uvex pheos B-S-WR

- safety helmet with slots for uvex visors, earmuffs and lamps
- side Euroslot adapters (30 mm) for attaching earmuffs
- meets standard EN 397 and additional requirements for very low temperatures (-30 °C) and molten metal (MM) splash
- three variable air vents for maximum ventilation
- suspension harness with wheel ratchet for variable width adjustment
- fitted with the 9760005 sweatband
- shorter brim for a wider field of upward vision
- six-point textile band attachment ensures optimal fit and comfort

| uvex pheos B-S-WR with wheel ratchet system | | | | | | | |
|---|-----------------|-----------------|-----------------|-----------------|-----------------|-----------------|-----------------|
| Art. no. | 9772031 | 9772131 | 9772231 | 9772332 | 9772531 | 9772832 | 9772932 |
| Colour | white | yellow | orange | red | blue | dark grey | black |
| Version | with short brim | with short brim | with short brim | with short brim | with short brim | with short brim | with short brim |
| Material | HDPE | HDPE | HDPE | HDPE | HDPE | HDPE | HDPE |
| Standard | EN 397 | EN 397 | EN 397 | EN 397 | EN 397 | EN 397 | EN 397 |
| | -30 °C, MM | -30 °C, MM | -30 °C, MM | -30 °C, MM | -30 °C, MM | -30 °C, MM | -30 °C, MM |
| Sizes | 52 to 61 cm | 52 to 61 cm | 52 to 61 cm | 52 to 61 cm | 52 to 61 cm | 52 to 61 cm | 52 to 61 cm |
| Order unit | PC | PC | PC | PC | PC | PC | PC |
| Outer packaging | 25 PC per CT | 25 PC per CT | 25 PC per CT | 25 PC per CT | 25 PC per CT | 25 PC per CT | 25 PC per CT |

MADE IN GERMANY



Safety Helmets

uvex pheos E · uvex pheos E-WR · uvex pheos E-S-WR



uvex pheos E · uvex pheos E-WR

- safety helmet with slots for uvex visors, earmuffs and lamps
- side Euroslot adapters (30 mm) for attaching earmuffs
- suitable for use by electricians as helmet shell is fully enclosed
- meets standard EN 397 and additional requirements for very low temperatures (-30 °C) and molten metal (MM) splash and is approved in accordance with EN 50365 (1000 V AC)
- conventional suspension harness for comfortable adjustable fit (uvex pheos E)
- suspension harness with wheel ratchet for variable width adjustment (uvex pheos E-WR)
- fitted with the 9760005 (uvex pheos E) or 9760009 (uvex pheos E-WR) sweatband
- six-point textile band attachment ensures optimal fit and comfort

| uvex pheos E with conventional suspension harness | | |
|---|---------------------|---------------------|
| Art. no. | 9770020 | 9770120 |
| Colour | white | yellow |
| Version | with long brim | with long brim |
| Material | HDPE | HDPE |
| Standard | EN 397 | EN 397 |
| | -30 °C, MM | -30 °C, MM |
| | EN 50365, 1000 V AC | EN 50365, 1000 V AC |
| Sizes | 51 to 61 cm | 51 to 61 cm |
| Order unit | PC | PC |
| Outer packaging | 25 PC per CT | 25 PC per CT |

| uvex pheos E-WR with wheel ratchet system | | | | | | | |
|---|---------------------|---------------------|---------------------|---------------------|---------------------|---------------------|---------------------|
| Art. no. | 9770030 | 9770130 | 9770230 | 9770330 | 9770430 | 9770530 | 9770830 |
| Colour | white | yellow | orange | red | green | blue | dark grey |
| Version | with long brim | with long brim | with long brim | with long brim | with long brim | with long brim | with long brim |
| Material | HDPE | HDPE | HDPE | HDPE | HDPE | HDPE | HDPE |
| Standard | EN 397 | EN 397 | EN 397 | EN 397 | EN 397 | EN 397 | EN 397 |
| | -30 °C, MM | -30 °C, MM | -30 °C, MM | -30 °C, MM | -30 °C, MM | -30 °C, MM | -30 °C, MM |
| | EN 50365, 1000 V AC | EN 50365, 1000 V AC | EN 50365, 1000 V AC | EN 50365, 1000 V AC | EN 50365, 1000 V AC | EN 50365, 1000 V AC | EN 50365, 1000 V AC |
| Sizes | 52 to 61 cm | 52 to 61 cm | 52 to 61 cm | 52 to 61 cm | 52 to 61 cm | 52 to 61 cm | 52 to 61 cm |
| Order unit | PC | PC | PC | PC | PC | PC | PC |
| Outer packaging | 25 PC per CT | 25 PC per CT | 25 PC per CT | 25 PC per CT | 25 PC per CT | 25 PC per CT | 25 PC per CT |



uvex pheos E-S-WR

- safety helmet with slots for uvex visors, earmuffs and lamps
- side Euroslot adapters (30 mm) for attaching earmuffs
- suitable for use by electricians as helmet shell is fully enclosed
- meets standard EN 397 and additional requirements for very low temperatures (-30 °C) and molten metal (MM) splash and is approved in accordance with EN 50365 (1000 V AC)
- suspension harness with wheel ratchet for variable width adjustment
- fitted with the 9760009 sweatband
- shorter brim for a wider field of upward vision
- six-point textile band attachment ensures optimal fit and comfort

| uvex pheos E-S-WR with wheel ratchet system | | | | | | | | |
|---|-----------------|-----------------|-----------------|-----------------|-----------------|-----------------|-----------------|-----------------|
| Art. no. | 9770031 | 9770131 | 9770231 | 9770331 | 9770431 | 9770531 | 9770832 | 9770931 |
| Colour | white | yellow | orange | red | green | blue | dark grey | black |
| Version | with short brim | with short brim | with short brim | with short brim | with short brim | with short brim | with short brim | with short brim |
| Material | HDPE | HDPE | HDPE | HDPE | HDPE | HDPE | HDPE | HDPE |
| Standard | EN 397 | EN 397 | EN 397 | EN 397 | EN 397 | EN 397 | EN 397 | EN 397 |
| | -30 °C, MM | -30 °C, MM | -30 °C, MM | -30 °C, MM | -30 °C, MM | -30 °C, MM | -30 °C, MM | -30 °C, MM |
| | EN 50365 | EN 50365 | EN 50365 | EN 50365 | EN 50365 | EN 50365 | EN 50365 | EN 50365 |
| | 1000 V AC | 1000 V AC | 1000 V AC | 1000 V AC | 1000 V AC | 1000 V AC | 1000 V AC | 1000 V AC |
| Sizes | 52 to 61 cm | 52 to 61 cm | 52 to 61 cm | 52 to 61 cm | 52 to 61 cm | 52 to 61 cm | 52 to 61 cm | 52 to 61 cm |
| Order unit | PC | PC | PC | PC | PC | PC | PC | PC |
| Outer packaging | 25 PC per CT | 25 PC per CT | 25 PC per CT | 25 PC per CT | 25 PC per CT | 25 PC per CT | 25 PC per CT | 25 PC per CT |



Safety Helmets

uvex 9780 antistatic · uvex 9780 antistatic-WR · reflex set



9780020



9780030



9780550

uvex 9780 antistatic · uvex 9780 antistatic-WR

- three variable air vents for maximum ventilation
- side Euroslot adapters (30 mm) for attaching earmuffs
- meets standard EN 397 and additional requirement for molten metal (MM) splash
- antistatic in accordance with DIN EN 60079-32-2
- six-point textile band attachment ensures ideal fit and comfort
- fitted with the 9760005 sweatband
- conventional suspension harness for individual, comfortable adjustable fit (uvex 9780 antistatic)
- suspension harness with wheel ratchet system for variable width adjustment (uvex 9780 antistatic WR)

| | uvex 9780 antistatic | uvex 9780 antistatic-WR | |
|------------------------|----------------------------|----------------------------|----------------------------|
| Art. no. | 9780020 | 9780030 | 9780550 |
| Colour | white | white | sky blue |
| Version | with long brim | with long brim | with long brim |
| Material | PP | PP | PP |
| Standard | EN 397, MM IEC 60079-32 | EN 397, MM IEC 60079-32 | EN 397, MM IEC 60079-32 |
| Sizes | 51 to 61 cm | 52 to 61 cm | 52 to 61 cm |
| Order unit | PC | PC | PC |
| Outer packaging | 25 PC per CT | 25 PC per CT | 25 PC per CT |

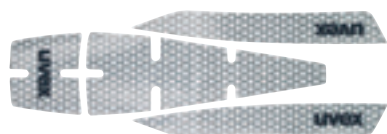

9790018



uvex pheos reflex set L
(select preferred helmet colour)

uvex pheos reflex set M

- highly reflective sticker set
- extremely high brightness with prism film
- easy to affix
- suitable for all uvex pheos and uvex pheos alpine safety helmets

| uvex pheos reflex set M | |
|-------------------------|---------|
| Art. no. | 9790018 |
| Order unit | PC |

uvex pheos reflex set L

- safety helmet with highly reflective sticker set
- helmets are delivered with the stickers already applied
- customized helmets cannot be exchanged

► Please contact our service hotline free of charge on **+49 911 9736-0**.

| uvex pheos reflex set L | | |
|--|--------|---|
| Art. no. | Colour | Version |
| 9772026 | white | uvex pheos B with reflective sticker |
| 9772126 | yellow | uvex pheos B with reflective sticker |
| 9772226 | orange | uvex pheos B with reflective sticker |
| 9772326 | red | uvex pheos B with reflective sticker |
| 9772526 | blue | uvex pheos B with reflective sticker |
| 9772926 | black | uvex pheos B with reflective sticker |
| 9772035 | white | uvex pheos B-WR with reflective sticker |
| 9772138 | yellow | uvex pheos B-WR with reflective sticker |
| 9772236 | orange | uvex pheos B-WR with reflective sticker |
| 9772437 | green | uvex pheos B-WR with reflective sticker |
| 9772538 | blue | uvex pheos B-WR with reflective sticker |
| 9772936 | black | uvex pheos B-WR with reflective sticker |
| 9772038 | white | uvex pheos B-S-WR with reflective sticker |
| 9772137 | yellow | uvex pheos B-S-WR with reflective sticker |
| 9772239 | orange | uvex pheos B-S-WR with reflective sticker |
| 9772334 | red | uvex pheos B-S-WR with reflective sticker |
| 9772537 | blue | uvex pheos B-S-WR with reflective sticker |
| 9770026 | white | uvex pheos E with reflective sticker |
| 9770126 | yellow | uvex pheos E with reflective sticker |
| 9770036 | white | uvex pheos E-WR with reflective sticker |
| 9770136 | yellow | uvex pheos E-WR with reflective sticker |
| 9770536 | blue | uvex pheos E-WR with reflective sticker |
| Order quantity multiples/ 25 PC | | |
| Order unit | | |

Forestry worker set

Specially developed to meet the needs of forestry workers



Perfect 'resting position' for the visor and hearing protection

Based on the uvex pheos visor system, the visor can be locked above the helmet shell when not required and the hearing protection can be folded back. Everything fits closely to the helmet and is perfectly balanced over the body's centre of gravity. This means the neck muscles are not placed under strain by any unnecessary weight, ensuring excellent wearer comfort and maximum freedom of movement. So hitting or getting caught on overhead branches is now a thing of the past. Plus, your view is not restricted by the visor when in the resting position (visor open) either.



Perfect helmet climate:

Three variable air vents ensure maximum ventilation. In cold weather, the vents can easily be closed from the outside using sliders. Ventilation in the direction of movement ensures optimum air flow.



Emergency whistle included in uvex pheos forestry set



Wide range of accessories

The set comes as standard with a four-point chin strap and signal whistle. In the event of an emergency, the signal whistle makes it possible to emit a sustained rescue or warning signal over two frequencies and is significantly louder than the human voice: extremely loud for maximum range. Made from a single piece without moving parts to reliably ensure long-term functionality. Clipped into the helmet and therefore always at hand in an emergency. Alternatively, the whistle can be attached to a key ring or a cord.

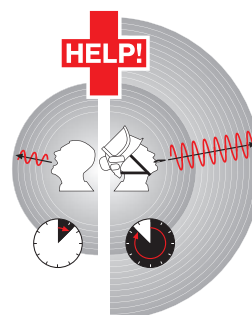

High wearer comfort

Thanks to soft sweatband and wheel ratchet padding.

Safety Helmets

uvex pheos forestry · uvex pheos ABS



Further information can be found at uvex-safety.com/en/forestryset (or scan the QR code).



uvex pheos forestry

- set specially developed to meet the needs of forestry workers, consisting of the uvex pheos ABS B-S-WR, uvex pheos forestry visor and uvex pheos K2P mechanical
- labelled with label set, including pre-attached chin strap and signal whistle
- meets standards EN 166, 1731, 352-1 and 397 and additional requirement for very low temperatures (-30 °C)
- fully integrated metal mesh visor with high transmission (transparency) protects against foreign objects and ensures a clear view
- high-insulation earmuffs (SNR: 30 dB) round off the system perfectly and reliably protect against noise produced by chainsaws and brush cutters
- three variable air vents for maximum ventilation, offering ventilation in the direction of movement
- suspension harness with wheel ratchet system enables the width to be variably adjusted with just one hand

| uvex pheos forestry - pre-assembled set | | | |
|---|--------------------|--------------------|--------------------|
| Art. no. | 9774236 | 9774237 | 9774238 |
| Colour | yellow | orange | red |
| Version | with short brim | with short brim | with short brim |
| Material | ABS | ABS | ABS |
| Standard | EN 397, -30 °C, MM | EN 397, -30 °C, MM | EN 397, -30 °C, MM |
| | EN 1731:2006-F | EN 1731:2006-F | EN 1731:2006-F |
| | EN 352-3 | EN 352-3 | EN 352-3 |
| Sizes | 52 to 61 cm | 52 to 61 cm | 52 to 61 cm |
| Order unit | PC | PC | PC |
| Outer packaging | 15 PC per CT | 15 PC per CT | 15 PC per CT |

| uvex pheos forestry - spare parts | | |
|-----------------------------------|--|------------|
| Art. no. | | Order unit |
| 9790210 | Replacement visor (metal) | PC |
| 2600214 | uvex K2P mechanical | PC |
| 9760106 | Replacement suspension harness pheos ABS | PC |
| 9760009 | Sweatband pheos ABS | PC |
| 9790021 | Four-point chin strap | PC |
| 9790146 | Signal whistle | PC |



MADE IN GERMANY



Conformity assessment not yet completed

Conformity assessment not yet completed

uvex pheos ABS

- ABS safety helmet with slots for uvex visors, earmuffs and helmet lamps
- side Euroslot adapters (30 mm) for attaching earmuffs
- meets EN 397 standards and additional requirements for very low temperatures (-30°C)
- high lateral rigidity
- three variable air vents for maximum ventilation
- conventional suspension harness for comfortable adjustable fit (uvex pheos B)
- suspension harness fitted with wheel ratchet system (9760012) and sweatband (9760009)
- six-point textile band attachment ensures optimum fit and comfort

| uvex pheos ABS B-S-WR with wheel ratchet system | | | | |
|---|-----------------|-----------------|-----------------|-----------------|
| Art. no. | 9772071 | 9772171 | 9772271 | 9772371 |
| Colour | white | yellow | orange | red |
| Version | with short brim | with short brim | with short brim | with short brim |
| Material | ABS | ABS | ABS | ABS |
| Standard | EN 397 | EN 397 | EN 397 | EN 397 |
| | -30 °C, MM | -30 °C, MM | -30 °C, MM | -30 °C, MM |
| | 52 to 61 cm | 52 to 61 cm | 52 to 61 cm | 52 to 61 cm |
| Order unit | PC | PC | PC | PC |
| Outer packaging | 24 PC per CT | 24 PC per CT | 24 PC per CT | 24 PC per CT |

uvex pheos alpine

Head protection doesn't get much more versatile than this



The uvex pheos alpine combines the various requirements of the industrial sector (in accordance with EN 397) and mountain climbing or working at height (in accordance with EN 12492) in one helmet with an unparalleled fit.



Multifunctional

Thanks to the clip at the back of the helmet, the chin strap can be stored inside the helmet in line with EN 12492 and released as needed. Leather chin strap compatible with EN 397 also included.



Excellent compatibility

The front and side slots make it easy to attach accessories.

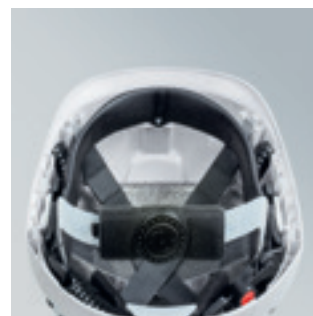

Additional comfort

Thanks to soft sweatband and wheel ratchet padding.



Clips for attaching goggles or LED head torches with headband.

Safety Helmets

uvex pheos alpine



uvex pheos alpine

- multifunctional helmet for working at heights and rescue operations
- combines the features of an industrial protection helmet (EN 397) with the requirements for a climbing helmet (EN 12492)
- light ABS helmet shell offers a high level of protection and durability
- shorter brim for a wider field of upward vision
- side Euroslot adapters (30 mm) for attaching earmuffs and visor
- options for attaching head torches and goggles
- permanently opened air vents
- meets standard EN 397 and additional requirements for very low temperatures (-30°C)
- riveted chin strap (art. no. 970005) for use in accordance with EN 397
- six-point textile band attachment ensures ideal fit and great comfort
- suspension harness with wheel ratchet system for variable width adjustment

- the helmet is delivered as standard with a black PU sweatband (art. no. 9760009); there is also an option of a light sweatband made of synthetic leather (art. no. 9760005)



product design award

2013 ■

uvex pheos alpine with wheel ratchet system

| Art. no. | 9773050 | 9773150 | 9773250 | 9773350 | 9773450 | 9773550 | 9773950 |
|-----------------|--|--|--|--|--|--|--|
| Colour | white | yellow | orange | red | green | blue | black |
| Version | with short brim | with short brim | with short brim | with short brim | with short brim | with short brim | with short brim |
| Material | ABS | ABS | ABS | ABS | ABS | ABS | ABS |
| Standard | EN 397, -30 °C EN 12492 | EN 397, -30 °C EN 12492 | EN 397, -30 °C EN 12492 | EN 397, -30 °C EN 12492 | EN 397, -30 °C EN 12492 | EN 397, -30 °C EN 12492 | EN 397, -30 °C EN 12492 |
| Sizes | 52 to 61 cm | 52 to 61 cm | 52 to 61 cm | 52 to 61 cm | 52 to 61 cm | 52 to 61 cm | 52 to 61 cm |
| Order unit | PC, | PC, | PC, | PC, | PC, | PC, | PC, |
| Outer packaging | individually packed in CT 6 PC per CT | individually packed in CT 6 PC per CT | individually packed in CT 6 PC per CT | individually packed in CT 6 PC per CT | individually packed in CT 6 PC per CT | individually packed in CT 6 PC per CT | individually packed in CT 6 PC per CT |

Safety Helmets

uvex airwing B · uvex airwing B-WR · uvex super boss



uvex airwing B · uvex airwing B-WR

- safety helmet with slots for uvex visors and earmuffs
- side Euroslot adapters (30 mm) for attaching earmuffs
- meets standard EN 397 and additional requirement for very low temperatures (-30 °C)
- three variable air vents for maximum ventilation
- conventional suspension harness for comfortable adjustable fit (uvex airwing B)
- suspension harness with wheel ratchet for variable width adjustment (uvex airwing B-WR)
- fitted with the 9760005 sweatband
- six-point textile band attachment ensures optimal fit and comfort

| uvex airwing B with conventional suspension harness | | | | | | | |
|---|----------------|----------------|----------------|----------------|----------------|----------------|----------------|
| Art. no. | 9762020 | 9762120 | 9762220 | 9762320 | 9762420 | 9762520 | 9762920 |
| Colour | white | yellow | orange | red | green | blue | black |
| Version | with long brim | with long brim | with long brim | with long brim | with long brim | with long brim | with long brim |
| Material | HDPE | HDPE | HDPE | HDPE | HDPE | HDPE | HDPE |
| Standard | EN 397, -30 °C | EN 397, -30 °C | EN 397, -30 °C | EN 397, -30 °C | EN 397, -30 °C | EN 397, -30 °C | EN 397, -30 °C |
| Sizes | 51 to 61 cm | 51 to 61 cm | 51 to 61 cm | 51 to 61 cm | 51 to 61 cm | 51 to 61 cm | 51 to 61 cm |
| Order unit | PC | PC | PC | PC | PC | PC | PC |
| Outer packaging | 25 PC per CT | 25 PC per CT | 25 PC per CT | 25 PC per CT | 25 PC per CT | 25 PC per CT | 25 PC per CT |

| uvex airwing B-WR with wheel ratchet system | | | | | | |
|---|----------------|----------------|----------------|----------------|----------------|----------------|
| Art. no. | 9762030 | 9762130 | 9762230 | 9762330 | 9762430 | 9762530 |
| Colour | white | yellow | orange | red | green | blue |
| Version | with long brim | with long brim | with long brim | with long brim | with long brim | with long brim |
| Material | HDPE | HDPE | HDPE | HDPE | HDPE | HDPE |
| Standard | EN 397, -30 °C | EN 397, -30 °C | EN 397, -30 °C | EN 397, -30 °C | EN 397, -30 °C | EN 397, -30 °C |
| Sizes | 52 to 61 cm | 52 to 61 cm | 52 to 61 cm | 52 to 61 cm | 52 to 61 cm | 52 to 61 cm |
| Order unit | PC | PC | PC | PC | PC | PC |
| Outer packaging | 25 PC per CT | 25 PC per CT | 25 PC per CT | 25 PC per CT | 25 PC per CT | 25 PC per CT |



uvex super boss

- safety helmet with slots for uvex visors and earmuffs
- side Euroslot adapters (30 mm) for attaching earmuffs
- meets standard EN 397 and additional requirement for very low temperatures (-20 °C)
- conventional suspension harness for comfortable adjustable fit
- fitted with the 9790004 sweatband
- adjustable side ventilation slits
- six-point textile band attachment ensures optimal fit and comfort

| uvex super boss with conventional suspension harness | | | |
|--|----------------|----------------|----------------|
| Art. no. | 9750020 | 9750120 | 9750520 |
| Colour | white | yellow | blue |
| Version | with long brim | with long brim | with long brim |
| Material | HDPE | HDPE | HDPE |
| Standard | EN 397, -20 °C | EN 397, -20 °C | EN 397, -20 °C |
| Sizes | 52 to 61 cm | 52 to 61 cm | 52 to 61 cm |
| Order unit | PC | PC | PC |
| Outer packaging | 25 PC per CT | 25 PC per CT | 25 PC per CT |

Safety Helmets

uvex airwing B-S · uvex airwing B-S-WR · uvex thermo boss



uvex airwing B-S · uvex airwing B-S-WR

- safety helmet with slots for uvex visors and earmuffs
- side Euroslot adapters (30 mm) for attaching earmuffs
- meets standard EN 397 and additional requirement for very low temperatures (-30 °C)
- three variable air vents for maximum ventilation
- conventional suspension harness for comfortable adjustable fit (uvex airwing B-S)
- suspension harness with wheel ratchet for variable width adjustment (uvex airwing B-S-WR)
- fitted with the 9760005 sweatband
- shorter brim for a wider field of upward vision
- six-point textile band attachment ensures optimal fit and comfort

uvex airwing B-S with conventional suspension harness

| | | | | | | |
|-----------------|-----------------|-----------------|-----------------|-----------------|-----------------|-----------------|
| Art. no. | 9762021 | 9762121 | 9762221 | 9762321 | 9762421 | 9762521 |
| Colour | white | yellow | orange | red | green | blue |
| Version | with short brim | with short brim | with short brim | with short brim | with short brim | with short brim |
| Material | HDPE | HDPE | HDPE | HDPE | HDPE | HDPE |
| Standard | EN 397, -30 °C | EN 397, -30 °C | EN 397, -30 °C | EN 397, -30 °C | EN 397, -30 °C | EN 397, -30 °C |
| Sizes | 51 to 61 cm | 51 to 61 cm | 51 to 61 cm | 51 to 61 cm | 51 to 61 cm | 51 to 61 cm |
| Order unit | PC | PC | PC | PC | PC | PC |
| Outer packaging | 25 PC per CT | 25 PC per CT | 25 PC per CT | 25 PC per CT | 25 PC per CT | 25 PC per CT |

uvex airwing B-S-WR with wheel ratchet system

| | | | | | | |
|-----------------|-----------------|-----------------|-----------------|-----------------|-----------------|-----------------|
| Art. no. | 9762031 | 9762131 | 9762231 | 9762331 | 9762431 | 9762531 |
| Colour | white | yellow | orange | red | green | blue |
| Version | with short brim | with short brim | with short brim | with short brim | with short brim | with short brim |
| Material | HDPE | HDPE | HDPE | HDPE | HDPE | HDPE |
| Standard | EN 397, -30 °C | EN 397, -30 °C | EN 397, -30 °C | EN 397, -30 °C | EN 397, -30 °C | EN 397, -30 °C |
| Sizes | 52 to 61 cm | 52 to 61 cm | 52 to 61 cm | 52 to 61 cm | 52 to 61 cm | 52 to 61 cm |
| Order unit | PC | PC | PC | PC | PC | PC |
| Outer packaging | 25 PC per CT | 25 PC per CT | 25 PC per CT | 25 PC per CT | 25 PC per CT | 25 PC per CT |



uvex thermo boss

- safety helmet with slots for uvex visors and earmuffs
- the helmet shell is made from heat-resistant polycarbonate and is suitable for use in high ambient temperatures.
- side Euroslot adapters (30 mm) for attaching earmuffs
- meets standard EN 397 and additional requirement (440 V AC) +150 °C
- conventional suspension harness for comfortable adjustable fit
- fitted with the 9790004 sweatband
- six-point textile band attachment ensures optimal fit and comfort

uvex thermo boss

| | | | |
|-----------------|-------------------------------|-------------------|-------------------|
| Art. no. | 9754000 | 9754100 | 9754300 |
| Colour | white | yellow | red |
| Version | with long brim | with long brim | with long brim |
| Material | PC reinforced with fibreglass | | |
| Standard | EN 397 | EN 397 | EN 397 |
| | +150 °C, 440 V AC | +150 °C, 440 V AC | +150 °C, 440 V AC |
| Sizes | 52 to 61 cm | 52 to 61 cm | 52 to 61 cm |
| Order unit | PC | PC | PC |
| Outer packaging | 25 PC per CT | 25 PC per CT | 25 PC per CT |

MADE IN GERMANY



Safety Helmets

Accessories



9790065
with safety helmet
(helmet not included)



9790075
with safety helmet
(helmet not included)



9790076
with safety helmet
(helmet not included)



9790068



9790066



9790086
with safety helmet
(helmet not included)



9790086

uvex winter cap

- winter cap for use in all uvex helmets
- windproof and waterproof outer material
- all-around reflective strip
- side mesh to increase the wearer's attention to environmental influences (ear area)
- warming fleece lining

uvex balaclava

- uvex balaclava is the ideal addition to the winter cap – with continuous size adjustment through hinged Velcro fastening

uvex neck protection

- uvex neck protection for protection against rain, dust, splinters and solar radiation
- for use with all uvex helmets
- fitted with mount 9790022 to attach the neck protection in the uvex pheos helmet shell

uvex cooling neck protection

- with unique cooling function – up to 8 hours cooling effect, protection from sunlight

| | uvex winter cap | uvex balaclava | uvex neck protection | uvex cooling neck protection |
|------------|------------------|------------------|----------------------|------------------------------|
| Art. no. | 9790065 | 9790068 | 9790066 | 9790075 |
| Version | polyester/fleece | polyester/fleece | fleece | polyester |
| Colour | hi-viz yellow | hi-viz orange | black | orange |
| Sizes | unisize | unisize | unisize | unisize |
| Order unit | PC | PC | PC | PC |

9790006



9790010



9790015



9790016



9790012



Paper caps · Winter caps

| | Paper cap | Winter caps | | | |
|------------|------------------------|------------------------------------|---------------------------------------|---------------------------------------|------------------------------------|
| Art. no. | 9790006 | 9790010 | 9790015 | 9790016 | 9790012 |
| Version | gygienic visitor hoods | winter hat made of cotton and wool | winter hat made of polyester and wool | winter hat made of polyester and wool | winter hat made of cotton and wool |
| Colour | white | navy blue | black | black | navy blue |
| Sizes | unisize | unisize | S to M | L to XL | unisize |
| Order unit | 100 PC | PC | PC | PC | PC |

Safety Helmets

Accessories



Accessories for uvex super boss and uvex thermo boss

| | | |
|-------------------|---|--|
| | Suspension harness for uvex super boss and uvex thermo boss | Sweatband for uvex super boss and uvex thermo boss |
| Art. no. | 9790000 | 9790004 |
| Version | Six-point textile attachment with sweatband | Plastic |
| Order unit | PC | PC |



Accessories for uvex pheos IES

| | | |
|-------------------|--|-------------------------|
| | Suspension harness for IES For uvex pheos (Not pheos E and pheos alpine) | Sweatband for pheos IES |
| Art. no. | 9772001 | 9760007 |
| Version | Six-point textile suspension with textile sweatband with uvex pheos glasses clip | textile/foam material |
| Order unit | PC | PC |



Accessories for uvex pheos E-WR and uvex pheos alpine

| | | |
|-------------------|---|---|
| | Suspension harness for uvex pheos E-WR | Suspension harness for uvex pheos alpine |
| Art. no. | 9760012 | 9760011 |
| Version | Six-point textile attachment with sweatband | Six-point textile attachment with sweatband |
| Order unit | PC | PC |
| | Sweatband for uvex pheos alpine and uvex pheos E-WR | Wheel ratchet padding |
| Art. no. | 9760009 | 9760014 |
| Version | PU, leather | polyester |
| Order unit | PC | PC |

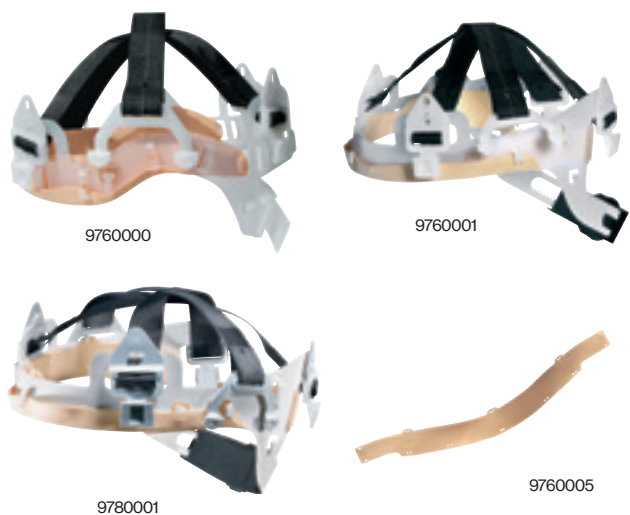

Accessories for uvex pheos, uvex airwing and uvex 9780 antistatic

| | | |
|-------------------|---|--|
| | Conventional suspension harness for uvex pheos and uvex airwing | Suspension harness for uvex pheos and uvex airwing (not for uvex pheos E) with wheel ratchet |
| Art. no. | 9760000 | 9760001 |
| Version | Six-point textile attachment with sweatband | Six-point textile attachment with sweatband |
| Order unit | PC | PC |
| | Suspension harness for uvex 9780 antistatic with wheel ratchet | Sweatband for uvex pheos, uvex 9780 antistatic, uvex airwing and uvex pheos alpine |
| Art. no. | 9780001 | 9760005 |
| Version | Six-point textile attachment with sweatband | Six-point textile attachment |
| Order unit | PC | PC |

Safety Helmets

Accessories



Accessories for uvex pheos, uvex pheos alpine, uvex airwing, uvex 9780 antistatic, uvex super boss and uvex thermo boss

| | | |
|---------------------------------|--|--|
| | Leather chin straps for uvex pheos (not for pheos IES and pheos E), uvex pheos alpine, uvex airwing, uvex superboss and uvex thermo boss | |
| Art. no. | 9790005 | |
| Version | Robust leather design with plastic eyelets with metal rivets, adjustable length | |
| Order unit | PC | |
| | Forked chin straps for uvex airwing and uvex pheos | Leather chin strap for uvex pheos IES |
| Art. no. | 9790007 | 9790035 |
| Version | textile band with push-button quick-action fastener plastic eyelets and chin pad, length can be adjusted | Robust leather design with plastic eyelets with metal rivets, length can be adjusted |
| Order unit | PC | PC |
| | Forked chin straps for uvex pheos (not for uvex pheos alpine) uvex pheos E and uvex 9780 antistatisch | |
| Art. no. | 9790021 | |
| Version | Textile strap with quick-release push-button fastening, plastic hooks and chin pad, adjustable length | |
| Order unit | PC | |
| | IES mount with sliding element for uvex pheos IES System | Penholder for uvex pheos and uvex pheos E |
| Art. no. | 9772002 | 9790023 |
| Version | plastic | plastic |
| Order unit | PC | PC |
| | Goggles clip for uvex pheos/ chin strap clip for uvex pheos alpine | |
| Art. no. | 9790022 | |
| Version | Textile strap with quick-release push-button fastening, plastic hooks and chin pad, adjustable length | |
| Order unit | PC | |
| | Business card holder | |
| Art. no. | 9790106 | |
| Content | 10 holders + 20 PVC cards | |
| Order quantity multiples | 10 PC | |
| | uvex helmet bag for storing and transporting the uvex safety helmet | Helmet slot sealing plug set |
| Art. no. | 9790071 | 9790077 |
| Version | polyester | plastic |
| Order unit | PC | PC |

Safety Helmets

Accessories: Head torchs

► All uvex LED head torches fit into the front slot of the uvex pheos, uvex pheos alpine and uvex 9780 antistatic.



9790062
9790063

uvex head torch pheos Lights · pheos Lights EX

- LED helmet torch with two separate reflectors for distance and area lighting
- four different operating modes
- compact design, very low weight (80 g), extremely robust
- power source: 1.7 Ah-Li-Ion battery
- luminous flux: up to max. 115 lumen
- illuminance: max. 6500 lux
- light duration: 11 hours
- operating temperature: -20 °C to + 60 °C
- charge adapter and micro-USB charger included

- protection class IP 67 (dust-tight and waterproof)
- 9790063: ATEX certification II 2G Ex ib IIC T4

| Press switch | Modes | Lumen | Range | Light duration |
|----------------|-------|-------|-------|----------------|
| Area light | low | 55 | 5 m | 11 h |
| | high | 115 | 10 m | 5.5 h |
| Distance light | low | 55 | 50 m | 11 h |
| | high | 115 | 100 m | 5.5 h |



| | LED head torch pheos Lights | LED head torch pheos Lights EX |
|-------------------|-----------------------------|--------------------------------|
| Art. no. | 9790062 | 9790063 |
| Version | for uvex pheos helmets | for uvex pheos helmets – ATEX |
| Order unit | PC | PC |



9790029



KS-6001-DUO

- LED helm torch with two switching steps
- four different operating modes
- compact design and light weight (115 g)
- power source: 1.7-Ah Li-Ion battery
- luminous flux: up to max. 200 lumen
- illuminance: max. 8500 lux
- light duration: 11 hours
- operating temperature: -20 °C to +60 °C
- charger included
- charging time: approx. 5 hours
- protection class IP67 (dust-tight and waterproof)

| Press switch | Modes | Lumen | Range | Light duration |
|----------------|--------|-------|-------|----------------|
| Area light | normal | 80 | 5 m | 11 h |
| | strong | 200 | 10 m | 4 h |
| Distance light | normal | 80 | 80 m | 11 h |
| | strong | 160 | 180 m | 5.5 h |

| LED head torch KS-6001-DUO | | | | |
|----------------------------|--|--|--|--|
| Art. no. | 9790029 | | | |
| Version | for uvex pheos, uvex pheos alpine and uvex 9780 antistatic helmets | | | |
| Order unit | PC | | | |



9790064



LED head torch u-cap sport · uvex pheos helmet adapter

- LED head torch with two separate reflectors for distance and area lighting
- two different operating modes
- sturdy design, with very low weight (55 g without batteries)
- power source: 3 x AAA batteries (not included)
- luminous flux: up to max. 190 lumen
- illuminance: approx. 4000 lux
- light duration: up to max. 150 hrs
- operating temperature: -20 °C to +45 °C
- protection class IP 66 (complete protection against dust and powerful water jets)
- Adapter for the LED head torch u-cap sport for combining with the uvex pheos and uvex pheos alpine helmets

| Press switch for 1 s | Modes | Lumen | Range | Light duration |
|----------------------|--------|-------|-------|----------------|
| Distance light | medium | 40 | 80 m | 70 h |
| | high | 100 | 110 m | 30 h |
| | low | 5 | 10 m | 150 h |
| Area light | high | 30 | 7 m | 80 h |
| | low | 10 | 3 m | 150 h |



9790069

| | LED head torch uvex u-cap sport | uvex pheos helmet adapter |
|-------------------|---------------------------------|---|
| Art. no. | 9790064 | 9790069 |
| Version | for uvex u-cap sport | for LED head torch uvex u-cap sport for combining with the uvex pheos and uvex pheos alpine helmets |
| Order unit | PC | PC |

Safety Helmets

Accessories: Head torchs



9790213



Suprabeam V3air rechargeable

- LED head torch with sliding focus for distance and area lighting
- can be dimmed between 180 and 8 lumens
- two different operating modes
- robust design with low weight (148 g); weight balanced by battery at the rear
- power source: 1.4-Ah LiPo battery
- luminous flux: up to max. 320 lumen
- light duration: max. 100 hours
- operating temperature: -30°C to +60°C
- IPX4 protection (protection against splashing water from all directions)
- highly adjustable angle: illuminates an area in the distance or directly in front of the wearer
- range up to 210 metres

Suprabeam V3air rechargeable

Art. no. 9790213

Version with headband; suitable for all uvex helmets with article 9790214

Order unit PC



9790214

Universal silicone strap for Suprabeam V3air rechargeable

- for attachment to all uvex protective helmets
- prevents lamp from slipping off helmet

Universal silicone strap

Art. no. 9790214

Version for V3air rechargeable

Order unit PC



uvex

Rubrik
Seitenheadline



uvex

Visors and face protection

Visor lenses, certification and norms

Specially developed to meet the needs of forestry workers



Polycarbonate lenses with uvex supravision excellence coating

Polycarbonate has a high mechanical impact strength. Coated lenses are anti-fog on the inside, and scratch- and chemical-resistant on the outside. The anti-fogging properties are permanent even after repeated cleaning. The lenses are especially easy to clean and less susceptible to dirt due to the non-stick nanotechnology.

Cellulose acetate lenses

Face protection visors made of cellulose acetate are ideally suited for protection against chemicals.

Nylon mesh

is light in weight and non-conductive. It is very flexible and durable, and therefore frequently used in agriculture and forestry.

Stainless steel mesh

is robust and has excellent stability and long life. Stainless steel mesh visors offer a higher light transmission than nylon mesh visors and are used for more rugged work in agriculture and forestry.

Standards at a glance

EN 166 – Personal eye protection

The European standard EN166 applies to all types of eye protection. EN 166 visors are made of frames and lenses.

Certification according to DIN EN 166

Marking on frame

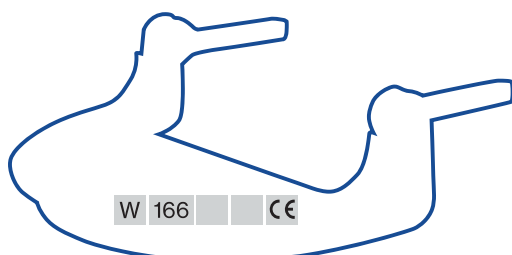

Marking on lenses

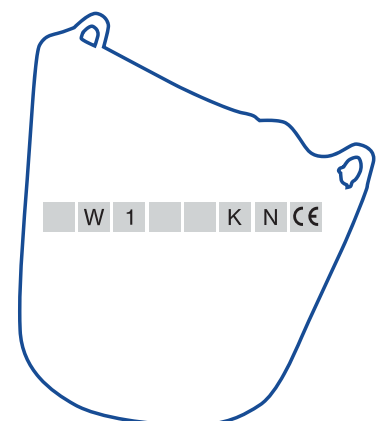

A detailed description of frame and lens markings can be found on page 17

Labelling and norms

EN 170 – Ultraviolet protection filters

In the standards for special product requirements, the standard EN 170 sets out levels of protection and transmission requirements for ultraviolet protection filters. Excessive exposure to ultraviolet light can cause the lens of the eye to lose its transparency, which may cause

visual impairment or loss of vision. Visor lenses in accordance with EN 170 therefore meet performance requirements to protect the eye from ultraviolet radiation during hazardous work.

EN 1731 – Textile face protection

The European standard EN 1731 describes all requirements for personal eye and face protection made of textile. EN 1731 visors consist of frames and lenses.

Technical information on the frame and the lens are specified according to EN 1731 in the following order:

- Identification of the manufacturer
- Number of European standard
- Symbol for mechanical strength

| Mechanical strength | |
|---------------------|---|
| none | without mechanical strength (filters only) |
| S | increased strength (filters only) |
| F | low energy impact (45m/s) |
| B | medium energy impact (120m/s) |
| A | high energy impact (190 m/s) |
| T | tested at extreme temperatures (-5°C and +55°C) |



GS-ET 29

When working on energised electrical systems and equipment, the risk of a short circuit electric arc must be assessed. Short circuit electric arcs are usually caused by a short circuit between the electrical lines. The GS-ET 29 test principle is an additional requirement for the testing and certification of electrician face protection. This is a category 3

product, which means there is a risk of physical injury and death. With regards to different intensities of short circuit electric arcs, the certified products must be assessed for their suitability for the respective application. Here, there are distinctions between two classes, Class 1 – up to 4 kA – and Class 2, up to 7 kA.

Certification according to GS-ET 29

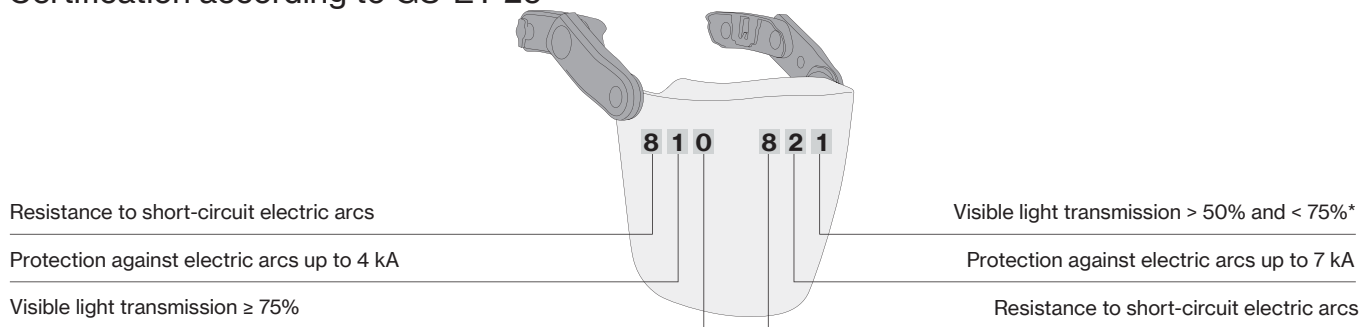

Previously



According to 7 kA short circuit electric arc

uvex

uvex i-gonomics

Face protection with measurably greater relief

uvex i-gonomics redefines wearer comfort: The innovative product system boasts an ergonomic fit, lightweight design and ideal climate characteristics. This makes our face protection more comfortable to wear and gives it optimal flexibility – so maximum performance can be achieved at all times, even under extreme conditions.



uvex pheos faceguard

Innovative and systematic face protection.

The uvex pheos faceguard has been ergonomically designed. It evenly distributes the weight across the body's centre of gravity, helping the wearer to adopt a natural posture. The slim design ensures optimal freedom of movement and the robust polycarbonate visor provides a clear view.

Thanks to uvex coating technology, the guard is anti-fog on the inside and extremely scratch- and chemical-resistant on the outside. uvex UV400 offers the maximum possible protection against UV rays. With its wide range of accessories, the multi-system is suitable for numerous applications and can be adapted to suit each and every one of them.



Scan for more information about the uvex i-gonomics product system.

force 4.0

Test method:
Torque measurement in the neck area*

Test result:
Torque = 0.4 Nm (IV 4.0)

Relief for the head and neck, reduced fatigue

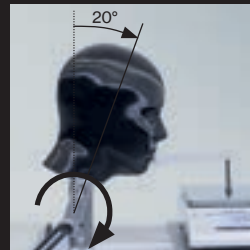

weight 3.9

Test method:
Weighing the face protection without hearing protection

Test result:
Product weight = 391 g (IW 3.9)

Comfortable fit, better performance



Relief index calculation:

The relief index is calculated from the average of the three index values (IV) – force, weight and climate – and ranges from 0 (= poor) to 5 (= optimum).

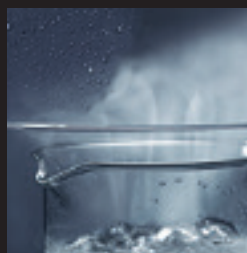

clima 4.8

Test method:
uvex benchmark "anti-fog" test

Test result:
Anti-fog performance = 29 points (IV 4.8)

Fog-free view, even in extreme climates



Visors and face protection

uvex pheos visor system

Perfect 'resting position' for the visor and hearing protection

The visor can be locked above the helmet shell when not required and the hearing protection can be folded back. Everything fits closely to the helmet and is perfectly balanced over the body's centre of gravity. This means the neck muscles are not placed under strain by any unnecessary weight, ensuring excellent wearer comfort and maximum freedom of movement.

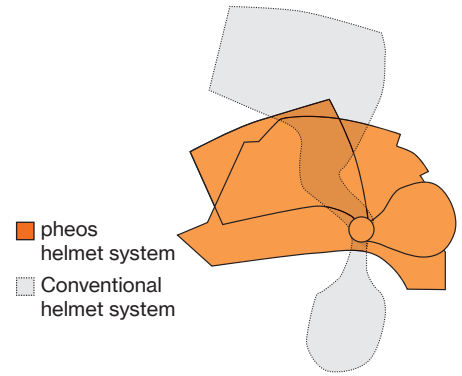

Reliable face protection

The anti-fog and scratch-resistant visor is made of high-quality polycarbonate that meet the highest optical quality class. The visor fits the helmet seamlessly, leaving no gaps. The injection-moulded transparent peak provides protection against any particles penetrating the inside of the visor.



| | | | |
|-------------------------|---|--|--|
| Art. no. | uvex pheos 9906002 | uvex pheos SLB 1 magnetic 9906005 | uvex pheos SLB 2 9906007 |
| Version | uvex supravision excellence with mechanical levers | uvex supravision excellence certified as Class 1 visor for protection from electrical arcs, with mechanical levers | uvex supravision excellence certified as Class 2 visor for protection from electrical arcs with mechanical levers and chin protection |
| Standard | EN 166, EN 170 | EN 166, EN 170 | EN 166, EN 170 |
| Frame | black W 166 3 8-2 9 B CE 0196 | black W 166 3 8-2 9 B CE 0196 | black W 166 3 8-2 9 B CE 0196 |
| Lens | PC clear UV 400 2C-1.2 W 1 B 9 KN CE 0196 | PC clear UV 400 2C-1.2 W 1 B 8-1-0 9 KN CE 0196 | PC blue UV 400 2C-1.2 W 1 B 8-2-0 9 KN CE 0196 |
| Order unit | PC, individually packed in polythene bags | PC, individually packed in polythene bags | PC, individually packed in polythene bags |
| Outer packaging | 24 PC per CT | 24 PC per CT | 24 PC per CT |
| Replacement lens | 9906013, individually packed in polythene bags | 9906012, individually packed in polythene bags | 9906017, individually packed in polythene bags |
| Art. no. | uvex pheos magnetic 9906003 | uvex pheos SLB 1 magnetic 9906006 | uvex pheos SLB 2 magnetic 9906008 |
| Version | uvex supravision excellence with magnetic levers | uvex supravision excellence certified as Class 1 visor for protection from electrical arcs, with magnetic levers | uvex supravision excellence certified as Class 2 visor for protection from electrical arcs with magnetic levers and chin protection |
| Standard | EN 166, EN 170 | EN 166, EN 170 | EN 166, EN 170 |
| Frame | black W 166 3 8-2 9 B CE 0196 | black W 166 3 8-2 9 B CE 0196 | black W 166 3 8-2 9 B CE 0196 |
| Lens | PC clear UV 400 2C-1.2 W 1 B 9 KN CE 0196 | PC clear UV 400 2C-1.2 W 1 B 8-1-0 9 KN CE 0196 | PC blue UV 400 2C-1.2 W 1 B 8-2-0 9 KN CE 0196 |
| Order unit | PC, individually packed in polythene bags | PC, individually packed in polythene bags | PC, individually packed in polythene bags |
| Outer packaging | 24 PC per CT | 24 PC per CT | 24 PC per CT |
| Replacement lens | 9906013, individually packed in polythene bags | 9906012, individually packed in polythene bags | 9906017, individually packed in polythene bags |

Visors and face protection

uvex pheos visor system

uvex pheos visor

- polycarbonate visors with uvex supravision excellence coating technology
- visor is anti-fog on the inside and exceptionally scratch- and chemical-resistant on the outside. The anti-fogging properties are permanent, even after repeated cleaning
- easy to clean thanks to non-stick nanotechnology
- available with two mounting options: mechanical levers or automatic magnetic locks
- visors 9906002 and 9906003 can be combined with the industrial protection helmets:
 - uvex pheos B-S-WR
 - uvex pheos E-S-WR
 - Helmet for working at height uvex pheos alpine (visor adapter art. no. 9790067 required)

- visors uvex pheos SLB 1 (9906005 and 9906006) and uvex pheos SLB 2 (9906007 and 9906008) can be combined with the uvex pheos E-S-WR industrial safety helmet
- lenses can be changed
- fulfils standards EN 166 and EN 170
- certified for areas of application 3 (liquids) and 9 (molten metal and hot solids)
- uvex pheos SLB 1 visors are certified in accordance with GS-ET 29 as Class 1 visors for protection from electrical arcs (4kA)
- uvex pheos SLB 2 visors are certified in accordance with GS-ET 29 as Class 2 visors for protection from electrical arcs (7kA)
- you can find the combination options on the next page (page 128)



Magnetic and mechanical locking system

All visors are pre-assembled with a helmet adapter. This is clicked into the side helmet slot and remains permanently attached there.

With the magnetic locking system, the attachment parts, visor and earmuffs can be removed easily at any time without having to remove the helmet. The visor is released with a click of the lateral locking system. When reassembled, the parts automatically snap back into place. This allows the helmet to remain comfortably on your head.

In the case of the mechanical locking system, the earmuffs can be removed at any time via a bayonet lock. The mechanical visor remains permanently attached to the helmet.

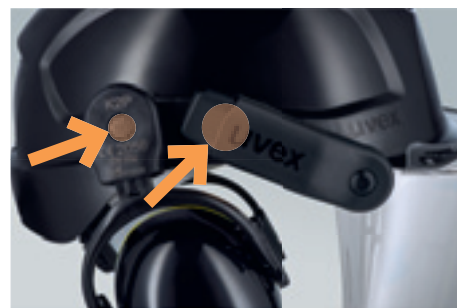

Magnetic
locking system for visor and earmuffs











Mechanical
locking system for visor and earmuffs

Visors and face protection

Combination options and accessories

Combination options uvex pheos visors

| | Art. no. | Visor frame | Visor | Protection | Suitable helmets | Earmuffs |
|---|----------|-------------|---|--|--|---|
|  | 9906002 | mechanical | polycarbonate, clear | against mechanical influences (e.g. sparks, splinters) | all uvex pheos helmets with short brim | 2600214  |
|  | 9906003 | magnetic | polycarbonate, clear | against mechanical influences (e.g. sparks, splinters) | uvex pheos alpine (with visor adapter 9790067) | 2600215  |
|  | 9906005 | mechanical | polycarbonate, clear with UV absorber | against electrical arcs up to 4 kA (kiloamperes) | uvex pheos E-S-WR | 2600214 |
|  | 9906006 | magnetic | polycarbonate, clear with UV absorber | against electrical arcs up to 4 kA (kiloamperes) | | 2600215 |
|  | 9906007 | mechanical | polycarbonate, blue with UV absorber and chin section | against electrical arcs up to 7 kA (kiloamperes) | | 2600214 |
|  | 9906008 | magnetic | polycarbonate, blue with UV absorber and chin section | against electrical arcs up to 7 kA (kiloamperes) | | 2600215 |



9790067



9790074



9790078



9954362

uvex pheos visor system accessories

| Visor adapter | |
|-------------------|--|
| Art. no. | 9790067 |
| Version | for combining with the helmet for working at height uvex pheos alpine for inserting on the inside of the visor's face cover (visor not included) |
| Order unit | PC, individually packed in polythene bags |

| Helmet adapter | |
|-------------------|--|
| Art. no. | 9790078 |
| Version | helmet adapter for use with uvex pheos K2P magnet earmuffs (2600215) without visor, is only required if no visor is used |
| Order unit | PR, individually packed in polythene bags |

| Sunglare filter/rain cover | |
|----------------------------|---|
| Art. no. | 9790078 |
| Version | to protect against sun and rain, for insertion on the inside of the face cover of the visor, cannot be combined with the visors uvex pheos SLB 1 and uvex pheos SLB 2 |
| Order unit | PC, individually packed in polythene bags |

| Microfibre case | |
|-------------------|--|
| Art. no. | 9954362 |
| Version | cloth bag to store and transport uvex visors and uvex helmets, black |
| Order unit | PC, loose |

Visors and face protection

9790 · 9725 · 9726 · Forestry worker visor



9790048



9790047



9924010

uvex 9790

- robust polycarbonate visor for uvex industrial safety helmets and uvex helmet earmuffs 3200H, K1H and K2H
- for use during electrical work, a suitable electrician's helmet and dielectric helmet earmuffs must be used
- visor lens, helmet bracket and adapter must be ordered as individual parts
- additional adapters (art. no. 9924010) are required for the helmet and visor combination (without helmet earmuffs)

► helmet, helmet bracket and earmuffs are not included.



| | |
|-----------------|---|
| Lens | |
| Art. no. | 9790048 |
| Version | uncoated |
| | Short circuit electric arc classification Class 1 |
| | Fixed on helmet bracket 9790047 |
| Standard | EN 166, EN 170 |
| Lens | PC clear, UV 400 |
| | 2C-1.2 W 1 B 89 CE |
| Order unit | PC, individually packed in polythene bags |
| Outer packaging | 100 PC per CT |

| | | |
|-----------------|---|--|
| | Helmet bracket | Adapter |
| Art. no. | 9790047 | 9924010 |
| Version | Helmet bracket for visor 9790 (9790048) | Adapter for attaching without earmuffs |
| Frame | black | |
| | EN 166 389 B CE | |
| Order unit | PC, individually packed in polythene bags | |
| Outer packaging | 90 PC per CT | 500 PC per CT |



9725514
9726014

uvex 9725 · uvex 9726

- polycarbonate and cellulose acetate visors with adapters for attaching on the side helmet slots
- easy to change lenses
- not combinable with earmuffs
- suitable for helmets uvex airwing and uvex superboss

► Helmet not included!

| | | |
|------------------|---|--------------------------|
| Visors | | |
| Art. no. | 9725514 | 9726014 |
| Replacement lens | 9050517 | 9723017 |
| Version | anti-fog on the inside | uncoated |
| | Material thickness: 1 mm | Material thickness: 1 mm |
| Standard | EN 166, EN 170 | EN 166, EN 170 |
| Frame | black | black |
| | W 166 3-F DIN CE 0196 | W 166 3-B DIN CE 0196 |
| Lens | CA clear, UV 380 | PC clear, UV 400 |
| | W 1 FN DIN CE | W 1 B DIN CE |
| Order unit | PC, individually packed in polythene bags | |
| Outer packaging | 20 PC per CT | 20 PC per CT |



uvex pheos forestry worker visor

- metal mesh visor for forestry work
- suitable for helmet uvex pheos ABS
- lens certification: W EN 1731:2006-F

Further information can be found on page 110/111.

uvex pheos faceguard

Face protection system

Innovative face protection without helmet. The system consists of a height- and width-adjustable head mount and a high-quality polycarbonate visor. The visor can be locked in any position and features uvex coating technology for a long field of vision and fog-free view. The earmuffs can be attached and removed quickly using a rotating mechanism. This allows you to customise the multi-system to suit your needs.



The uvex multi-system in detail



Centre of gravity over the middle of the head
Relieves the neck muscles and spine

Individual height adjustment of system for a custom fit

Highly adjustable wheel ratchet system with wide neck piece
infinitely variable single-handed width adjustment with wheel ratchet system for a customised, comfortable fit.
Suitable for head sizes 52–64



Suspension harness and sweatband
Adapts comfortably to the head shape

Multiposition lockable visor
Lenses can be changed

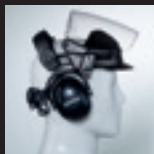

Removable earmuffs
For additional protection

Visor made from robust polycarbonate
Scratch-resistant on the outside Anti-fog on the inside UV 400 protection



The benefits of the uvex pheos faceguard at a glance:

- fully pre-assembled face protection system — ready to use at any time
- wide field of vision with the highest optical quality
- sturdy polycarbonate visor with anti-fog and scratch-resistant uvex supravision excellence coating
- low weight and balanced centre of gravity to relieve the spine
- expandable system with high modularity
- replaceable individual parts
- comfortable fit even with glasses and respirators



Further information can be found at uvex-safety.com/en/pheosfaceguard (or scan the QR code).

uvex pheos faceguard

Face protection system

Designed to protect the face and neck

The uvex pheos faceguard has been ergonomically designed. The face protection system has been designed to evenly distribute the weight across the body's centre of gravity. The low weight and ergonomic centre of gravity supports a natural head posture, minimising strain on the neck and back. The narrow design and wide field of vision help to support the natural posture of the head and neck.



Did you know that our neck is already exposed to four to five kilograms at a zero degree angle of inclination? The further the incline, which is often the case in industries such as construction, the greater the strain.

Learn more in our uvex experts blog at [uvex safety.com/blog](https://uvex.com/blog)



9790211



9790212

(Conformity assessment not yet completed)

| | | |
|-------------------|---|--|
| Art. no. | uvex pheos faceguard 9790211 | uvex pheos faceguard with hearing protection 9790212 |
| Version | Pre-assembled system for head sizes 52-64 cm, Polycarbonate lens, uvex supravision excellence coating, Without hearing protection | Pre-assembled system for head sizes 52-64 cm, Polycarbonate lens, uvex supravision excellence coating, With earmuffs K1P (SNR: 28 dB), further information can be found on page 99 |
| Standard | EN 166, EN 170 | EN 166, EN 170, EN 352 |
| Frame | W 166 39B CE | W 166 39B CE |
| Lens | PC, clear, UV 400 | PC, clear, UV 400 |
| Order unit | 2C-1.2 W 1 B 9 KN CE 0196 PC, individually packed in CT | 2C-1.2 W 1 B 9 KN CE 0196 PC, individually packed in CT |

Accessories



9906013



9790074



2600216

| | | | | | |
|-------------------|---|--|--|---|--|
| Art. no. | replacement suspension harness 9760107 | replacement sweatband 9760108 | replacement lens visor 9906013 | sun protection 9790074 | hearing protection earplugs K1P 2600216 |
| Version | Plastic suspension harness for head sizes 52-64 cm | Textile | Polycarbonate lens uvex supravision excellence coating | Protects against sun and rain is inserted on the visor | Earmuffs for uvex pheos faceguard SNR 28 dB |
| Order unit | PC, individually packed in polythene bags | PC, individually packed in polythene bags | PC, individually packed in polythene bags | PC, individually packed in polythene bags | PR, in pairs in CT |

Safety Helmets

uvex Visors



9705014



9707014



9302510



9706514



9708514



9301544

uvex 9705 · uvex 9706

- cellulose acetate visor with integrated forehead cover
- easy to change lenses
- cannot be combined with safety helmets
- flip-up mechanism with continuous adjustment
- head size can be easily adjusted using a twist lock

uvex 9707 · uvex 9708

- cellulose acetate visor with integrated forehead cover and additional protective cap made from impact-resistant polystyrene
- easy to change lenses
- flip-up mechanism with continuous adjustment
- head size can be easily adjusted using a twist lock

uvex goggles with helmet bracket

- ▶ Helmet and earmuffs not included!
- ▶ Additional adapters are required for attaching the goggles without earmuffs:
Art. no. 9924010

| | visor 9705 | visor 9706 | visor 9707 | visor 9708 |
|-------------------------|---|------------------------|-----------------------|------------------------|
| Art. no. | 9705014 | 9706514 | 9707014 | 9708514 |
| Version | uncoated | anti-fog on the inside | uncoated | anti-fog on the inside |
| Standard | EN 166, EN 170 | EN 166, EN 170 | EN 166, EN 170 | EN 166, EN 170 |
| Frame | black | black | black | black |
| | W 166 3-F DIN CE 0196 | W 166 3-F DIN CE 0196 | W 166 3 F DIN CE 0196 | W 166 3 F DIN CE 0196 |
| Lens | CA clear, UV 380 | CA clear, UV 380 | CA clear, UV 380 | CA clear, UV 380 |
| | W 1 F DIN CE | W 1 FN DIN CE | W 1 F DIN CE | W 1 F DIN CE |
| Order unit | PC, individually packed in polythene bags | | | |
| Outer packaging | 15 PC per CT | 15 PC per CT | 10 PC per CT | 10 PC per CT |
| Replacement lens | 9060017 | 9050517 | 9060017 | 9050517 |

| uvex ultrasonic | |
|---------------------------------|--|
| Art. no. | 9302510 |
| Version | uvex supravision extreme reduced ventilation |
| Standard | EN 166, EN 170 |
| Frame | blue, grey |
| | W 166 34 B CE |
| Lens | PC clear, UV 400 |
| | 2C-12 W 1 B KN DIN CE |
| Order quantity multiples | 4 PC |

| uvex ultravision | |
|---------------------------------|---------------------|
| Art. no. | 9301544 |
| Version | anti-fog |
| Standard | EN 166, EN 170 |
| Frame | transparent grey |
| | W 166 34 F CE |
| Lens | CA clear, UV 380 |
| | 2-1.2 W 1 FN DIN CE |
| Order quantity multiples | 4 PC |

Accessories

uvex pheos



| | uvex pheos B | uvex pheos B-WR | uvex pheos B-S-WR | uvex pheos E | uvex pheos E-WR | uvex pheos E-S-WR | uvex pheos IES | uvex 9780 antistatisch | uvex pheos alpine |
|---|--------------|-----------------|-------------------|--------------|-----------------|-------------------|----------------|------------------------|-------------------|
| 9760000 Conventional suspension harness | ■ | ■ | ■ | ■ | ■ | ■ | ■ | - | - |
| 9760001 Suspension harness with rotating size adjusters | ■ | ■ | ■ | - | - | - | ■ | - | - |
| 9760011 Suspension harness for pheos alpine | - | - | - | - | - | - | - | - | ■ |
| 9760012 Suspension harness for uvex pheos E-WR | ■ | ■ | ■ | ■ | ■ | ■ | ■ | - | - |
| 9772001 Suspension harness IES | ■ | ■ | ■ | - | - | - | ■ | - | - |
| 9780001 Suspension harness with rotating size adjusters | ■ | ■ | ■ | - | - | - | ■ | ■ | - |
| 9760009 Sweatband uvex pheos alpine and uvex pheos E-WR | ■ | ■ | ■ | ■ | ■ | ■ | ■ | - | ■ |
| 9760007 Sweatband IES | - | - | - | - | - | - | ■ | - | - |
| 9760005 Sweatband, synthetic leather | ■ | ■ | ■ | ■ | ■ | ■ | - | ■ | - |
| 9790035 Leather chin straps IES | ■ | ■ | ■ | - | - | - | ■ | - | - |
| 9790005 Leather chin straps | ■ | ■ | ■ | - | - | - | - | - | ■ |
| 9790021 Forked chin straps | ■ | ■ | ■ | ■ | ■ | ■ | ■ | ■ | - |
| 9790023 Pen holder | ■ | ■ | ■ | ■ | ■ | ■ | ■ | - | - |
| 9772002 Mount | - | - | - | - | - | - | ■ | - | - |
| 9790022 Goggles clip, chin strap clip | ■ | ■ | ■ | ■ | ■ | ■ | ■ | - | ■ |
| 9790065 Winter cap, hi-viz yellow | ■ | ■ | ■ | ■ | ■ | ■ | ■ | - | ■ |
| 9790066 Balaclava | ■ | ■ | ■ | ■ | ■ | ■ | ■ | - | ■ |
| 9790068 Winter cap, hi-viz orange | ■ | ■ | ■ | ■ | ■ | ■ | ■ | - | ■ |
| 9790075 Neck protection, orange | ■ | ■ | ■ | ■ | ■ | ■ | ■ | - | ■ |
| 9790076 Neck protection, yellow | ■ | ■ | ■ | ■ | ■ | ■ | ■ | - | ■ |
| 9790086 uvex cooling neck protection | ■ | ■ | ■ | ■ | ■ | ■ | ■ | - | ■ |
| 9790106 Business card holder | ■ | ■ | ■ | ■ | ■ | ■ | ■ | - | ■ |
| 9906002 uvex pheos visor | - | - | ■ | - | - | ■ | - | - | ■ |
| 9906003 uvex pheos visor SLB1 | - | - | - | - | - | ■ | - | - | - |
| 9906005 uvex pheos visor SLB2 | - | - | - | - | - | ■ | - | - | - |
| 9906007 uvex pheos visor SLB2 | - | - | - | - | - | ■ | - | - | - |
| 9906008 uvex pheos visor SLB2 | - | - | - | - | - | ■ | - | - | - |
| 2600201 uvex K1H | ■ | ■ | ■ | - | - | - | ■ | - | ■ |
| 2600202 uvex K2H | ■ | ■ | ■ | - | - | - | ■ | - | ■ |
| 9790062 LED head torch pheos Lights | ■ | ■ | ■ | - | - | - | ■ | - | ■ |
| 9790063 LED head torch pheos Lights EX | ■ | ■ | ■ | - | - | - | ■ | ■ | ■ |
| 9790029 LED head torch KS-6001 Duo | ■ | ■ | ■ | - | - | - | ■ | - | ■ |
| 9790213 Suprabeam V3air rechargeable | ■ | ■ | ■ | - | - | - | ■ | - | ■ |
| 9790064 LED head torch u-cap sport | ■ | ■ | ■ | ■ | ■ | ■ | ■ | - | ■ |
| 9790069 uvex pheos helmet adapter | ■ | ■ | ■ | ■ | ■ | ■ | ■ | - | ■ |

■ supplied as standard

■ compatible

- not compatible

Accessories

uvex airwing · uvex super boss · uvex thermo boss



| | uvex airwing B | uvex airwing B-WR | uvex airwing B-S | uvex airwing B-S-WR | uvex super boss | uvex thermo boss |
|---------|---|-------------------|------------------|---------------------|-----------------|------------------|
| 9760000 | Conventional suspension harness | ■ | ■ | ■ | - | - |
| 9760001 | Suspension harness with rotating size adjusters | ■ | ■ | ■ | - | - |
| 9790000 | Suspension harness for uvex super boss / uvex thermo boss | - | - | - | ■ | ■ |
| 9760005 | Sweatband | ■ | ■ | ■ | - | - |
| 9790004 | Sweatband for uvex super boss / uvex thermo boss | - | - | - | ■ | ■ |
| 9790005 | Leather chin straps | ■ | ■ | ■ | ■ | ■ |
| 9790007 | Forked chin straps | ■ | ■ | ■ | ■ | ■ |
| 9790065 | Winter cap, yellow | ■ | ■ | ■ | ■ | ■ |
| 9790066 | Balaclava | ■ | ■ | ■ | ■ | ■ |
| 9790068 | Winter cap, orange | ■ | ■ | ■ | ■ | ■ |
| 9790075 | Neck protection, orange | ■ | ■ | ■ | ■ | ■ |
| 9790076 | Neck protection, yellow | ■ | ■ | ■ | ■ | ■ |
| 9790086 | uvex cooling neck protection | ■ | ■ | ■ | ■ | ■ |
| 9790047 | Helmet bracket uvex 9790 | ■ | ■ | ■ | - | - |
| 9790048 | Visor lens, PC | ■ | ■ | ■ | - | - |
| 2600201 | uvex K1H | ■ | ■ | ■ | ■ | ■ |
| 2600202 | uvex K2H | ■ | ■ | ■ | ■ | ■ |

■ supplied as standard

■ compatible

- not compatible



Safety helmets to match your corporate identity

Individual safety helmets

uvex gives you the option to customise all uvex helmets and bump caps so that your employees' equipment matches your corporate identity specifications.

Please contact the uvex service centre with your requests at any time.

Tel. +49 911 9736-0 · Email: Individualisierung@uvex.de

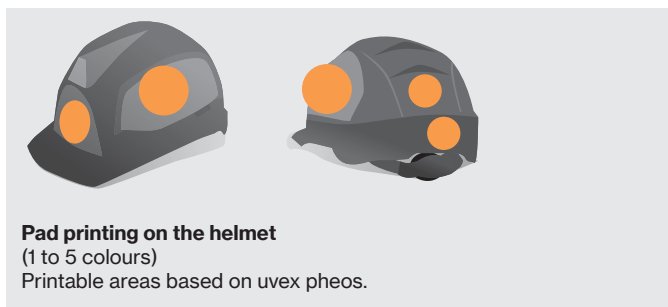

Pad printing on the helmet

(1 to 5 colours)

Printable areas based on uvex pheos.

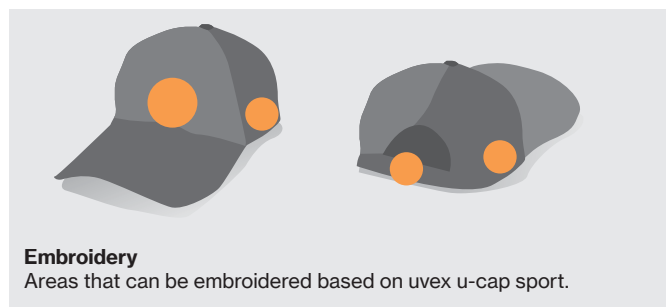

Embroidery

Areas that can be embroidered based on uvex u-cap sport.

| Customisation on the helmet | uvex pheos, uvex airwing, uvex superboss, uvex thermoboss | uvex pheos alpine |
|--|--|--------------------------------------|
| Special colour | from 300 units with supplemental charge from 600 units no additional cost | from 600 units no additional cost |
| new variant: | | |
| – existing colour as a variant, electrician or chemist | from 300 units | |
| – existing colour with shortened brim | from 100 units | |
| – existing helmet, other interior, with chin strap | from 25 units | |
| Finish: Printed, sticker, reflex set | from 25 units reorder quantity: 25 units | |

| Customisation of bump caps | |
|------------------------------|------------------|
| Special colour | from 1,000 units |
| new variant: | |
| – with existing colour | from 600 units |
| Finish: Embroidered, printed | from 25 units |

- Please note the following conditions:
- minimum order value 25 caps
- reorder quantity: 25 units
- number of colours to be embroidered: up to 14
- textile cap in special colour: from 1000 units
- vector file (.eps, .ai) and image file (.jpg, .pdf) required as template

How individual can you be?

We will be happy to advise you on the technical options for customising our safety helmets.

uvex u-cap sport

Guaranteed head protection with a sporty design

Reliable protection that looks good: uvex u-cap sport is an innovative baseball bump cap in accordance with Norm EN 812. The ergonomically shaped shell with integrated shock-absorbing elements ensures safety and optimal comfort. To give your team a uniform appearance, this model is also available as a standard baseball cap for employees working in environments where head protection is not compulsory.

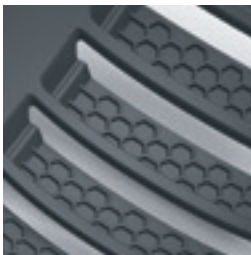

Integrated shock-absorbing elements with honeycomb structure

The specially developed honeycomb structure of the cap with integrated shock-absorbing elements ensures complete protection in accordance with EN 812.



Armadillo design gives flexibility

The armadillo design of the uvex u-cap sport provides additional flexibility and ergonomically adapts to different head shapes and sizes. The extended cut-out near the ear makes it easier to wear earmuffs.



Continuously adjustable

The uvex u-cap sport can be quickly and easily fitted to the head using the adjustable velcro fastening.



Magnetic head torch

- Simple to use: magnetic fixing enables easy attachment and removal from u-cap sport
- The beam can be directed in multiple directions through a moving joint, ensuring optimal illumination
- Switch between various beam types

uvex u-cap sport
A wide range for many applications



LED lamp uvex u-cap sport, suitable for all u-cap sport variants available on page 119.

uvex u-cap sport

| uvex u-cap sport | | | | | | |
|------------------------|---|--------------|--------------|---|--------------|--------------|
| Art. no. | 9794409 | 9794403 | 9794404 | 9794442 | 9794422 | 9794424 |
| Version | with short brim (4 cm), hard case made of ABS, textile cap made of cotton | | | with short brim (4 cm) and mesh webbing suspension harness, hard case made of ABS, textile cap made of cotton | | |
| Standard | EN 812 | EN 812 | EN 812 | EN 812 | EN 812 | EN 812 |
| Colour | black | black | black | black | black | black |
| Sizes | 52 to 54 cm | 55 to 59 cm | 60 to 63 cm | 52 to 54 cm | 55 to 59 cm | 60 to 63 cm |
| Order unit | PC | PC | PC | PC | PC | PC |
| Outer packaging | 60 PC per CT | 60 PC per CT | 60 PC per CT | 60 PC per CT | 60 PC per CT | 60 PC per CT |
| Art. no. | 9794400 | 9794401 | 9794402 | 9794443 | 9794423 | 9794425 |
| Version | with long brim (7 cm), hard case made of ABS, textile cap made of cotton | | | with long brim (7 cm) and mesh webbing suspension harness, hard case made of ABS, textile cap made of cotton | | |
| Standard | EN 812 | EN 812 | EN 812 | EN 812 | EN 812 | EN 812 |
| Colour | black | black | black | black | black | black |
| Sizes | 52 to 54 cm | 55 to 59 cm | 60 to 63 cm | 52 to 54 cm | 55 to 59 cm | 60 to 63 cm |
| Order unit | PC | PC | PC | PC | PC | PC |
| Outer packaging | 60 PC per CT | 60 PC per CT | 60 PC per CT | 60 PC per CT | 60 PC per CT | 60 PC per CT |

uvex u-cap sport suspension harness

| uvex u-cap sport suspension harness | |
|-------------------------------------|--|
| Art. no. | 9794415 |
| Version | soft, comfortable mesh webbing suspension harness increased wearer comfort in uvex u-cap sport bump caps |
| Standard | EN 812 |
| Colour | black |
| Sizes | unisize |
| Order unit | PC |
| Outer packaging | 60 PC per CT |

Baseball cap

| Baseball cap | | |
|------------------------|--|---|
| Art. no. | 9794110 | 9794111 |
| Version | with long brim (7 cm) without hard shell element | with short brim (4 cm) without hard shell element |
| Colour | black | black |
| Sizes | 55 to 63 cm | 55 to 63 cm |
| Order unit | PC | PC |
| Outer packaging | 60 PC per CT | 60 PC per CT |

uvex u-cap

uvex u-cap sport · uvex u-cap sport vent · uvex u-cap sport hi-viz



9794407
9794408



9794430 9794444
9794420 9794416
9794421 9794417



9794480
9794481
9794482



9794490
9794491
9794492



LED lamp uvex u-cap sport, suitable for all u-cap sport variants available on page 119.

uvex u-cap sport

| uvex u-cap sport | | |
|------------------------|--|--------------|
| Art. no. | 9794407 | 9794408 |
| Version | with long brim (7 cm), hard case made of ABS, textile cap made of cotton | |
| Standard | EN 812 | EN 812 |
| Colour | navy blue | navy blue |
| Sizes | 55 to 59 cm | 60 to 63 cm |
| Order unit | PC | PC |
| Outer packaging | 60 PC per CT | 60 PC per CT |

uvex u-cap sport vent

| uvex u-cap sport vent | | | |
|------------------------|--|--------------|--------------|
| Art. no. | 9794430 | 9794420 | 9794421 |
| Version | with short brim (4 cm), hard case made of ABS, textile cap made of cotton and mesh fibre | | |
| Standard | EN 812 | EN 812 | EN 812 |
| Colour | black | black | black |
| Sizes | 52 to 54 cm | 55 to 59 cm | 60 to 63 cm |
| Order unit | PC | PC | PC |
| Outer packaging | 60 PC per CT | 60 PC per CT | 60 PC per CT |
| Art. no. | 9794444 | 9794416 | 9794417 |
| Version | with short brim (4 cm) and mesh webbing and mesh webbing interior, ABS hard shell, textile cap made of cotton and mesh fibre | | |
| Standard | EN 812 | EN 812 | EN 812 |
| Colour | black | black | black |
| Sizes | 52 to 54 cm | 55 to 59 cm | 60 to 63 cm |
| Order unit | PC | PC | PC |
| Outer packaging | 60 PC per CT | 60 PC per CT | 60 PC per CT |

uvex u-cap sport hi-viz

| uvex u-cap sport hi-viz | | | | | | |
|-------------------------|---|---------------|---------------|---------------|---------------|---------------|
| Art. no. | 9794482 | 9794480 | 9794481 | 9794492 | 9794490 | 9794491 |
| Version | with short brim (4 cm), ABS hard shell, textile cap made of cotton in fluorescent colours, according to requirements with EN 471 – increased visibility and security for the user | | | | | |
| Standard | EN 812 | EN 812 | EN 812 | EN 812 | EN 812 | EN 812 |
| Colour | hi-viz yellow | hi-viz yellow | hi-viz yellow | hi-viz orange | hi-viz orange | hi-viz orange |
| Sizes | 52 to 54 cm | 55 to 59 cm | 60 to 63 cm | 52 to 54 cm | 55 to 59 cm | 60 to 63 cm |
| Order unit | PC | PC | PC | PC | PC | PC |
| Outer packaging | 60 PC per CT | 60 PC per CT | 60 PC per CT | 60 PC per CT | 60 PC per CT | 60 PC per CT |

Safety Helmets

Overview

| Art. no. | Name | Description | Colour | Page |
|----------|---------------------|---|------------|---------|
| 9050517 | Accessories | Replacement lens, CA, non-fogging | clear | 129/132 |
| 9060017 | Accessories | Replacement lens, CA | clear | 132 |
| 9301544 | uvex ultravision | Wide-vision goggles with helmet bracket, | grey | 132 |
| 9302510 | uvex ultrasonic | Wide-vision goggles with helmet bracket, | blue, grey | 132 |
| 9705014 | Accessories | Cellulose acetate protective visor | clear | 132 |
| 9706514 | Accessories | Antifog cellulose acetate protective visor, | clear | 132 |
| 9707014 | Accessories | Cellulose acetate protective visor | clear | 132 |
| 9708514 | Accessories | Antifog cellulose acetate protective visor, | clear | 132 |
| 9723017 | Accessories | Replacement lens, PC | clear | 129 |
| 9725514 | Accessories | Antifog cellulose acetate visor | clear | 129 |
| 9726014 | Accessories | Polycarbonate visor | clear | 129 |
| 9750020 | uvex super boss | Safety helmet | white | 114 |
| 9750120 | uvex super boss | Safety helmet | yellow | 114 |
| 9750520 | uvex super boss | Safety helmet | blue | 114 |
| 9754000 | uvex thermo boss | Safety helmet | white | 115 |
| 9754100 | uvex thermo boss | Safety helmet | yellow | 115 |
| 9754300 | uvex thermo boss | Safety helmet | red | 115 |
| 9760000 | Accessories | Conventional suspension harness | | 117 |
| 9760001 | Accessories | Suspension harness with rotating size adjusters | | 117 |
| 9760005 | Accessories | Sweatband, synthetic leather | | 117 |
| 9760007 | Accessories | Sweatband, textile/foam material | | 117 |
| 9760009 | Accessories | Sweatband pheos ABS | | 111/117 |
| 9760011 | uvex pheos alpine | Suspension harness | | 117 |
| 9760012 | uvex pheos E-WR | Suspension harness | | 117 |
| 9760106 | Accessories | Replacement suspension harness pheos ABS | | 111 |
| 9760107 | Accessories | Suspension harness pheos faceguard | | 131 |
| 9760108 | Accessories | Sweatband for suspension harness | | 131 |
| 9762020 | uvex airwing B | Safety helmet | white | 114 |
| 9762021 | uvex airwing B-S | Safety helmet | white | 115 |
| 9762030 | uvex airwing B-WR | Safety helmet | white | 114 |
| 9762031 | uvex airwing B-S-WR | Safety helmet | white | 115 |
| 9762120 | uvex airwing B | Safety helmet | yellow | 114 |
| 9762121 | uvex airwing B-S | Safety helmet | yellow | 115 |
| 9762130 | uvex airwing B-WR | Safety helmet | yellow | 114 |
| 9762131 | uvex airwing B-S-WR | Safety helmet | yellow | 115 |
| 9762220 | uvex airwing B | Safety helmet | orange | 114 |
| 9762221 | uvex airwing B-S | Safety helmet | orange | 115 |
| 9762230 | uvex airwing B-WR | Safety helmet | orange | 114 |
| 9762231 | uvex airwing B-S-WR | Safety helmet | orange | 115 |
| 9762320 | uvex airwing B | Safety helmet | red | 114 |
| 9762321 | uvex airwing B-S | Safety helmet | red | 115 |
| 9762330 | uvex airwing B-WR | Safety helmet | red | 114 |
| 9762331 | uvex airwing B-S-WR | Safety helmet | red | 115 |
| 9762420 | uvex airwing B | Safety helmet | green | 114 |
| 9762421 | uvex airwing B-S | Safety helmet | green | 115 |
| 9762430 | uvex airwing B-WR | Safety helmet | green | 114 |
| 9762431 | uvex airwing B-S-WR | Safety helmet | green | 115 |
| 9762520 | uvex airwing B | Safety helmet | blue | 114 |
| 9762521 | uvex airwing B-S | Safety helmet | blue | 115 |
| 9762530 | uvex airwing B-WR | Safety helmet | blue | 114 |
| 9762531 | uvex airwing B-S-WR | Safety helmet | blue | 115 |
| 9762920 | uvex airwing B | Safety helmet | black | 114 |
| 9770020 | uvex pheos E | Safety helmet | white | 108 |
| 9770026 | uvex pheos E | Safety helmet with reflective sticker | white | 109 |
| 9770030 | uvex pheos E-WR | Safety helmet | white | 108 |
| 9770031 | uvex pheos E-S-WR | Safety helmet | white | 108 |
| 9770036 | uvex pheos E-WR | Safety helmet with reflective sticker | white | 109 |
| 9770120 | uvex pheos E | Safety helmet | yellow | 108 |

| Art. no. | Name | Description | Colour | Page |
|----------|-----------------------|---------------------------------------|-----------|------|
| 9770126 | uvex pheos E | Safety helmet with reflective sticker | yellow | 109 |
| 9770130 | uvex pheos E-WR | Safety helmet | yellow | 108 |
| 9770131 | uvex pheos E-S-WR | Safety helmet | yellow | 108 |
| 9770136 | uvex pheos E-WR | Safety helmet with reflective sticker | yellow | 109 |
| 9770230 | uvex pheos E-WR | Safety helmet | orange | 108 |
| 9770231 | uvex pheos E-S-WR | Safety helmet | orange | 108 |
| 9770330 | uvex pheos E-WR | Safety helmet | red | 108 |
| 9770331 | uvex pheos E-S-WR | Safety helmet | red | 108 |
| 9770430 | uvex pheos E-WR | Safety helmet | green | 108 |
| 9770431 | uvex pheos E-S-WR | Safety helmet | green | 108 |
| 9770530 | uvex pheos E-WR | Safety helmet | blue | 108 |
| 9770531 | uvex pheos E-S-WR | Safety helmet | blue | 108 |
| 9770830 | uvex pheos E-WR | Safety helmet | dark grey | 108 |
| 9770832 | uvex pheos E-S-WR | Safety helmet | dark grey | 108 |
| 9770931 | uvex pheos E-S-WR | Safety helmet | black | 108 |
| 9772001 | Accessories | Suspension harness IES | | 117 |
| 9772002 | Accessories | Mount | | 118 |
| 9772020 | uvex pheos B | Safety helmet | white | 107 |
| 9772026 | uvex pheos B | Safety helmet with reflective sticker | white | 109 |
| 9772030 | uvex pheos B-WR | Safety helmet | white | 107 |
| 9772031 | uvex pheos B-S-WR | Safety helmet | white | 107 |
| 9772035 | uvex pheos B-WR | Safety helmet with reflective sticker | white | 109 |
| 9772038 | uvex pheos B-S-WR | Safety helmet with reflective sticker | white | 109 |
| 9772040 | uvex pheos IES | Safety helmet | white | 106 |
| 9772071 | uvex pheos ABS B-S-WR | Safety helmet | white | 111 |
| 9772120 | uvex pheos B | Safety helmet | yellow | 107 |
| 9772126 | uvex pheos B | Safety helmet with reflective sticker | yellow | 109 |
| 9772130 | uvex pheos B-WR | Safety helmet | yellow | 107 |
| 9772131 | uvex pheos B-S-WR | Safety helmet | yellow | 107 |
| 9772137 | uvex pheos B-S-WR | Safety helmet with reflective sticker | yellow | 109 |
| 9772138 | uvex pheos B-WR | Safety helmet with reflective sticker | yellow | 109 |
| 9772140 | uvex pheos IES | Safety helmet | yellow | 106 |
| 9772171 | uvex pheos ABS B-S-WR | Safety helmet | yellow | 111 |
| 9772220 | uvex pheos B | Safety helmet | orange | 107 |
| 9772226 | uvex pheos B | Safety helmet with reflective sticker | orange | 109 |
| 9772230 | uvex pheos B-WR | Safety helmet | orange | 107 |
| 9772236 | uvex pheos B-WR | Safety helmet with reflective sticker | orange | 109 |
| 9772240 | uvex pheos IES | Safety helmet | orange | 106 |
| 9772271 | uvex pheos ABS B-S-WR | Safety helmet | orange | 111 |
| 9772320 | uvex pheos B | Safety helmet | red | 107 |
| 9772326 | uvex pheos B | Safety helmet with reflective sticker | red | 109 |
| 9772330 | uvex pheos B-WR | Safety helmet | red | 107 |
| 9772332 | uvex pheos B-S-WR | Safety helmet | red | 107 |
| 9772340 | uvex pheos IES | Safety helmet | red | 106 |
| 9772371 | uvex pheos ABS B-S-WR | Safety helmet | red | 111 |
| 9772430 | uvex pheos B-WR | Safety helmet | green | 107 |
| 9772520 | uvex pheos B | Safety helmet | blue | 107 |
| 9772526 | uvex pheos B | Safety helmet with reflective sticker | red | 109 |
| 9772530 | uvex pheos B-WR | Safety helmet | blue | 107 |
| 9772531 | uvex pheos B-S-WR | Safety helmet | blue | 107 |
| 9772537 | uvex pheos B-S-WR | Safety helmet with reflective sticker | blue | 109 |
| 9772538 | uvex pheos B-WR | Safety helmet with reflective sticker | blue | 109 |
| 9772540 | uvex pheos IES | Safety helmet | blue | 106 |
| 9772832 | uvex pheos B-S-WR | Safety helmet | dark grey | 107 |
| 9772920 | uvex pheos B | Safety helmet | black | 107 |
| 9772926 | uvex pheos B | Safety helmet with reflective sticker | black | 109 |
| 9772930 | uvex pheos B-WR | Safety helmet | black | 107 |
| 9772932 | uvex pheos B-S-WR | Safety helmet | black | 107 |



Safety Helmets

Overview

| Art. no. | Name | Description | Colour | Page |
|----------|-------------------------|---|---------------|---------|
| 9772936 | uvex pheos B-WR | Safety helmet with reflective sticker | black | 109 |
| 9773050 | uvex pheos alpine | Safety helmet | white | 113 |
| 9773150 | uvex pheos alpine | Safety helmet | yellow | 113 |
| 9773250 | uvex pheos alpine | Safety helmet | orange | 113 |
| 9773350 | uvex pheos alpine | Safety helmet | red | 113 |
| 9773450 | uvex pheos alpine | Safety helmet | green | 113 |
| 9773550 | uvex pheos alpine | Safety helmet | blue | 113 |
| 9773950 | uvex pheos alpine | Safety helmet | black | 113 |
| 9774236 | uvex pheos | Forestry | yellow | 111 |
| 9774237 | uvex pheos | Forestry | orange | 111 |
| 9774238 | uvex pheos | Forestry | red | 111 |
| 9780001 | Accessories | Suspension harness with rotating size adjusters | | 117 |
| 9780020 | uvex 9780 antistatic | Safety helmet | white | 109 |
| 9780030 | uvex 9780 antistatic-WR | Safety helmet | white | 109 |
| 9780550 | uvex 9780 antistatic-WR | Safety helmet | sky blue | 109 |
| 9790000 | Accessories | Suspension harness | | 117 |
| 9790004 | Accessories | Sweatband, leather | | 117 |
| 9790005 | Accessories | Leather chin straps | | 118 |
| 9790006 | Accessories | Paper cap | white | 116 |
| 9790007 | Accessories | Forked chin straps | | 118 |
| 9790010 | Accessories | Winter cap | black | 116 |
| 9790012 | Accessories | Winter cap | black | 116 |
| 9790015 | Accessories | Winter cap | black | 116 |
| 9790016 | Accessories | Winter cap | black | 116 |
| 9790018 | uvex pheos reflex set M | Reflective set | | 109 |
| 9790021 | Accessories | Four-point chin strap | | 111/118 |
| 9790022 | Accessories | Goggles clip/chin strap clip | | 118 |
| 9790023 | Accessories | Pen holder | | 118 |
| 9790029 | Accessories | LED head torch KS-6001-DUO | | 119 |
| 9790035 | Accessories | Leather chin straps | | 118 |
| 9790047 | Accessories | Helmet bracket | black | 129 |
| 9790048 | Accessories | Visor lens, PC | clear | 129 |
| 9790062 | Accessories | LED head torch pheos Lights | | 119 |
| 9790063 | Accessories | LED head torch pheos Lights EX | | 119 |
| 9790064 | Accessories | LED head torch u-cap sport | | 119 |
| 9790065 | Accessories | Winter cap | hi-viz yellow | 116 |
| 9790066 | Accessories | Balaclava | black | 116 |
| 9790067 | Accessories | Visor adapter | black | 128 |
| 9790068 | Accessories | Winter cap | hi-viz orange | 116 |
| 9790069 | Accessories | Helmet adapter for LED head torch u-cap sport | | 119 |
| 9790071 | Accessories | Helmet bag | | 118 |
| 9790074 | Accessories | Sunglare filter/rain cover | | 128 |
| 9790075 | Accessories | Neck protection | orange | 116 |
| 9790076 | Accessories | Neck protection | yellow | 116 |
| 9790077 | Accessories | Helmet slot sealing plug set | | 118 |
| 9790078 | Accessories | Helmet adapter | | 128 |
| 9790086 | Accessories | cooling neck protection | | 116 |
| 9790106 | Accessories | Business card holder | | 118 |
| 9790146 | Accessories | Signal whistle | | 111 |
| 9790210 | Accessories | Replacement visor (metal) | | 111 |
| 9790211 | uvex pheos faceguard | uvex pheos faceguard face protection system | | 131 |
| 9790212 | uvex pheos faceguard | uvex pheos faceguard face protection system with hearing protection | | 131 |
| 9790213 | Accessories | V3air rechargeable | | 120 |
| 9790214 | Accessories | Universal silicone strap | | 120 |
| 9794110 | Baseball cap | with long brim, size 55 – 63 cm | black | 137 |
| 9794111 | Baseball cap | with short brim, size 55 – 63 cm | black | 137 |
| 9794400 | uvex u-cap sport | Impact cap, size 52 – 54 cm | black | 137 |
| 9794401 | uvex u-cap sport | Impact cap, size 55 – 59 cm | black | 137 |
| 9794402 | uvex u-cap sport | Impact cap, size 60 – 63 cm | black | 137 |
| 9794403 | uvex u-cap sport | Impact cap, size 55 – 59 cm | black | 137 |
| 9794404 | uvex u-cap sport | Impact cap, size 60 – 63 cm | black | 137 |
| 9794407 | uvex u-cap sport | Impact cap, size 55 – 59 cm | navy blue | 138 |
| 9794408 | uvex u-cap sport | Impact cap, size 60 – 63 cm | navy blue | 138 |
| 9794409 | uvex u-cap sport | Impact cap, size 52 – 54 cm | black | 137 |
| 9794415 | uvex u-cap sport | Suspension harness | black | 137 |
| 9794416 | uvex u-cap sport vent | Impact cap, size 55 – 59 cm | black | 138 |
| 9794417 | uvex u-cap sport vent | Impact cap, size 60 – 63 cm | black | 138 |
| 9794420 | uvex u-cap sport vent | Impact cap, size 55 – 59 cm | black | 138 |
| 9794421 | uvex u-cap sport vent | Impact cap, size 60 – 63 cm | black | 138 |
| 9794422 | uvex u-cap sport | Impact cap, size 55 – 59 cm | black | 137 |
| 9794423 | uvex u-cap sport | Impact cap, size 55 – 59 cm | black | 137 |
| 9794424 | uvex u-cap sport | Impact cap, size 60 – 63 cm | black | 137 |
| 9794425 | uvex u-cap sport | Impact cap, size 60 – 63 cm | black | 137 |
| 9794430 | uvex u-cap sport vent | Impact cap, size 52 – 54 cm | black | 138 |
| 9794442 | uvex u-cap sport | Impact cap, size 52 – 54 cm | black | 137 |
| 9794443 | uvex u-cap sport | Impact cap, size 52 – 54 cm | black | 137 |
| 9794444 | uvex u-cap sport vent | Impact cap, size 52 – 54 cm | black | 138 |
| 9794480 | uvex u-cap sport hi-viz | Impact cap, size 55 – 59 cm | hi-viz yellow | 138 |
| 9794481 | uvex u-cap sport hi-viz | Impact cap, size 60 – 63 cm | hi-viz yellow | 138 |
| 9794482 | uvex u-cap sport hi-viz | Impact cap, size 52 – 54 cm | hi-viz yellow | 138 |
| 9794490 | uvex u-cap sport hi-viz | Impact cap, size 55 – 59 cm | hi-viz orange | 138 |
| 9794491 | uvex u-cap sport hi-viz | Impact cap, size 60 – 63 cm | hi-viz orange | 138 |
| 9794492 | uvex u-cap sport hi-viz | Impact cap, size 52 – 54 cm | hi-viz orange | 138 |
| 9906002 | Accessories | uvex pheos Visor | clear | 126 |
| 9906003 | Accessories | uvex pheos magnetic Visor | clear | 126 |
| 9906005 | Accessories | uvex pheos SLB 1 Visor | clear | 126 |
| 9906006 | Accessories | uvex pheos SLB 1 magnetic Visor | clear | 126 |
| 9906007 | Accessories | uvex pheos SLB 2 Visor | blue | 126 |
| 9906008 | Accessories | uvex pheos SLB 2 magnetic Visor | blue | 126 |
| 9906012 | Accessories | Replacement lens pheos Visor | clear | 126 |
| 9906013 | Accessories | Replacement lens pheos SLB 1 Visor | clear | 126/131 |
| 9906017 | Accessories | Replacement lens pheos SLB 2 Visor | blue | 126 |
| 9924010 | Accessories | Adapter | black | 129 |
| 9954362 | Accessories | Cloth bag for uvex visors | black | 128 |



uvex

Breathing Protection

EN149:2001+A1:2009

Respiratory protective devices – filtering half-masks for protection against particles

All uvex respirators are tested and approved in accordance with the **European standard 149**. This standard sets out a wide range of requirements for respirators, with the aim of providing the user with the highest level of protection and comfort.

The key tests defined in EN149 are:

- measuring inhalation and exhalation resistance
- testing the exhalation valve
- visual inspection (marking, instructions for use)
- determining the filtering efficiency (protection class)
- optional: carrying out the dolomite dust test

Detailed information about the standards and guidelines for respiratory protection is available at:

<https://ures.uvex.de>

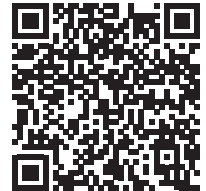

The standard divides respirators into three protection classes according to their filtering efficiency and leakage:

FFP 1

FFP1 respirators have a filtering capacity of at least 80% and filter up to four times the respective occupational exposure limit (OEL*). These masks are suitable for particles that are neither toxic nor fibrogenic.

FFP 2

FFP2 respirators are suitable for smoke, particles and dusts that are noxious or harmful to health. They filter at least 94% of particles and can be used up to ten times the respective occupational exposure limit (OEL*).

FFP 3

With a filtering efficiency of at least 99%, FFP3 masks constitute the highest protection class. They filter up to 30 times the respective occupational exposure limit (OEL*) and are suitable for protecting against toxic particles, dusts and smoke.



So that you can see the protection class at a glance, the marking is **blue** on FFP1 masks, **orange** on FFP2 masks and **black** on FFP3 masks.



In addition to the standard tests, all uvex masks fulfil the additional requirement of the dolomite dust test and are therefore marked with the letter D.

Therefore the uvex respiratory protection products ensure an excellent breathability, even in extremely dusty environments and during prolonged use.

All uvex respirators are in line with current EU legislation. All respiratory protective devices fall into PPE category III (high risks).

* OELs = The occupational exposure limit values (OELs) are the average concentration of a substance in the air in the workplace, up to which no damage (chronic or acute) is to be expected if employees work there for eight hours a day for five days a week. The OELs replace the maximum workplace concentration (MWC) and the technical reference concentration (TRC) – however, as long as both of these values are not yet fully taken into account in the OELs, they can still be used on an interim basis for assessing risks in the workplace.

uvex silv-Air

Respirator advisor · Cleaning

uvex Respiratory Expert System —
your online respiratory protection
consultant

As a leader of innovation, we place the highest demands on our products and services. The uvex Respiratory Expert System (ures) can help you choose a suitable respirator and provide you with a wealth of information about products, standards, functions and technologies.

You can select the right mask from the uvex range according to the work you will be carrying out or the hazardous substance you will be handling. All products are accompanied by detailed images and photos of the product in use, as well as an overview of all the product's features. There are various different documents (e.g. product data sheets) and videos at your disposal too.

This enables the online respiratory protection consultant to give you a quick yet comprehensive overview of our products and answer your key questions about respiratory protection all in one place.

Discover a new dimension of respiratory protection:

<https://ures.uvex.de>



8701011

uvex clear

• cleaning spray for cleaning respirators marked with "R"

| | |
|---------------------------|---------|
| uvex clear cleaning spray | |
| Art. no. | 8701011 |
| Order quantity multiples | 1 PC |
| Content | 360 ml |

The uvex breathing protection navigator

The fast route to finding the right respirator for your needs

Choosing the right respiratory protective devices is essential for ensuring the safety of the respective wearer and is a process that requires the utmost care.

In order to choose the filtering respirator that meets your requirements, please observe the following points:



- the type, composition and concentration of the hazardous substances must be provided/known (note the CAS number and OEL). The measurement can be carried out by the employers' liability insurance association, for example. The minimum requirements for selected areas of application can be found on the next page.
- after determining the protection class required (FFP1, FFP2 or FFP3), the following table can be used to select a respirator model that meets the requirements of the respective work conditions.
- there must be a sufficient volume of oxygen in the environment. Please observe the statutory regulations in this regard. A minimum of 17 vol% is required in Germany.
- if further PPE is required, this must be compatible. uvex respirators are ideal for use in combination with uvex safety spectacles – see the compatibility table on page 147.
- respiratory protective devices are not suitable for people with beards, sideburns or deep scars near the respirator sealing lines as these prevent a secure fit. Please contact your safety officer for a custom solution.
- Masks marked "NR" should not be used for more than eight hours. Masks marked "R" may be used for up to 24 hours but must be cleaned after each period of use. Masks should be replaced without delay if the breathing resistance becomes noticeably higher.
- if a half-mask with gas filters is required for the work-space, please note that the uvex respirator models do not offer adequate protection.

Selection

| Brief periods of use or lighter activities at normal ambient temperatures | | |
|--|--|---|
| Protection class | Folding mask (with or without valve) | Cup-style mask (without or without valve) |
| FFP1 | 3100, 3110, 8103, 8113, 5100, 5100+, 5110, 5110+ | 2100, 2110, 7100, 7110 |
| FFP2 | 3200, 3210, 8203, 8213, 5200, 5200+, 5210, 5210+ | 2200, 2210, 7200, 7210, 7212 |
| FFP3 | 3310, 8313, 5310, 5310+ | 2310, 2312, 7310 |
| Long periods of wear or hard, strenuous activities at increased ambient temperatures | | |
| Protection class | Folding mask (with valve) | Cup-style mask (with valve) |
| FFP1 | 3110, 8113, 5110, 5110+ | 2110, 7110 |
| FFP2 | 3210, 8213, 5210, 5210+ | 2210, 7210, 7212, 7233, 7232 |
| FFP3 | 3310, 8313, 5310, 5310+ | 2310, 2312, 7310, 7333, 7330, 7312, 7317 |
| With activated carbon layer to protect against unpleasant odours | | |
| Protection class | Folding mask (with valve) | Cup-style mask (with valve) |
| FFP1 | – | – |
| FFP2 | 3220, 5220+ | 2220, 7220 |
| FFP3 | 5320+ | 7320 |

► The minimum requirements for selected areas of application can be found on page 145.

uvex silv-Air

Areas of application



| Activity | Harmful substances | Protection class | | |
|---|-------------------------------------|------------------|------|------|
| | | FFP1 | FFP2 | FFP3 |
| Wood processing | | | | |
| Softwood: cutting and sanding | Fine particles, wood dust | | ■ | |
| Hard wood (oak, beech, tropical woods, etc.): cutting and sanding | Fine particles, wood dust | | | ■ |
| Brushing/sanding paint | Fine colour particles | | ■ | |
| Brushing/sanding paint (paints containing chrome) | Fine colour particles | | | ■ |
| Soluble paints containing copper/chrome/arsenic | Fine paint mist | | | ■ |
| Construction and ancillary building industry | | | | |
| Cement work, plastering, tiling, roofing | Cement, plaster, tile or brick dust | | ■ | |
| Masonry: cutting, drilling, demolition | | | ■ | |
| Asbestos: short periods of work | Fibres | | | ■ |
| Roof insulation: glass and mineral fibres | Dust and fibres | | ■ | |
| Bodyfillers/stopper: Grinding | Dust | | ■ | |
| Welding | | | | |
| Welding aluminium and stainless steel | Metal and aluminium oxide fumes | | | ■ |
| Brazing | Fumes | | | ■ |
| Metalwork | | | | |
| Metal: drilling, grinding, milling, angle grinding | Metal dust | | ■ | |
| High-alloy steels and stainless steels: drilling, grinding, milling, angle grinding | Metal dust | | | ■ |
| Waste disposal and cleaning | | | | |
| Refuse separation and disposal | Dust, fungi | | ■ | |
| Medical waste disposal | Bacteria, spores | | | ■ |
| Sweeping floors | Dust (non-toxic) | ■ | | |
| Radioactively contaminated particles | Dust | | | ■ |
| Agriculture | | | | |
| Animal epidemics and treatment of animals with diseases | Bacteria, viruses | | | ■ |
| Work with fungal spores | Spores | | | ■ |
| Work with hay, grain and flour | Dust | ■ | | |
| Medicine/care/health | | | | |
| Allergies, pollen, household dust, animal fur | Dust, particles, spores | | ■ | |
| Bacteria, viruses, infections, legionella bacteria | Bacteria, viruses | | | ■ |



► These filter classes are minimum requirements and simply serve as a guide. It is the wearers' responsibility to make sure the breathing apparatus conforms to the requirements in terms of hazardous materials and concentration before use!

Perfect Match

Protection from a single source



For many years, has been a global leader in industrial safety eyewear. uvex has built on this expertise in the development of its highly functional uvex silv-Air respirators.

With the aim of creating two products that can be worn together perfectly, eyewear and breathing protection product development was carried out in close consultation. Safety eyewear and breathing protection were regarded as one, uniting to provide the best possible protection.

The result of this combined expertise is the three dimensional shape of uvex silv-Air respirators. They ensure an optimum, close fit of safety eyewear, without slipping and wobbling. As the equipment remains firmly in place, optimum eye protection is guaranteed. uvex preformed and folding masks are therefore particularly suitable for combination with uvex safety eyewear.

Trust protection from a single source.



Three dimensional optimised nose shape for optimum combination of respirator with safety eyewear.

Perfect Match

Combination options of uvex silv-Air respirators with uvex safety eyewear

These recommendations are based on experience. We recommend always carrying out wearability tests.

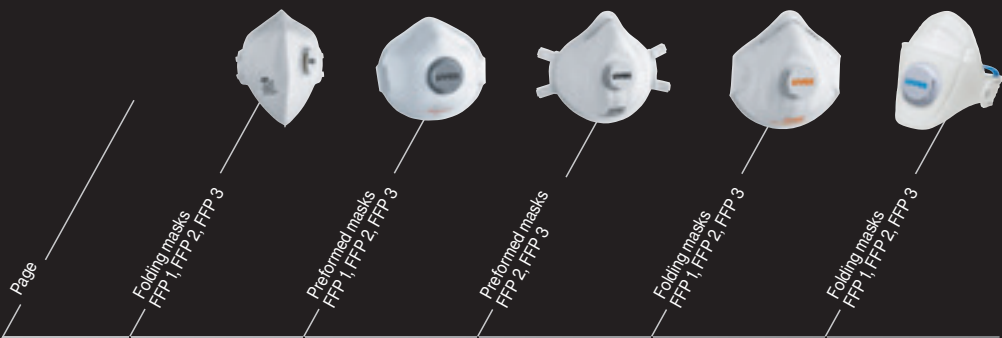

| | Page | Folding masks FFP 1, FFP 2, FFP 3 | Performed masks FFP 1, FFP 2, FFP 3 | Performed masks FFP 2, FFP 3 | Folding masks FFP 1, FFP 2, FFP 3 | Folding masks FFP 1, FFP 2, FFP 3 |
|--|-------------|--------------------------------------|--|---------------------------------|--------------------------------------|---|
| uvex silv-Air e | 154 - 156 | | 7212, 7233, 7312, 7317, 7333 | 7232, 7330 | | |
| uvex silv-Air p | 157 - 160 | 8103, 8113, 8203, 8213, 8313 | 7100, 7110, 7200, 7210, 7220 | 7310, 7320 | | |
| uvex silv-Air c | 161 - 165 | 3100, 3110, 3200, 3210, 3220, 3310 | | 2310, 2312 | 2100, 2110, 2200, 2210, 2220 | |
| uvex silv-Air premium | 149 - 152 | | | | | 5100, 5100+, 5110, 5110+, 5200, 5200+, 5210, 5210+, 5220+, 5310, 5310+, 5320+ |
| uvex i-3 uvex i-5 | 34/35 23 | ■ | □ | □ | □ | ■ |
| uvex pheos uvex sportstyle | 31/32 29 | ■ | ■ | □ | ■ | ■ |
| uvex super fit uvex super g | 39 38 | ■ | ■ | □ | □ | ■ |
| uvex x-fit uvex x-fit pro | 27 25 | ■ | ■ | ■ | ■ | ■ |
| uvex i-vo | 40 | ■ | ■ | □ | ■ | ■ |
| uvex i-works | 36 | ■ | □ | □ | □ | ■ |
| uvex pheos cx2 | 30 | ■ | □ | □ | □ | ■ |
| uvex pheos cx2 sonic | 50 | ■ | ■ | ■ | ■ | ■ |
| uvex super OTG uvex super f OTG | 46 47 | ■ | ■ | ■ | ■ | ■ |
| uvex astrospec 2.0 uvex skyguard NT | 37 43 | ■ | □ | □ | ■ | ■ |
| uvex carbonvision uvex u-sonic | 57 51 | ■ | ■ | □ | □ | ■ |
| uvex ultrasonic uvex ultravision | 53 54/55 | ■ | ■ | ■ | ■ | ■ |
| uvex megasonic | 49 | ■ | □ | □ | ■ | ■ |

■ Perfect combination □ Suitable to a limited extent



uvex silv-Air premium
Respirators

| uvex silv-Air premium | | | | | |
|---|---|---|--|---|---|
| FFP 1 | | FFP 2 | | FFP 3 | |
| flat fold | | flat fold | | flat fold | |
| Small version | Large version | Small version | Large version | Small version | Large version |
|  |  |  |  | | |
| 5100 NR D | 5100+ NR D | 5200 NR D | 5200+ NR D | | |
|  |  |  |  |  |  |
| 5110 NR D | 5110+ NR D | 5210 NR D | 5210+ NR D | 5310 NR D | 5310+ NR D |
| | | |  | |  |
| | | | 5220+ NR D with carbon | | 5320+ NR D with carbon |

uvex silv-Air premium

Respirators, class FFP1, FFP2 and FFP3



- contour-optimised design for maximum wearer comfort and a secure fit
- available in two sizes for improved fit
- sealing lip (in the nose area for FFP1 and FFP2, in the nose and chin area for FFP3) and nose clip provide greater comfort and a very secure fit
- the masks are packaged individually to meet the highest hygiene requirements
- adjustable textile headband for greater protection and comfort
- optional: exhalation valve for reducing heat and humidity
- models in FFP2 and FFP3 against unpleasant odours available (5220+, 5320+)

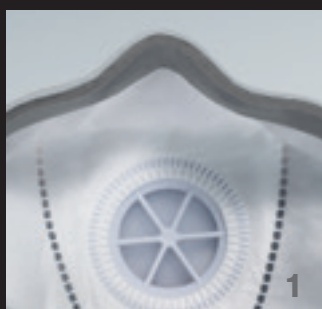

The nose clip is easy to adjust, ensuring a particularly good fit.



The comfortable sealing lip offers maximum comfort and a reliable fit.



The masks are packaged individually and therefore meet the highest hygiene requirements.

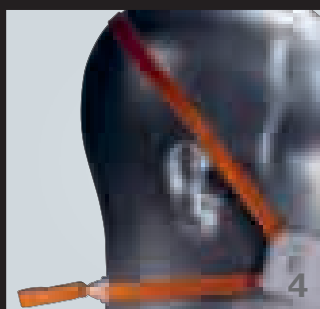

The extra-wide textile headband ensures that the mask fits comfortably and securely.



Exhalation valve for reducing heat and humidity.

uvex silv-Air premium

Respirators in protection class FFP1



8765100
8775100



8765110
8775110

uvex silv-Air 5100

- particle-filtering flat-fold mask for **small to medium face shapes**
- wide, seamless headband for ensuring a comfortable and secure fit
- incorporated nose clip that is easy to adjust
- comfortable sealing lip in the nose area for a reliable fit

uvex silv-Air 5110

- particle-filtering flat-fold mask for **small to medium face shapes**
- wide, seamless headband for ensuring a comfortable and secure fit
- incorporated nose clip that is easy to adjust
- comfortable sealing lip in the nose area for a reliable fit
- exhalation valve for reducing heat and humidity as well as noticeably reducing breathing resistance

| | | | | |
|--------------------------|--|---------|---|---------|
| | uvex silv-Air 5100 | | uvex silv-Air 5110 | |
| Art. no. | 8765100 | 8775100 | 8765110 | 8775110 |
| Version | FFP1 NR D folding mask without valve – small version | | FFP1 NR D folding mask with valve – small version | |
| Colour | white | | white | |
| Order quantity multiple/ | 30 PC | BG | 15 PC | BG |
| Order unit | 30 PC, individually packed in BOX | | 15 PC, individually packed in BOX | |
| Content | 3 PC, individually packed in BG | | 3 PC, individually packed in BG | |



8765101
8775101



8765111
8775111

uvex silv-Air 5100+

- particle-filtering flat-fold mask for **larger face shapes**
- wide, seamless headband for ensuring a comfortable and secure fit
- comfortable sealing lip in the nose area for a reliable fit
- incorporated nose clip that is easy to adjust
- exhalation valve for reducing heat and humidity as well as noticeably reducing breathing resistance

uvex silv-Air 5110+

- particle-filtering flat-fold mask for **larger face shapes**
- wide, seamless headband for ensuring a comfortable and secure fit
- comfortable sealing lip in the nose area for a reliable fit
- incorporated nose clip that is easy to adjust
- exhalation valve for reducing heat and humidity as well as noticeably reducing breathing resistance

| | | | | |
|--------------------------|--|---------|---|---------|
| | uvex silv-Air 5100+ | | uvex silv-Air 5110+ | |
| Art. no. | 8765101 | 8775101 | 8765111 | 8775111 |
| Version | FFP1 NR D folding mask without valve – large version | | FFP1 NR D folding mask with valve – large version | |
| Colour | white | | white | |
| Order quantity multiple/ | 30 PC | BG | 15 PC | BG |
| Order unit | 30 PC, individually packed in BOX | | 15 PC, individually packed in BOX | |
| Content | 3 PC, individually packed in BG | | 3 PC, individually packed in BG | |

uvex silv-Air premium Respirators in protection class FFP2



8765200
8775200



8765210
8775210

uvex silv-Air 5200

- particle-filtering flat-fold mask for **small to medium face shapes**
- wide, seamless headband for ensuring a comfortable and secure fit
- incorporated nose clip that is easy to adjust
- comfortable sealing lip in the nose area for a reliable fit

uvex silv-Air 5210

- particle-filtering flat-fold mask for **small to medium face shapes**
- wide, seamless headband for ensuring a comfortable and secure fit
- comfortable sealing lip in the nose area for a reliable fit
- incorporated nose clip that is easy to adjust
- exhalation valve for reducing heat and humidity as well as noticeably reducing breathing resistance



| | uvex silv-Air 5200 | | uvex silv-Air 5210 | |
|--------------------------|--|---------------------------------|---|---------------------------------|
| Art. no. | 8765200 | 8775200 | 8765210 | 8775210 |
| Version | FFP2 NR D folding mask without valve – small version | | FFP2 NR D folding mask with valve – small version | |
| Colour | white | | white | |
| Order quantity multiple/ | 30 PC | BG | 15 PC | BG |
| Order unit | | | | |
| Content | 30 PC, individually packed in BOX | 3 PC, individually packed in BG | 15 PC, individually packed in BOX | 3 PC, individually packed in BG |



8765201
8775201



8765211
8775211



8765221
8775221

uvex silv-Air 5200+

- particle-filtering flat-fold mask for **larger face shapes**
- wide, seamless headband for ensuring a comfortable and secure fit
- incorporated nose clip that is easy to adjust
- comfortable sealing lip in the nose area for a reliable fit

uvex silv-Air 5210+

- particle-filtering flat-fold mask for **larger face shapes**
- wide, seamless headband for ensuring a comfortable and secure fit
- comfortable sealing lip in the nose area for a reliable fit
- incorporated nose clip that is easy to adjust
- exhalation valve for reducing heat and humidity as well as noticeably reducing breathing resistance

uvex silv-Air 5220+

- particle-filtering flat-fold mask for **larger face shapes**
- wide, seamless headband for ensuring a comfortable and secure fit
- additional activated carbon filter for protection against odours, gases and vapours under the respective limit values
- comfortable sealing lip in the nose area for a reliable fit
- incorporated nose clip that is easy to adjust
- exhalation valve for reducing heat and humidity as well as noticeably reducing breathing resistance

| | uvex silv-Air 5200+ | | uvex silv-Air 5210+ | | uvex silv-Air 5220+ | |
|--------------------------|--|---------------------------------|---|---------------------------------|--|---------------------------------|
| Art. no. | 8765201 | 8775201 | 8765211 | 8775211 | 8765221 | 8775221 |
| Version | FFP2 NR D folding mask without valve – large version | | FFP2 NR D folding mask with valve – large version | | FFP2 NR D folding mask with valve and carbon – large version | |
| Colour | white | | white | | grey | |
| Order quantity multiple/ | 30 PC | BG | 15 PC | BG | 15 PC | BG |
| Order unit | | | | | | |
| Content | 30 PC, individually packed in BOX | 3 PC, individually packed in BG | 15 PC, individually packed in BOX | 3 PC, individually packed in BG | 15 PC, individually packed in BOX | 3 PC, individually packed in BG |

uvex silv-Air premium Respirators in protection class FFP3



8765310
8775310

uvex silv-Air 5310

- particle-filtering flat-fold mask for **small to medium face shapes**
- wide, seamless headband for ensuring a comfortable and secure fit
- comfortable sealing lip in the nose and chin area for a reliable fit
- incorporated nose clip that is easy to adjust
- exhalation valve for reducing heat and humidity as well as noticeably reducing breathing resistance

| | | |
|--------------------------|---|---------------------------------|
| | uvex silv-Air 5310 | |
| Art. no. | 8765310 | 8775310 |
| Version | FFP3 NR D folding mask with valve – small version | |
| Colour | white | |
| Order quantity multiple/ | 15 PC | BG |
| Order unit | | |
| Content | 15 PC, individually packed in BOX | 3 PC, individually packed in BG |



8765311
8775311



8765321
8775321

uvex silv-Air 5310+

- particle-filtering flat-fold mask for **larger face shapes**
- wide, seamless headband for ensuring a comfortable and secure fit
- comfortable sealing lip in the nose and chin area for a reliable fit
- incorporated nose clip that is easy to adjust
- exhalation valve for reducing heat and humidity as well as noticeably reducing breathing resistance

| | | | | |
|--------------------------|---|---------------------------------|--|---------------------------------|
| | uvex silv-Air 5310+ | | uvex silv-Air 5320+ | |
| Art. no. | 8765311 | | 8765321 | |
| Version | FFP3 NR D folding mask with valve – large version | | FFP3 NR D folding mask with valve and carbon – large version | |
| Colour | white | | grey | |
| Order quantity multiple/ | 15 PC | BG | 15 PC | BG |
| Order unit | | | | |
| Content | 15 PC, individually packed in BOX | 3 PC, individually packed in BG | 15 PC, individually packed in BOX | 3 PC, individually packed in BG |













uvex silv-Air 5320+

- particle-filtering flat-fold mask for **larger face shapes**
- wide, seamless headband for ensuring a comfortable and secure fit
- additional activated carbon filter for protection against odours, gases and vapours under the respective limit values
- comfortable sealing lip in the nose and chin area for a reliable fit
- incorporated nose clip that is easy to adjust
- exhalation valve for reducing heat and humidity as well as noticeably reducing breathing resistance

uvex silv-Air e+p
Respirators

| uvex silv-Air e | | | | | |
|-----------------|--|---|--|---|---|
| FFP 1 | | FFP 2 | | FFP 3 | |
| | | cup style | | cup style | |
| | |  | |  |  |
| | | 7212 NR D | | 7312 R D | 7317 R D |
| | |  |  |  |  |
| | | 7232 R D | 7233 R D | 7333 R D | 7330 R D |



| uvex silv-Air p | | | | | |
|---|---|---|---|---|---|
| FFP 1 | | FFP 2 | | FFP 3 | |
| flat fold | cup style | flat fold | cup style | flat fold | cup style |
|  |  |  |  | | |
| 8103 NR D | 7100 NR D | 8203 NR D | 7200 NR D | | |
|  |  |  |  |  |  |
| 8113 NR D | 7110 NR D | 8213 NR D | 7210 NR D | 8313 NR D | 7310 R D |
| | | |  | |  |
| | | | with carbon 7220 NR D | | with carbon 7320 R D |

uvex silv-Air e

High-performance respirators in FFP2 and FFP3

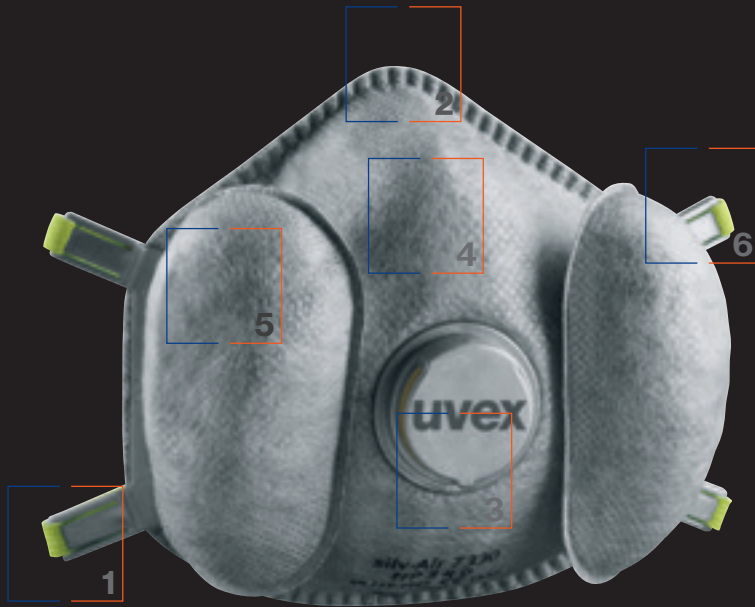

- high-performance respirator – excellent protection with maximum wearer comfort
- the combination of a high-quality filter material and a larger filter surface noticeably reduces the breathing resistance
- the additional inhalation valves ensure a cool climate inside the mask (cooling effect)
- 3D nose geometry for a perfectly secure fit
- adjustable textile headband for a customised and comfortable fit
- the integrated sealing lip provides extremely high comfort



Adjustable headband for optimum fit

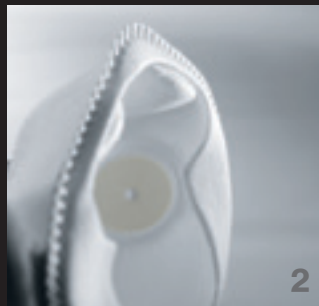

Perfectly shaped around the nose for secure positioning



Large inhalation valves ensure extremely low breathing resistance.



Nasal recess ensures a perfect fit for almost any nose shape.



High-quality uvex silv-Air outer material for best possible breathability.



Flexible 4-point headband attachment for a comfortable fit.

uvex silv-Air e

High-performance respirators in FFP2 and FFP3



8707233
8707333



8707232
8707330



**uvex silv-Air High-Performance –
A new dimension in breathing protection**

- particle-filtering preformed mask with exhalation valve and inhalation valves
- High-performance climazone system with three compartments for a comfortable, cool climate inside the mask
- flexible textile headband with neck clip for individual adjustment
- exhalation valve to further reduce breathing resistance, by helping to minimise moisture build up inside the mask
- two extra filters with inhalation valves for lower breathing resistance and increased comfort due to easier air exchange
- very soft, all-around sealing lip for optimal wearer comfort and secure fit
- combination of 3D nose area and sealing lip ensures ideal fit for almost any nose shape

| | | |
|---------------------------------|-------------------------|-------------------------|
| | uvex silv-Air 7233 | uvex silv-Air 7333 |
| Art. no. | 8707233 | 8707333 |
| Version | FFP2 R D preformed mask | FFP3 R D preformed mask |
| | with valves | with valves |
| Colour | white | white |
| Order quantity multiples | 3 PC | 3 PC |
| Content | 3 PC, packed in BOX | 3 PC, packed in BOX |

**uvex silv-Air High-Performance –
Perfect protection combined with
maximum wearer comfort**

- particle-filtering preformed mask with exhalation valve and inhalation valves
- High-performance climazone system with three compartments for a comfortable, cool climate inside the mask
- four-point headband attachment for a comfortable, individual and secure fit
- flexible, adjustable integrated nose clip
- exhalation valve to further reduce breathing resistance, by helping to minimise moisture build up inside the mask
- two extra filters with inhalation valves for lower breathing resistance and increased comfort due to easier air exchange
- very soft, all-around sealing lip for optimal wearer comfort and secure fit
- nasal recess on the sealing lip ensures ideal fit for almost any nose shape

| | | |
|---------------------------------|-------------------------|-------------------------|
| | uvex silv-Air 7232 | uvex silv-Air 7330 |
| Art. no. | 8707232 | 8707330 |
| Version | FFP2 R D preformed mask | FFP3 R D preformed mask |
| | with valves | with valves |
| Colour | silver grey | silver grey |
| Order quantity multiples | 3 PC | 3 PC |
| Content | 3 PC, packed in BOX | 3 PC, packed in BOX |

uvex silv-Air e

Respirators in protection class FFP2 and FFP3



8707317
8707318



8707312



8707212

uvex silv-Air 7317

- particle-filtering preformed mask with exhalation valve
- soft material edges for increased comfort
- very soft, all-around sealing lip for optimal wearer comfort and secure fit
- without nose clip (metal-free)
- four-point headband attachment for a comfortable, individual and secure fit
- exhalation valve to further reduce breathing resistance, by helping to minimise moisture build up inside the mask
- extra-wide textile headband ensures that the mask fits comfortably and securely

uvex silv-Air 7312

- particle-filtering preformed mask with exhalation valve
- soft material edges for increased comfort
- very soft, all-around sealing lip for optimal wearer comfort and secure fit
- flexible, adjustable integrated nose clip
- four-point headband attachment for a comfortable, individual and secure fit
- exhalation valve to further reduce breathing resistance, by helping to minimise moisture build up inside the mask

uvex silv-Air 7212

- particle-filtering preformed mask with exhalation valve
- soft material edges for increased comfort
- seamless headband for a comfortable, secure fit
- very soft, all-around sealing lip for optimal wearer comfort and secure fit
- flexible, adjustable integrated nose clip
- exhalation valve to further reduce breathing resistance, by helping to minimise moisture build up inside the mask

| uvex silv-Air 7317 | | |
|--------------------|------------------------------------|----------------------|
| Art. no. | 8707317 | 8707318 |
| Version | FFP3 R D preformed mask with valve | |
| Colour | white | |
| Order unit | BOX | CT |
| Content | 5 PC, | 120 PC, individually |
| | packed in BOX | packed in CT |

| uvex silv-Air 7312 | |
|---------------------------------|------------------------------------|
| Art. no. | 8707312 |
| Version | FFP3 R D preformed mask with valve |
| Colour | white |
| Order quantity multiples | 5 PC |
| Content | 5 PC, packed in BOX |

| uvex silv-Air 7212 | |
|---------------------------------|-------------------------------------|
| Art. no. | 8707212 |
| Version | FFP2 NR D preformed mask with valve |
| Colour | white |
| Order quantity multiples | 15 PC |
| Content | 15 PC, packed in BOX |



Anatomically preformed nose area and integrated nosepiece within the filter material, ensures a perfect fit and the highest level of wearer comfort.



4-point headband attachment for a comfortable, secure fit of the mask.



The high-quality filter material ensures low breathing resistance, while the smooth white filter surface reduces the risk of contamination through "linting" in areas with strict hygiene standards.

uvex silv-Air p

Respirators in protection class FFP1, FFP2 and FFP3

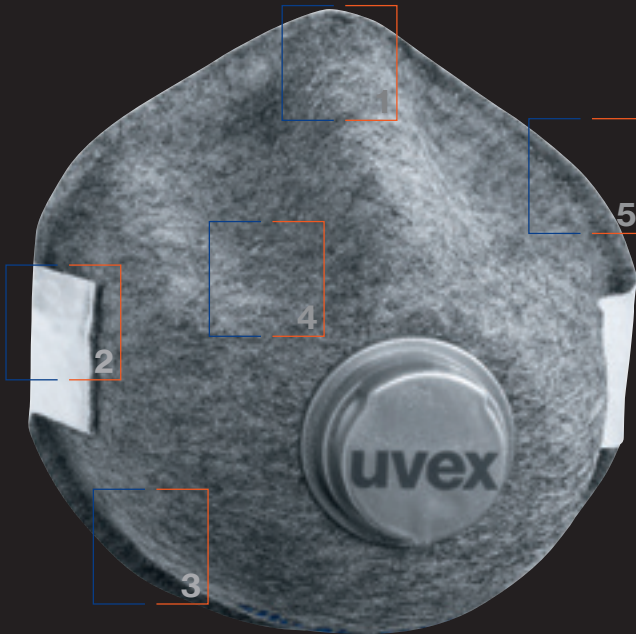

- soft material edges for increased comfort
- Optional: exhalation valve for reducing heat and humidity
- optimised nose area design ensures maximum compatibility with uvex safety eyewear
- silver-grey uvex silv-Air outer material is pleasant to touch and prevents mask being discarded prematurely on account of surface staining
- the FFP3 models also have a nose clip and four-point headband attachment for maximum comfort



1 All FFP1 and FFP2 preformed masks are completely metal-free.



2 Seamless, flexible headband for even pressure distribution and a comfortable fit.



3 All-round soft material edges for increased comfort.



4 Three-dimensional, optimised shape can be combined with safety eye protection and a secure fit is guaranteed without a nose clip

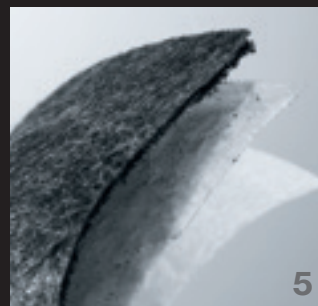

5 FFP2 preformed mask also available with activated carbon filter against unpleasant odours.

uvex silv-Air p

Respirators in protection class FFP1



8707100



8707110

uvex silv-Air 7100

- particle-filtering preformed mask
- metal-free processing
- soft material edges for increased comfort
- seamless headband for a comfortable, secure fit

| | |
|---------------------------------|--|
| uvex silv-Air 7100 | |
| Art. no. | 8707100 |
| Version | FFP1 NR D preformed mask without valve |
| Colour | silver grey |
| Order quantity multiples | 20 PC |
| Content | 20 PC, packed in BOX |

uvex silv-Air 7110

- particle-filtering preformed mask with exhalation valve
- metal-free processing
- soft material edges for increased comfort
- seamless headband for a comfortable, secure fit
- exhalation valve to further reduce breathing resistance, by helping to minimise moisture build up inside the mask

| | |
|---------------------------------|-------------------------------------|
| uvex silv-Air 7110 | |
| Art. no. | 8707110 |
| Version | FFP1 NR D preformed mask with valve |
| Colour | silver grey |
| Order quantity multiples | 15 PC |
| Content | 15 PC, packed in BOX |



8708103



8708113

uvex silv-Air 8103

- particle-filtering folding mask
- hydrophobic material coating
- seamless headband for a comfortable, secure fit
- flexible, adjustable integrated nose clip
- foam layers in chin and nose area for optimal fit

| | |
|---------------------------------|--------------------------------------|
| uvex silv-Air 8103 | |
| Art. no. | 8708103 |
| Version | FFP1 NR D folding mask without valve |
| Colour | silver |
| Order quantity multiples | 20 PC |
| Content | 20 PC, individually packed in BOX |

uvex silv-Air 8113

- particle-filtering folding mask with exhalation valve
- hydrophobic material coating
- seamless headband for a comfortable, secure fit
- Flexible, adjustable integrated nose piece
- foam layers in chin and nose area for optimal fit
- exhalation valve to further reduce breathing resistance, by helping to minimise moisture build up inside the mask

| | |
|---------------------------------|-----------------------------------|
| uvex silv-Air 8113 | |
| Art. no. | 8708113 |
| Version | FFP1 NR D folding mask with valve |
| Colour | silver |
| Order quantity multiples | 15 PC |
| Content | 15 PC, individually packed in BOX |

uvex silv-Air p
Respirators in protection class FFP2



8707200



8707210



8707220

uvex silv-Air 7200

- particle-filtering preformed mask
- metal-free processing
- seamless headband for a comfortable, secure fit

| | |
|---------------------------------|--|
| uvex silv-Air 7200 | |
| Art. no. | 8707200 |
| Version | FFP2 NR D preformed mask without valve |
| Colour | silver grey |
| Order quantity multiples | 20 PC |
| Content | 20 PC, packed in BOX |

uvex silv-Air 7210

- particle-filtering preformed mask with exhalation valve
- metal-free processing
- seamless headband for a comfortable, secure fit
- exhalation valve to further reduce breathing resistance, by helping to minimise moisture build up inside the mask

| | |
|---------------------------------|-------------------------------------|
| uvex silv-Air 7210 | |
| Art. no. | 8707210 |
| Version | FFP2 NR D preformed mask with valve |
| Colour | silver grey |
| Order quantity multiples | 15 PC |
| Content | 15 PC, packed in BOX |

uvex silv-Air 7220

- particle-filtering preformed mask with exhalation valve
- metal-free processing
- additional activated carbon filter against odours, gases and vapours below threshold
- seamless headband for a comfortable, secure fit
- exhalation valve to further reduce breathing resistance, by helping to minimise moisture build up inside the mask

| | |
|---------------------------------|--|
| uvex silv-Air 7220 | |
| Art. no. | 8707220 |
| Version | FFP2 NR D preformed mask with valve and carbon |
| Colour | silver, anthracite |
| Order quantity multiples | 15 PC |
| Content | 15 PC, packed in BOX |



8708203



8708213

uvex silv-Air 8203

- particle-filtering folding mask
- hydrophobic material coating
- seamless headband for a comfortable, secure fit
- flexible, adjustable integrated nose clip
- foam layers in chin and nose area for optimal fit

| | |
|---------------------------------|--------------------------------------|
| uvex silv-Air 8203 | |
| Art. no. | 8708203 |
| Version | FFP2 NR D folding mask without valve |
| Colour | silver |
| Order quantity multiples | 20 PC |
| Content | 20 PC, individually packed in BOX |

uvex silv-Air 8213

- particle-filtering folding mask with climate-optimised exhalation valve
- hydrophobic material coating
- seamless headband for a comfortable, secure fit
- flexible, adjustable integrated nose clip
- foam layers in chin and nose area for optimal fit

| | |
|---------------------------------|-----------------------------------|
| uvex silv-Air 8213 | |
| Art. no. | 8708213 |
| Version | FFP2 NR D folding mask with valve |
| Colour | silver |
| Order quantity multiples | 15 PC |
| Content | 15 PC, individually packed in BOX |

uvex silv-Air p

Respirators in protection class FFP3



8707310



8707320

uvex silv-Air 7310

- particle-filtering preformed mask with exhalation valve
- very soft, all-around sealing lip for optimal wearer comfort and secure fit
- flexible, adjustable integrated nose clip
- four-point headband attachment for a comfortable, individual and secure fit
- exhalation valve to further reduce breathing resistance, by helping to minimise moisture build up inside the mask

| | |
|---------------------------------|------------------------------------|
| uvex silv-Air 7310 | |
| Art. no. | 8707310 |
| Version | FFP3 R D preformed mask with valve |
| Colour | silver grey |
| Order quantity multiples | 5 PC |
| Content | 5 PC, packed in BOX |

uvex silv-Air 7320

- particle-filtering preformed mask with exhalation valve
- additional activated carbon filter against odours, gases and vapours below threshold
- very soft, all-around sealing lip for optimal wearer comfort and secure fit
- flexible, adjustable integrated nose clip
- four-point headband attachment for a comfortable, individual and secure fit
- exhalation valve to further reduce breathing resistance, by helping to minimise moisture build up inside the mask

| | |
|---------------------------------|---|
| uvex silv-Air 7320 | |
| Art. no. | 8707320 |
| Version | FFP3 R D preformed mask with valve and carbon |
| Colour | silver, anthracite |
| Order quantity multiples | 5 PC |
| Content | 5 PC, packed in BOX |



8708313

uvex silv-Air 8313













- particle-filtering folding mask with exhalation valve
- hydrophobic material coating
- four-point headband attachment for a comfortable, individual and secure fit
- flexible, adjustable integrated nose clip
- very soft, all-around sealing lip for optimal wearer comfort and secure fit
- exhalation valve to further reduce breathing resistance, by helping to minimise moisture build up inside the mask

| | |
|---------------------------------|-----------------------------------|
| uvex silv-Air 8313 | |
| Art. no. | 8708313 |
| Version | FFP3 NR D folding mask with valve |
| Colour | silver |
| Order quantity multiples | 15 PC |
| Content | 15 PC, individually packed in BOX |

uvex silv-Air c
Respirators



uvex silv-Air c

| | FFP 1 | | FFP 2 | | | FFP 3 | |
|-----------|--|--|--|--|--|--|--|
| flatfold |  3100 NR D |  3110 NR D |  3200 NR D |  3210 NR D |  3220 NR D with carbon |  3310 NR D | |
| cup style |  2100 NR D |  2110 NR D |  2200 NR D |  2210 NR D |  2220 NR D with carbon |  2310 NR D |  2312 NR D |

uvex silv-Air c

Respirators in protection class FFP1, FFP2 and FFP3



- soft material edges for greater comfort and wearer acceptance
- continuous textile headband ensures that the mask fits comfortably and securely
- optional: exhalation valve to reduce heat and humidity in the mask
- sealing lip (in the nose area for FFP1 and FFP2, all-round for FFP3) and nose clip provide maximum protection and comfort
- FFP2 models against unpleasant odours available (2220, 3220)
- FFP3 preformed masks are available in two sizes and also have a four-point headband attachment



1
The adjustable nose clip ensures an excellent individual fit and secure positioning.

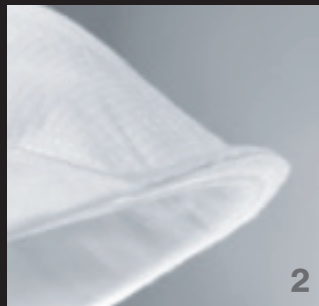

2
The soft material edges prevent uncomfortable pressure points.

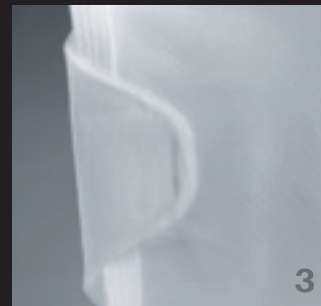

3
The seamless headband can be adjusted for an optimum fit.



4
The exhalation valve with a 360° opening ensures very low breathing resistance and a cooling effect climate inside the mask.



5
The upper face seal offers both a more secure positioning of the mask and increased wearer comfort.

uvex silv-Air c

Filtering face masks, protection class FFP1



uvex silv-Air 3100

- particle-filtering folding mask
- seamless headband and flexible, adjustable nose clip
- comfortable sealing lip in nose area for secure fit

| | | |
|---------------------------------|---|---------|
| uvex silv-Air 3100 | | |
| Art. no. | 8733100 | 8753100 |
| Version | FFP1 NR D folding mask without valve | |
| Colour | white | |
| Order quantity multiple/ | 30 PC | BG |
| Order unit | | |
| Content | 30 PC, individually packed in BOX 3 PC, individually packed in BG | |

uvex silv-Air 3110

- particle-filtering folding mask with exhalation valve
- Comfortable sealing lip in nose area for secure fit
- seamless headband and flexible, adjustable nose clip
- exhalation valve to further reduce breathing resistance, by helping to minimise moisture build up inside the mask

| | | |
|---------------------------------|---|---------|
| uvex silv-Air 3110 | | |
| Art. no. | 8733110 | 8753110 |
| Version | FFP1 NR D folding mask with valve | |
| Colour | white | |
| Order quantity multiple/ | 15 PC | BG |
| Order unit | | |
| Content | 15 PC, individually packed in BOX 3 PC, individually packed in BG | |



uvex silv-Air 2100

- particle-filtering preformed mask
- seamless headband and nose clip for a comfortable, secure fit
- comfortable sealing lip in nose area for secure fit

| | | |
|---------------------------------|---|---------|
| uvex silv-Air 2100 | | |
| Art. no. | 8732100 | 8752100 |
| Version | FFP1 NR D preformed mask without valve | |
| Colour | white | |
| Order quantity multiple/ | 20 PC | BG |
| Order unit | | |
| Content | 20 PC, packed in BOX 3 PC, packed in BG | |

uvex silv-Air 2110

- particle-filtering preformed mask with exhalation valve
- seamless headband and nose clip for a comfortable, secure fit
- comfortable sealing lip in nose area for secure fit
- exhalation valve to further reduce breathing resistance, by helping to minimise moisture build up inside the mask

| | | |
|---------------------------------|---|---------|
| uvex silv-Air 2110 | | |
| Art. no. | 8732110 | 8752110 |
| Version | FFP1 NR D preformed mask with valve | |
| Colour | white | |
| Order quantity multiple/ | 15 PC | BG |
| Order unit | | |
| Content | 15 PC, packed in BOX 3 PC, packed in BG | |



uvex silv-Air c

Filtering face masks, protection class FFP2



8733200
8753200



8733210
8753210



8733220

uvex silv-Air 3200

- particle-filtering folding mask
- seamless headband and flexible, adjustable nose clip
- comfortable sealing lip in nose area for secure fit

uvex silv-Air 3210

- particle-filtering folding mask with exhalation valve
- seamless headband and flexible, adjustable nose clip
- comfortable sealing lip in nose area for secure fit
- exhalation valve to further reduce breathing resistance, by helping to minimise moisture build up inside the mask

uvex silv-Air 3220

- particle-filtering folding mask with exhalation valve
- additional activated carbon filter against odours, gases and vapours below threshold
- seamless headband and flexible, adjustable nose clip
- comfortable sealing lip in nose area for secure fit
- exhalation valve to further reduce breathing resistance, by helping to minimise moisture build up inside the mask

| | uvex silv-Air 3200 | | uvex silv-Air 3210 | | uvex silv-Air 3220 |
|---------------------------------|--------------------------------------|---------|-----------------------------------|---------|--|
| Art. no. | 8733200 | 8753200 | 8733210 | 8753210 | 8733220 |
| Version | FFP2 NR D folding mask without valve | | FFP2 NR D folding mask with valve | | FFP2 NR D folding mask with valve and carbon |
| Colour | white | | white | | silver |
| Order quantity multiple/ | 30 PC | BG | 15 PC | BG | 15 PC |
| Order unit | 30 PC, individually packed in BOX | | 15 PC, individually packed in BOX | | 15 PC, individually packed in BOX |



8732200
8752200



8732210
8752210



8732220

uvex silv-Air 2200

- particle-filtering preformed mask
- seamless headband and flexible, adjustable nose clip for a comfortable, secure fit
- comfortable sealing lip in nose area for secure fit

uvex silv-Air 2210

- particle-filtering preformed mask with exhalation valve
- seamless headband and flexible, adjustable nose clip for a comfortable, secure fit
- comfortable sealing lip in nose area for secure fit
- exhalation valve to further reduce breathing resistance, by helping to minimise moisture build up inside the mask

uvex silv-Air 2220

- particle-filtering preformed mask with exhalation valve
- additional activated carbon filter against odours, gases and vapours below threshold
- Seamless headband and flexible, adjustable nose clip for a comfortable, secure fit
- comfortable sealing lip in nose area for secure fit
- exhalation valve to further reduce breathing resistance, by helping to minimise moisture build up inside the mask

| | uvex silv-Air 2200 | | uvex silv-Air 2210 | | uvex silv-Air 2220 |
|---------------------------------|--|---------|-------------------------------------|---------|--|
| Art. no. | 8732200 | 8752200 | 8732210 | 8752210 | 8732220 |
| Version | FFP2 NR D preformed mask without valve | | FFP2 NR D preformed mask with valve | | FFP2 NR D preformed mask with valve and carbon |
| Colour | white | | white | | silver |
| Order quantity multiple/ | 20 PC | BG | 15 PC | BG | 15 PC |
| Order unit | 20 PC, packed in BOX | | 15 PC, packed in BOX | | 15 PC, packed in BOX |

uvex silv-Air c

Filtering face masks, protection class FFP3



8733310
8753311

uvex silv-Air 3310

- particle-filtering folding mask with exhalation valve
- adjustable headband and flexible, adjustable nose clip for a comfortable, secure fit
- comfortable, all-around sealing lip for secure fit
- exhalation valve to further reduce breathing resistance, by helping to minimise moisture build up inside the mask

| | | |
|--------------------------|-----------------------------------|---------------------------------|
| uvex silv-Air 3310 | | |
| Art. no. | 8733310 | 8753311 |
| Version | FFP3 NR D folding mask with valve | |
| Colour | white | |
| Order quantity multiple/ | 15 PC | BG |
| Order unit | | |
| Content | 15 PC, individually packed in BOX | 2 PC, individually packed in BG |



8732310
8752311

uvex silv-Air 2310

- particle-filtering preformed mask with exhalation valve for **larger face shapes**
- four-point headband attachment and flexible, adjustable nose clip for a comfortable, secure fit
- very soft, all-around sealing lip for optimal wearer comfort and secure fit
- exhalation valve to further reduce breathing resistance, by helping to minimise moisture build up inside the mask



8732312
8752312

uvex silv-Air 2312

- particle-filtering preformed mask with exhalation valve – ergonomically adapted for **smaller to medium-sized face shapes**
- four-point headband attachment and flexible, adjustable nose clip for a comfortable, secure fit
- very soft, all-around sealing lip for optimal wearer comfort and secure fit
- exhalation valve to further reduce breathing resistance, by helping to minimise moisture build up inside the mask

| | | | | |
|--------------------------|---|--------------------|---|--------------------|
| | uvex silv-Air 2310 | | uvex silv-Air 2312 | |
| Art. no. | 8732310 | 8752311 | 8732312 | 8752312 |
| Version | FFP3 NR D preformed mask with valve – large version | | FFP3 NR D preformed mask with valve – small version | |
| Colour | white | | white | |
| Order quantity multiple/ | 15 PC | BG | 15 PC | BG |
| Order unit | | | | |
| Content | 15 PC, packed in BOX | 2 PC, packed in BG | 15 PC, packed in BOX | 2 PC, packed in BG |

uvex silv-Air Breathing protection

Quick overview of product features



The **360° exhalation valve** considerably reduces breathing resistance and build-up of heat and moisture in the mask.



The masks are **individually** packed and meet the highest standards of hygiene.



Comfortable all-round sealing lip
The soft sealing lip guarantees a secure, comfortable sealed positioning of the mask.



Carbon inside
The additional activated carbon layer incorporated in the filter material reduces unpleasant odours.



Soft sealing lip in the nose and chin area for a secure and comfortable fit.



The **3D nose area** ensures a comfortable fit, low leakage and prevents misting of uncoated eyewear.



Comfortable sealing lip in the nose area
The soft sealing lip in the nose area guarantees a secure, pressure-free fit.



High performance climate management
The mask offers extremely low breathing resistance due to the filter chambers connected with the inhalation valve. The climate management of the high performance mask guarantees optimum wearer comfort.



Comfort nose clip
The mask is fitted with a high-quality nose clip making it individually adjustable.



R labelling
The mask has been tested for reusability and has the required performance features for wearing during a second work shift.



Metal-free
The mask is completely metal-free and is manufactured entirely of skin-tolerant materials.



“NR” designation
The masks are not reusable and must therefore be disposed of after a work shift.



The **4-point headband attachment** allows an individual and secure fit, which can be perfectly adapted to meet the wearer's requirements.



D labelling
The mask has undergone additional dolomite dust testing and therefore affords excellent breathability, even in extremely dusty environments and during longer periods of use.

uvex silv-Air

Overview

| Art. no. | Name | Type | Features | Retail unit | Outer packaging Quantity in PC | Page |
|----------|-------------------------------------|---|----------|----------------|--------------------------------|------|
| 8701011 | uvex clear | Cleaning spray | | 1 can (360 ml) | 100 | 143 |
| 8707100 | uvex silv-Air 7100 | FFP1 preformed mask without valve | | 20 per box | 180 | 158 |
| 8707110 | uvex silv-Air 7110 | FFP1 preformed mask with valve | | 15 per box | 135 | 158 |
| 8707200 | uvex silv-Air 7200 | FFP2 preformed mask without valve | | 20 per box | 180 | 159 |
| 8707210 | uvex silv-Air 7210 | FFP2 preformed mask with valve | | 15 per box | 135 | 159 |
| 8707212 | uvex silv-Air 7212 | FFP2 preformed mask with valve | | 15 per box | 135 | 156 |
| 8707220 | uvex silv-Air 7220 with carbon | FFP2 preformed mask with valve | | 15 per box | 135 | 159 |
| 8707232 | uvex silv-Air 7232 High-Performance | FFP2 preformed mask with three-chamber system | | 3 per box | 36 | 155 |
| 8707233 | uvex silv-Air 7233 High-Performance | FFP2 preformed mask with three-chamber system | | 3 per box | 36 | 155 |
| 8707310 | uvex silv-Air 7310 | FFP3 preformed mask with valve | | 5 per box | 60 | 160 |
| 8707312 | uvex silv-Air 7312 | FFP3 preformed mask with valve | | 5 per box | 60 | 156 |
| 8707317 | uvex silv-Air 7317 | FFP3 preformed mask with valve | | 5 per box | 60 | 156 |
| 8707318 | uvex silv-Air 7317 | FFP3 preformed mask with valve | | 120 pieces | 120 | 156 |
| 8707320 | uvex silv-Air 7320 with carbon | FFP3 preformed mask with valve | | 5 per box | 60 | 160 |
| 8707330 | uvex silv-Air 7330 High-Performance | FFP3 preformed mask with three-chamber system | | 3 per box | 36 | 155 |
| 8707333 | uvex silv-Air 7333 High-Performance | FFP3 preformed mask with three-chamber system | | 3 per box | 36 | 155 |
| 8708103 | uvex silv-Air 8103 | FFP1 folding mask without valve | | 20 per box | 480 | 158 |
| 8708113 | uvex silv-Air 8113 | FFP1 folding mask with valve | | 15 per box | 360 | 158 |
| 8708203 | uvex silv-Air 8203 | FFP2 folding mask without valve | | 20 per box | 480 | 159 |
| 8708213 | uvex silv-Air 8213 | FFP2 folding mask with valve | | 15 per box | 360 | 159 |
| 8708313 | uvex silv-Air 8313 | FFP3 folding mask with valve | | 15 per box | 360 | 160 |
| 8732100 | uvex silv-Air 2100 | FFP1 preformed mask without valve | | 20 per box | 240 | 163 |
| 8752100 | uvex silv-Air 2100 | FFP1 preformed mask without valve | | 3 per box | 60 | 163 |
| 8732110 | uvex silv-Air 2110 | FFP1 preformed mask with valve | | 15 per box | 180 | 163 |
| 8752110 | uvex silv-Air 2110 | FFP1 preformed mask with valve | | 3 per box | 60 | 163 |
| 8732200 | uvex silv-Air 2200 | FFP2 preformed mask without valve | | 20 per box | 240 | 164 |
| 8752200 | uvex silv-Air 2200 | FFP2 preformed mask without valve | | 3 per box | 60 | 164 |
| 8732210 | uvex silv-Air 2210 | FFP2 preformed mask with valve | | 15 per box | 180 | 164 |
| 8752210 | uvex silv-Air 2210 | FFP2 preformed mask with valve | | 3 per box | 60 | 164 |
| 8732220 | uvex silv-Air 2220 with carbon | FFP2 preformed mask with valve | | 15 per box | 180 | 164 |
| 8732310 | uvex silv-Air 2310 | FFP3 preformed mask with valve | | 15 per box | 180 | 165 |
| 8752311 | uvex silv-Air 2310 | FFP3 preformed mask with valve | | 2 per box | 20 | 165 |
| 8732312 | uvex silv-Air 2312 | FFP3 preformed mask with valve | | 15 per box | 180 | 165 |
| 8752312 | uvex silv-Air 2312 | FFP3 preformed mask with valve | | 2 per box | 20 | 165 |
| 8733100 | uvex silv-Air 3100 | FFP1 folding mask without valve | | 30 per box | 360 | 163 |
| 8753100 | uvex silv-Air 3100 | FFP1 folding mask without valve | | 3 per box | 60 | 163 |
| 8733110 | uvex silv-Air 3110 | FFP1 folding mask with valve | | 15 per box | 180 | 163 |
| 8753110 | uvex silv-Air 3110 | FFP1 folding mask with valve | | 3 per box | 60 | 163 |
| 8733200 | uvex silv-Air 3200 | FFP2 folding mask without valve | | 30 per box | 360 | 164 |
| 8753200 | uvex silv-Air 3200 | FFP2 folding mask without valve | | 3 per box | 60 | 164 |
| 8733210 | uvex silv-Air 3210 | FFP2 folding mask with valve | | 15 per box | 180 | 164 |
| 8753210 | uvex silv-Air 3210 | FFP2 folding mask with valve | | 3 per box | 60 | 164 |
| 8733220 | uvex silv-Air 3220 with carbon | FFP2 folding mask with valve | | 15 per box | 180 | 164 |
| 8733310 | uvex silv-Air 3310 | FFP3 folding mask with valve | | 15 per box | 180 | 165 |
| 8753311 | uvex silv-Air 3310 | FFP3 folding mask with valve | | 2 per box | 60 | 165 |
| 8765100 | uvex silv-Air 5100 | FFP1 folding mask without valve | | 30 per box | 480 | 150 |
| 8775100 | uvex silv-Air 5100 | FFP1 folding mask without valve | | 3 per box | 60 | 150 |



uvex silv-Air

Overview

| Art. no. | Name | Type | Features | Retail unit | Outer packaging Quantity in PC | Page |
|----------|---------------------------------|---------------------------------|----------|-------------|--------------------------------|------|
| 8765101 | uvex silv-Air 5100+ | FFP1 folding mask without valve | | 30 per box | 480 | 150 |
| 8775101 | uvex silv-Air 5100+ | FFP1 folding mask without valve | | 3 per box | 60 | 150 |
| 8765110 | uvex silv-Air 5110 | FFP1 folding mask with valve | | 15 per box | 240 | 150 |
| 8775110 | uvex silv-Air 5110 | FFP1 folding mask with valve | | 3 per box | 60 | 150 |
| 8765111 | uvex silv-Air 5110+ | FFP1 folding mask with valve | | 15 per box | 240 | 150 |
| 8775111 | uvex silv-Air 5110+ | FFP1 folding mask with valve | | 3 per box | 60 | 150 |
| 8765200 | uvex silv-Air 5200 | FFP2 folding mask without valve | | 30 per box | 480 | 151 |
| 8775200 | uvex silv-Air 5200 | FFP2 folding mask without valve | | 3 per box | 60 | 151 |
| 8765201 | uvex silv-Air 5200+ | FFP2 folding mask without valve | | 30 per box | 480 | 151 |
| 8775201 | uvex silv-Air 5200+ | FFP2 folding mask without valve | | 3 per box | 60 | 151 |
| 8765210 | uvex silv-Air 5210 | FFP2 folding mask with valve | | 15 per box | 240 | 151 |
| 8775210 | uvex silv-Air 5210 | FFP2 folding mask with valve | | 3 per box | 60 | 151 |
| 8765211 | uvex silv-Air 5210+ | FFP2 folding mask with valve | | 15 per box | 240 | 151 |
| 8775211 | uvex silv-Air 5210+ | FFP2 folding mask with valve | | 3 per box | 60 | 151 |
| 8765221 | uvex silv-Air 5220+ with carbon | FFP2 folding mask with valve | | 15 per box | 240 | 151 |
| 8775221 | uvex silv-Air 5220+ with carbon | FFP2 folding mask with valve | | 3 per box | 60 | 151 |
| 8765310 | uvex silv-Air 5310 | FFP3 folding mask with valve | | 15 per box | 240 | 152 |
| 8775310 | uvex silv-Air 5310 | FFP3 folding mask with valve | | 3 per box | 60 | 152 |
| 8765311 | uvex silv-Air 5310+ | FFP3 folding mask with valve | | 15 per box | 240 | 152 |
| 8775311 | uvex silv-Air 5310+ | FFP3 folding mask with valve | | 3 per box | 60 | 152 |
| 8765321 | uvex silv-Air 5320+ with carbon | FFP3 folding mask with valve | | 15 per box | 240 | 152 |
| 8775321 | uvex silv-Air 5320+ with carbon | FFP3 folding mask with valve | | 3 per box | 60 | 152 |



Disposable
Protective Clothing

Disposable Protection Clothing

Guide to standards and products

PPE Regulation EU 2016/425

The conditions for the sale of personal protective equipment (PPE) and the fundamental safety requirements that this PPE must meet are regulated in the PPE Regulation EU 2016/425.

If the requirements set out in the directive are met, the product is eligible for CE marking and can be offered for sale on the European internal market.

Depending on the level of risk that protective clothing is designed to protect against, PPE is assigned to one of three categories:

- Category I:** Simple protective equipment, low risk
- Category II:** Protective clothing that protects the wearer against hazards; PPE that does not fall into category 1 or category 3
- Category III:** Protective clothing that protects the wearer against potentially fatal hazards or serious and irreversible damage to health, high risk

DIN EN ISO 13688 Protective clothing – general requirements

DIN EN ISO 13688 defines the general requirements that apply to protective clothing in terms of ergonomics, innocuousness, ageing, size designation, compatibility and marking, as well as the information to be supplied by the manufacturer with the protective clothing. This European standard is a reference standard that is referred to in all other specific protective clothing standards. It can therefore only be applied in conjunction with a specific standard.

Detailed information on the standards can be found at uvex-safety.com.

To simplify the process of selecting appropriate protective clothing, the European Union has defined harmonised standards for different protection classes (also called types) for chemical protection – Category III. The protection type is confirmed by certification and indicates the kind of exposure (dust, liquid, gas) for which the suit is suitable. The attainment of the individual types only ensures the minimum requirements necessary for certification. Please refer to our technical datasheets for details of the individual tests.

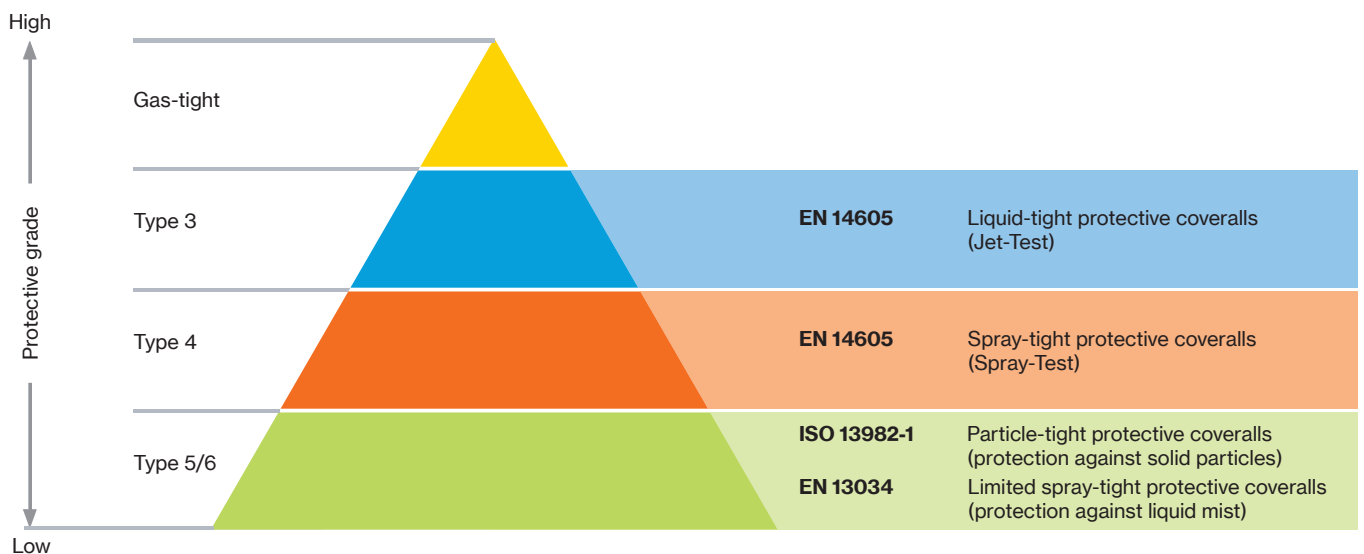

Chemical protection is always classified as category III.

Disposable Protection Clothing

Guide to standards and products

| | | uvex 5/6 air | uvex 5/6 air | uvex 5/6 comfort | uvex 5/6 classic | uvex 4B | uvex 3B chem light | uvex 3B chem classic |
|-------------|--|--------------|--------------|------------------|------------------|---------|--------------------|----------------------|
| | | 98173 | 89976 | 98710 | 98449 | 98375 | 89843 | 89880 |
| EN 14605 | Liquid-tight coveralls | | | | | | ■ | ■ |
| EN 14605 | Spray-tight coveralls | | | | | ■ | ■ | ■ |
| EN 13034 | Limited spray-tight coveralls (protection against liquid mist) | ■ | ■ | ■ | ■ | ■ | | |
| ISO 13982-1 | Particle-tight coveralls (protection against solid particles) | ■ | ■ | ■ | ■ | ■ | ■ | ■ |
| EN 1149-5 | Protective clothing with antistatic properties (antistatic function only guaranteed if air humidity > 25%) | ■ | ■ | ■ | ■ | ■ | ■ | ■ |
| EN 14126 | Protective clothing against infective agents | | | | ■ | ■ | ■ | ■ |
| EN 1073-2 | Protective clothing against particulate radioactive contamination (no protection against radioactive rays) | ■ | ■ | | ■ | ■ | ■ | ■ |
| DIN 32781 | Protective clothing against pesticides | | | | | ■ | | |

For more detailed information, please see the relevant certificates, technical data sheets or the endorsement on the product!

Defining environmental conditions

Are you exposed to dusty, damp or wet conditions during your work?

To make it easier for you to select the right clothing for the job, we've categorised our overalls depending on their suitability for these environments. The bars indicate how suitable the product is for each setting.

We also provide information on breathability so that you can take wearer comfort into account in your decision.

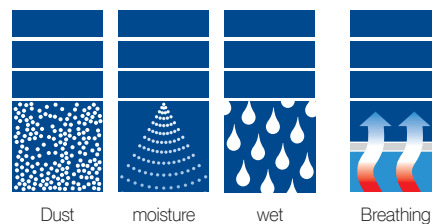

Identifying additional characteristics

In some work environments, there are additional requirements that you will need to take into account. These symbols indicate whether the items are free from silicone and paint wetting impairment substances.



uvex

uvex 3B chem classic



Areas of application:

- handling organic and inorganic chemicals
- cleaning and maintenance work
- chemical and pharmaceutical industries
- food industry
- remediation of soil contamination and dismantling
- industrial cleaning and maintenance
- tank cleaning
- work with paints and varnishes
- disposal of hazardous materials
- agricultural industry
- waste water treatment and drainage construction
- waste management
- disaster response and emergency services
- veterinary medicine and disease control
- oil and petrochemicals

uvex 3B chem classic

Disposable coverall chemical protection Type 3B



89880

uvex 3B chem classic

General features:

- highly durable material combined with ultrasonically welded and taped seams ensure an barrier and maximum safety
- extremely lightweight and durable material
- skin-friendly textile grip on inside

Protection features:

- offers protection against a wide range of chemicals
- optimal protection thanks to self-adhesive zipper flap

Comfort features:

- elasticated waistband, elasticated bands on hood, arms and legs for a perfect fit
- middle finger loops prevent sleeves sliding up the arm

| | |
|------------------------|---|
| uvex 3B chem classic | |
| Art. no. | 89880 |
| Material | polypropylene spunbond, laminated with polypropylene film |
| Colour | yellow |
| Sizes | S to 3XL |
| Order unit | PC |
| Outer packaging | 25 PC per CT |

Certified in acc. with

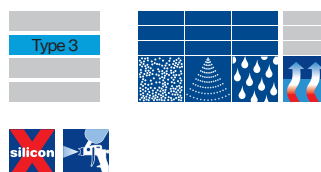
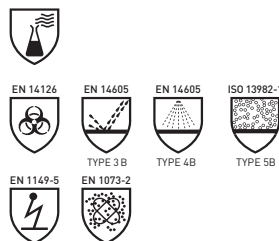

uvex 3B chem classic Material Composition

The extremely light and tight spunbond-polypropylene-laminate provides an effective barrier against many organic and inorganic liquid chemicals. The mechanical strength of the material and the sealed, taped seams allow the uvex 3B classic to provide protection against the highest strains without reducing comfort.

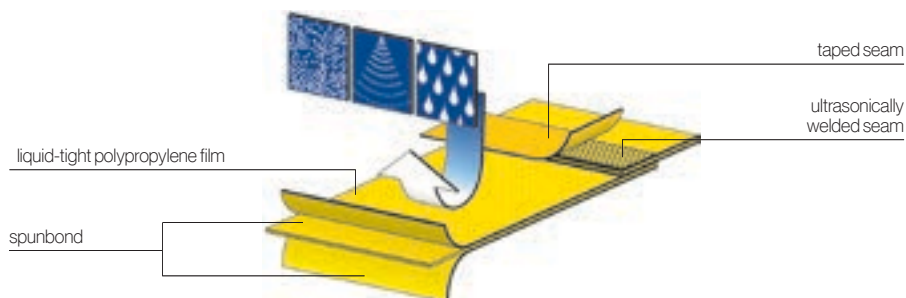

uvex-safety.com/en/overalls



Middle finger loops for firmly securing the sleeves.



Elasticated waistband for a customised fit.



Comfortable zipper puller and flap for increased protection.

uvex 3B chem light

Disposable coverall chemical protection Type 3B



89843

uvex 3B chem light

General features:

- light and highly flexible material for high wearer comfort with skin-friendly non-woven material inside

Protection features:

- ideal for cleaning work
- optimal protection thanks to self-adhesive zipper flap

Comfort features:

- elasticated waistband, elasticated bands on hood, arms and legs for optimal fit
- middle finger loops for securing the sleeves

Areas of application:

- handling low-concentration chemicals
- industrial and building cleaning
- ship building and automobile manufacture
- chemical and pharmaceutical industries
- handling paints and varnishes
- electronics
- handling and dismantling of asbestos
- remediation of contaminated sites
- livestock breeding and veterinary medicine
- waste management

| | |
|--------------------|---|
| uvex 3B chem light | |
| Art. no. | 89843 |
| Material | polypropylene spunbond laminated with polyethylene film |
| Colour | white, yellow |
| Sizes | S to 3XL |
| Order unit | PC |
| Outer packaging | 40 PC per CT |

Certified in acc. with

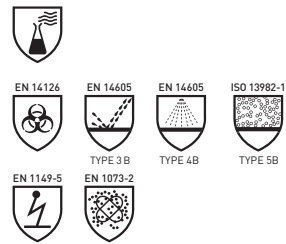

uvex 3B chem light Material Composition

The incredibly light and flexible spunbond film laminate is ideal for cleaning work and tasks involving the handling of low-concentration chemicals. The taped seams provide additional protection without sacrificing comfort.

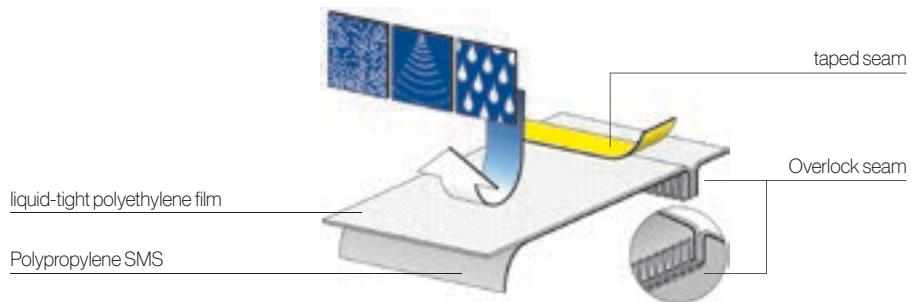

uvex-safety.com/en/overalls



Middle finger loops for firmly securing the sleeves.



Elasticated waistband for a customised fit.

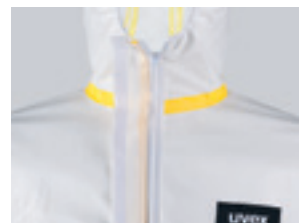

Convenient zip puller and adhesive flap for secure protection.

Type 3B disposable protective clothing

Performance parameters

The chemicals included in this list are examples only.

For a full overview for each individual garment, please consult the technical datasheets.

You can also search our Chemical Expert System (see page 190).

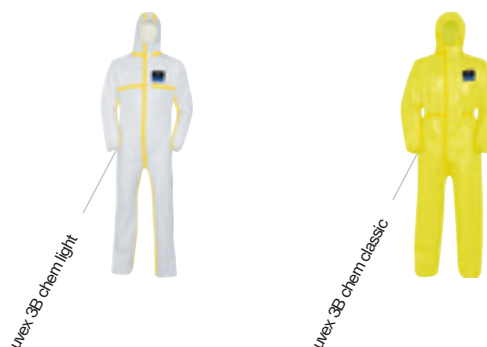

| Chemical | CAS no. | 89843 | 89880 |
|---------------------------------------|-----------|------------------------|------------------------|
| | | Class in acc. EN 14325 | Class in acc. EN 14325 |
| Acetone | 67-64-1 | 6 of 6 | 1 of 6 |
| Acetonitrile | 75-05-8 | 6 of 6 | 0 of 6 |
| Iron(III) chloride (aq., 45%) | 7705-08-0 | – | 6 of 6 |
| Hydrofluoric acid (aq., 49%) | 7664-39-3 | 6 of 6 | 6 of 6 |
| Hydrofluoric acid (aq., 71 to 75%) | 7664-39-3 | – | 5 of 6 |
| Hydrofluoric acid in urea (62 to 64%) | 7664-39-3 | – | 2 of 6 |
| Formaldehyde (aq., 10%) | 50-00-0 | – | 6 of 6 |
| Isopropanol | 67-63-0 | 6 of 6 | 6 of 6 |
| Methanol | 67-56-1 | 6 of 6 | 6 of 6 |
| Sodium hydroxide, 50% | 1310-73-2 | 6 of 6 | 6 of 6 |
| Nitric acid, 69.5% | 7697-37-2 | – | 6 of 6 |
| Hydrochloric acid (aq., 37%) | 7647-01-0 | 5 of 6 | 6 of 6 |
| Sulphuric acid, 96% | 7664-93-9 | 6 of 6 | 6 of 6 |
| Hydrogen peroxide | 7722-84-1 | 6 of 6 | 6 of 6 |



The information provided in the table was obtained in tests conducted under laboratory conditions (at temperatures of 21 ± 2°C). As additional stresses, such as higher temperatures and mechanical influences, are often present in practice, these values serve as a guide only. The information is provided without obligation and is not intended to replace your own suitability tests.



uvex 4B

Protection against pesticides – DIN 32781

In farming and forestry applications, workers are repeatedly exposed to hazardous chemical and biological substances.

Depending on the type of application, the duration of the exposure and the specific effects of the hazardous substance, it may be necessary to wear personal protective equipment.

In addition to respiratory protection and gloves, appropriate chemical protection clothing is an important component of the wearer's protective equipment.

The performance requirements for chemical protection clothing worn when handling or applying diluted pesticide solutions are set out in DIN 32781. As part of the certification process, the garments are tested for their resistance to specific substances; physical material properties and wearer comfort are also important considerations.

When uvex 4B garments were spray-tested with the five pesticides listed in the standard, the clothing showed no signs of penetration by the substances.



Typical applications that may require chemical protection clothing include:

- the mixing and filling of undiluted concentrates
- spraying heavily diluted mixtures
- exposure due to drift during fine particle aerosol application
- exposure due to intensive contact with treated foliage



uvex 4B

Disposable coverall chemical protection type 4B



98375

uvex 4B

General features:

- light and highly flexible material for high wearer comfort lined with skin-friendly non-woven material inside

Protection features:

- taped seams for optimal protection
- self-adhesive zipper flap for optimal protection

Comfort features:

- elasticated waistband, elasticated bands on hood, arms and legs for optimal fit
- middle finger loops prevent sleeves sliding up the arm

Areas of application:

- low-pressure industrial cleaning and building cleaning
- ship building and automobile manufacture
- chemical and pharmaceutical industries
- handling paints and varnishes
- agriculture and horticulture
- pest control
- electronics
- work with asbestos and dismantling
- remediation of contaminated sites
- pharmaceutical industry and laboratories
- sampling
- livestock breeding and veterinary medicine
- waste management

| | |
|------------------------|--|
| uvex 4B | |
| Art. no. | 98375 |
| Material | polypropylene spunbond, laminated with polyethylene film |
| Colour | white, orange |
| Sizes | S to 3XL |
| Order unit | PC |
| Outer packaging | 40 PC per CT |

Certified in acc. with

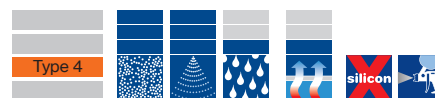
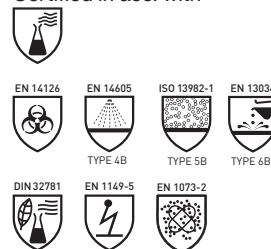

uvex 4B Material Composition

The microporous spray-tight spunbond-polyethylene-laminate enables the uvex 4B to provide both protection and breathability. The taped seams provide outstanding protection against liquid aerosols and solid particles while the spunbond material inside makes it comfortable to wear.



uvex-safety.com/en/overalls



Stitched and taped seams. Optimum protection against penetration by liquid aerosols and solid particles.



Middle finger loops for firmly securing the sleeves.



Three-part hood for optimum fit.

uvex 5/6 classic

Disposable coverall chemical protection Type 5/6



98449



uvex 5/6 classic

General features:

- extremely lightweight and breathable material guarantees an excellent combination of comfort and safety
- skin-friendly and soft non-woven material on the inside

Protection features:

- self-adhesive zipper flap for optimal protection

Comfort features:

- elasticated waistband, elasticated bands on hood, arms and legs for a perfect fit
- middle finger loops prevent sleeves sliding up the arm

Areas of application:

- handling chemicals in dust and powder form
- varnishing and protection against paint splashes
- fibreglass production and processing
- industrial cleaning and maintenance
- automotive industry
- grinding and polishing
- cement manufacture
- mining and quarrying
- demolition and refurbishment
- working with asbestos
- wood and metal processing
- construction industry
- pharmaceutical industry

| | |
|------------------------|--|
| uvex 5/6 classic | |
| Art. no. | 98449 |
| Material | polypropylene spunbond, laminated with polyethylene film |
| Colour | white |
| Sizes | S to 3XL |
| Order unit | PC |
| Outer packaging | 50 PC per CT |

Certified in acc. with

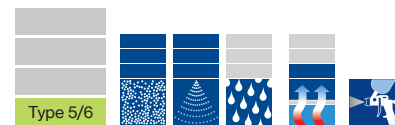

uvex 5/6 classic Material Composition

The uvex 5/6 classic is made of an extremely light, microporous spunbond polyethylene laminate. Wearers are comfortable due to the soft, skin friendly material and combined with durable seams, providing a high level of protection against particles and liquid mist.

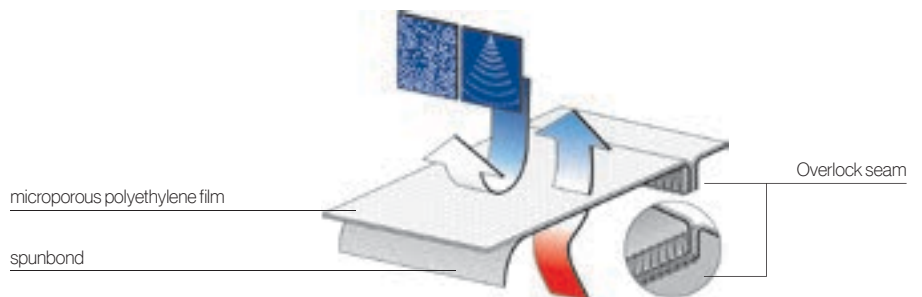

uvex-safety.com/en/overalls



Three-part hood for optimum fit and unhindered vision.

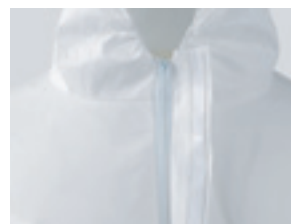

Two-way zipper with adhesive placket for added safety.



Elasticated waistband for a perfect fit.

uvex 5/6 comfort

Disposable coverall chemical protection Type 5/6



98710

uvex 5/6 comfort

General features:

- the combination of polyethylene laminate and a SMS back section provides a high level of moisture management, without reducing protection
- suitable for cleanroom environments Class 8 in accordance with ISO 14644-1

Protection features:

- bound seams in contrasting colour
- self-adhesive zipper flap for optimal protection

Comfort features:

- optimal fit with elasticated waistband, elasticated bands on the hood, arms and legs
- middle finger loops prevent sleeves sliding up the arm

Areas of application:

- handling chemicals in dust and powder form
- varnishing and protection against paint splashes
- fibreglass production and processing
- industrial cleaning and maintenance
- automotive industry
- grinding and polishing
- cement manufacture
- mining and quarrying
- demolition and refurbishment
- working with asbestos
- wood and metal processing
- construction industry
- cleanroom applications
- pharmaceutical industry

| | |
|------------------------|--|
| uvex 5/6 comfort | |
| Art. no. | 98710 |
| Material | Main material: polypropylene spunbond, laminated with polypropylene film back: SMS spunbond |
| Colour | white, lime |
| Sizes | M to 3XL |
| Order unit | PC |
| Outer packaging | 40 PC per CT |

Certified in acc. with

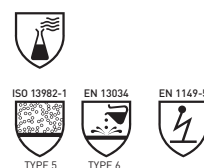

uvex 5/6 comfort Material Composition

The uvex 5/6 is a very light, microporous spunbond-polyethylene-laminate that, combined with spunbond (SMS) back section, ensures high breathability. Together with the bound seams it guarantees a high level of protection against liquid mist and solid particles.

Spunbond non-woven material

Meltblown non-woven material

Spunbond non-woven material

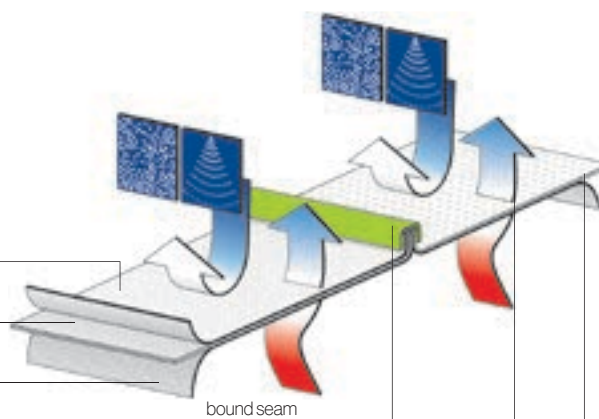

bound seam

microporous polyethylene film

polypropylene spunbond (SMS)



Bound seams, exterior in contrasting colour. Increased protection against penetration by solid particles and liquid splashes.



Middle finger loops for firmly securing the sleeves.



Breathable polyethylene laminate combined with an air permeable SMS back section to provide a high level of moisture management and breathability.



uvex-safety.com/en/overalls

uvex 5/6 air

Disposable coverall chemical protection Type 5/6



98173



uvex 5/6 air

General features:

- excellent moisture management
- ideal for warm working environments and extended periods of wear

Protection features:

- optimal protection in dusty environments
- self-adhesive zipper flap for optimal protection

Comfort features:

- optimal fit with elasticated waistband, elasticated bands on hood, arms and legs
- middle finger loops prevent sleeves sliding up the arm

Areas of application:

- handling chemicals in dust and powder form
- working with asbestos
- fibreglass, ceramic fibre and synthetic resin production and processing
- wood and metal processing
- construction industry
- automotive industry
- grinding and polishing
- cement manufacture
- mining and quarrying
- refurbishment and renovation
- pharmaceutical industry
- repair work

uvex 5/6 air

| | | |
|-----------------|------------------------|-------|
| Art. no. | 98173 | 89976 |
| Material | polypropylene spunbond | |
| Colour | white | blue |
| Sizes | S to 3XL | |
| Order unit | PC | |
| Outer packaging | 50 PC per CT | |

Certified in acc. with



uvex 5/6 air Material Composition

The uvex 5/6 air is made of a very light, porous and highly breathable SMS material which ensures excellent wearer comfort through optimum climate management. It also provides a strong barrier against dust exposure and liquid mist, providing reliable wearer protection.

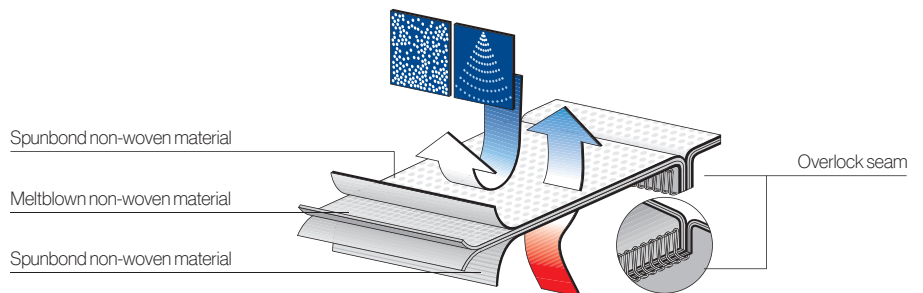

uvex-safety.com/en/overalls

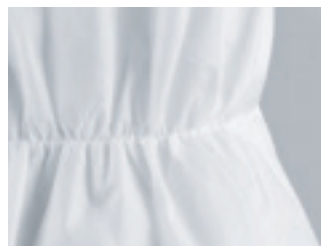

Elasticated waistband for a perfect fit.



Middle finger loops for firmly securing the sleeves.



Zipper with adhesive placket for added safety.

Disposable chemical protection

Accessories

Hood · Gauntlets · Overshoes · Overboots



9875200

| |
|--|
| Hood |
| Art. no. 9875200 |
| Sizes one size fits all |
| Version with velcro fastening |
| Material polypropylene spunbond, laminated with polyethylene film |
| Colour white |
| Order unit BG |
| Content 50 PC, loose |

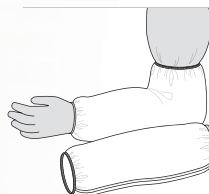

9875300

| |
|--|
| Gauntlets |
| Art. no. 9875300 |
| Sizes one size fits all |
| Version elasticated band on both ends |
| Material polypropylene spunbond, laminated with polyethylene film |
| Colour white |
| Order unit BG |
| Content 50 PR, loose |



9874946
9874948

| |
|--|
| Overshoes |
| Art. no. 9874946 9874948 |
| Sizes 42 to 46 46 to 48 |
| Version opening with elasticated band |
| Material polypropylene spunbond, laminated with polyethylene film |
| Colour white |
| Order unit BG |
| Content 100 PR, loose |



9875046

| |
|---|
| Overboot |
| Art. no. 9875046 |
| Sizes 42 to 46 |
| Version opening with elasticated band and tie |
| Material polypropylene spunbond, laminated with polypropylene film |
| Colour white |
| Order unit BG |
| Content 50 PR, loose |



8935346

| |
|---|
| Overboot |
| Art. no. 8935346 |
| Sizes 42 to 46 |
| Version opening with elasticated band and tie |
| Material polypropylene spunbond, laminated with polypropylene film |
| Colour yellow |
| Order unit BG |
| Content 30 PR, loose |



Disposable chemical protection type 5/6

Material and seam technology

The optimal material for every application

What level of barrier and protective effect do you require? What kind of environmental conditions are you exposed to? With overalls providing a wide range of protection levels and made from various material combinations, uvex offers the perfect solution for every situation – for maximum safety and wearer comfort.

uvex 5/6 laminate

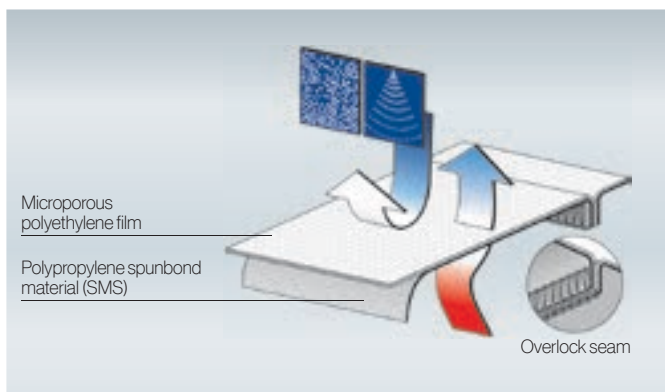

- soft touch
- “water-repellent” outer
- low breathability
- ideal for working in damp environments
- very good protection

- Used in:**
- uvex 5/6 classic
 - primary material in uvex 5/6 comfort

uvex 5/6 SMS/SMMS

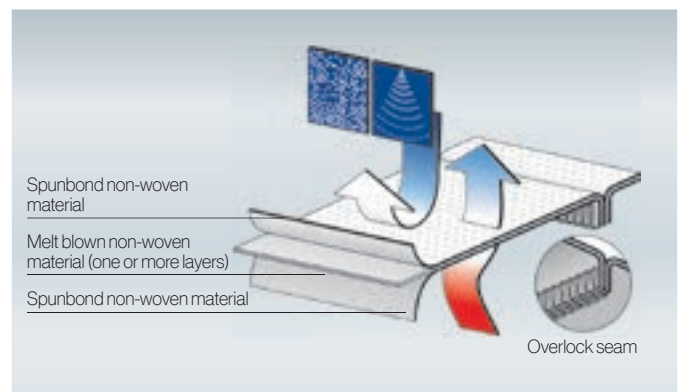

- exceptionally soft touch
- slightly “water-repellent” outer
- high breathability
- ideal for high-temperature environments
- good protection

- Used in:**
- uvex 5/6 air
 - back of uvex 5/6 comfort

Exceptionally hard-wearing seams

Testing



In seam strength tests performed in accordance with EN ISO 13935-2, mechanical pulling force is applied to the material to determine the level of force required to rip the seam.

Bound seam



To maintain a perfect seal over the garment, the quilted seam is covered with a contrasting strip. This design is used in uvex 5/6 comfort disposable overalls. Covering the seam with the cover strip produces a more secure seal.

Overlock seam

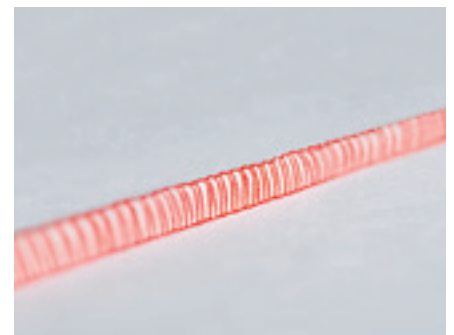

The internal overlock seam is up to 50% more resistant to stress and up to 50% more elastic than quilted seams. This design is used in uvex 5/6 classic and uvex 5/6 air garments.

Disposable chemical protection type 5/6

Individual climate comfort

Climate testing of uvex coveralls

Alongside the traditional selection criterion of standard requirements, wearer comfort is playing an increasingly significant role in the decision-making process, with climate control becoming an important performance characteristic.

To determine the climate control of the coveralls, the thermoregulation process was tested – the crucial factor here is the accruing moisture, as this forms the basis for transpiration.

The ambient temperatures in the climate test remain constant; only body temperature increases – depending on the breathability of the material.

Measuring the microclimate

In the test, the microclimate was measured in the layer structure of the coveralls and wearer according to the SWEATOR® test conditions: 21°C ambient temperature and 60% air humidity.

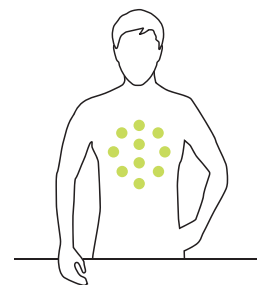

Measurement taken via 10 sensors on the chest and 14 on the back.



Accumulation of transpiration after 55 minutes = perceived heat build-up

How do the different materials influence wearer comfort?

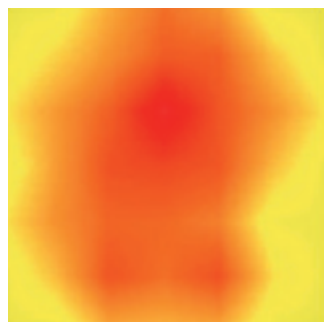

uvex 5/6 classic

The completely laminated coverall uvex 5/6 classic permits less evaporation and therefore leads to somewhat higher moisture levels. Compared to other coveralls, the uvex 5/6 classic exhibits the lowest level of breathability.

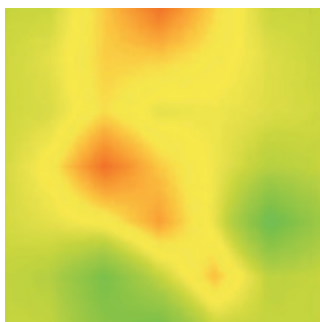

uvex 5/6 comfort

The material combination of SMS and laminate places the uvex 5/6 comfort coverall middle of the field in terms of climate control.

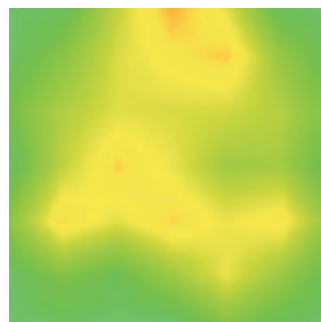

uvex 5/6 air

The uvex 5/6 air coverall made from highly breathable SMS material offers the best climate control properties. It is extremely breathable and impresses in the test thanks to lower temperatures and less moisture.

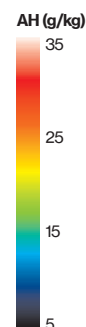

Which coverall suits which application?

The uvex 5/6 air or uvex 5/6 comfort are recommended for work at high temperatures or for tasks involving heavy physical exertion. The proven uvex 5/6 classic is well-suited to all applications involving lighter activities in normal climate conditions.

Disposable chemical protection

Protection against infectious diseases

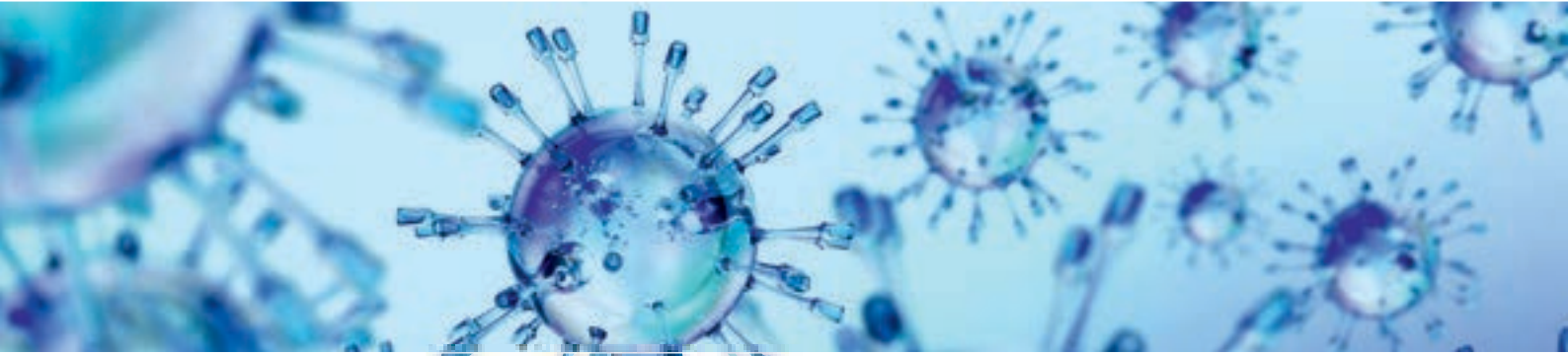

Workers may come into contact with biological substances in a wide range of situations. Appropriate personal protective equipment must be used to prevent potential infection.

Clothing designed to provide protection against infectious diseases establishes a physical barrier between the wearer's skin and the source of the infection, and prevents the disease from spreading to other people or environments.

Generally, micro-organisms such as bacteria, fungi and viruses are classed as biological substances. A detailed definition is provided in EU Directive 2000/54/EC. The crucial common denominator between all of these materials is that they can cause infections, trigger allergies, or produce a toxic effect.

Biological substances are placed in one of four categories depending on the infection risk they present:

Risk group 1:
Biological substances that are unlikely to cause disease in humans.

Risk group 2:
Biological substances that can cause human disease and might be a hazard to workers, but are unlikely to spread to the community; there is usually effective prophylaxis or treatment available.

Risk group 3:
Biological substances that can cause severe human disease and present a serious hazard to workers; they may present a risk of spreading to the community, but there is usually effective prophylaxis or treatment available.

Risk group 4:
Biological substances that cause severe human disease and are a serious hazard to workers; they may present a high risk of spreading to the community, and there is usually no effective prophylaxis or treatment available.

The risk groups of each biological substance are described in detail in the annex to EU Directive 2000/54/EC.

Typical applications in which workers may be exposed to infectious substances include:

- Waste water treatment and drainage work
- Waste disposal
- Agriculture
- Food industry
- Work that involves contact with animals and/or products of animal origin
- Healthcare, hospitals, emergency services

A detailed list of all biological substances that you may be exposed to in various applications, and the potential diseases associated with these substances, can be found in a number of publications, including the BGIA Report 1/2013.

Protective clothing in accordance with EN 14126:2003

The EN 14126 standard defines the performance requirements for clothing designed to protect against infectious diseases. The defined test procedures focus on the medium that contains the micro-organisms, such as fluids, aerosols or solid dust particles. Due to the heterogeneous nature of the micro-organisms, it is not possible to define performance criteria for them.

The tests stipulated by the standard relate only to the material; seam technologies are not taken into account. Taped seams provide a higher level of protection, as the micro-organisms are small enough to penetrate through the tiny needle holes along the seam. The entire protective suit must also be certified as chemical protection clothing (see page 170).

Wearing appropriate protective clothing does not provide complete, guaranteed protection against all chemical risks. It is also essential that you put on and remove the PPE correctly to ensure safety (see page 186). Any person who assists in the removal of the clothing is also exposed to the risk of contamination.

| Model | uvex 3B chem classic | uvex 3B chem light | uvex 4B | uvex 5/6 classic |
|---|----------------------|--------------------|---------|------------------|
| Art. no. | 89880 | 89843 | 98375 | 98449 |
| ISO/FDIS 16604/16603 Resistance to contaminated liquids | 6 of 6 | 6 of 6 | 6 of 6 | 6 of 6 |
| EN 14126 appendix A Resistance due to mechanical contact with substances containing contaminated liquids | 6 of 6 | 6 of 6 | 6 of 6 | 6 of 6 |
| ISO/DIS 22611 Resistance to contaminated liquid aerosols | 3 of 3 | 3 of 3 | 3 of 3 | 3 of 3 |
| ISO/DIS 22612 Resistance to contaminated solid particles | 3 of 3 | 3 of 3 | 3 of 3 | 3 of 3 |

Disposable chemical protection

Permeation

Your team's safety at the forefront

From light liquid splashes to hazardous chemicals and radioactive material – employees face various hazards in the course of their daily work.

For optimum protection of your team at all times, the breakthrough times of permeation must be taken into account for protective coveralls.

What is permeation?

Permeation is the process by which a chemical moves through an “imperious” material on a molecular level. The chemicals that accumulate on the outside penetrate the material in various chemical phases and in this way permeate into the inside.

● Chemical ■ Material ■ Skin

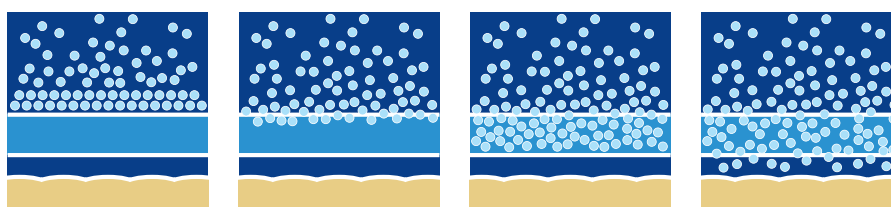

1. Adsorption
Accumulation of the liquid chemicals on the surface of the material.

2. Absorption
Penetration of the molecules into the material.

3. Diffusion
Penetration of the material on a molecular level based on the concentration gradient of the outside of the material into the inside.

4. Desorption
Leakage of molecules on the inside of the material following penetration.



Note individual factors

uvex protection clothing has undergone the required permeation tests according to ISO6529/EN 374-3.

Should the coveralls become contaminated, certain chemicals could penetrate the material – danger to the wearer cannot be ruled out.

More information on the breakthrough times of specific chemicals can be found in the technical datasheets or in the uvex Chemical Expert System (see page 190).

The breakthrough times were determined under laboratory conditions.

| EN class | Normalised breakthrough time (in min.) |
|----------|--|
| 0 | immediate (no class) |
| 1 | ≥ 10 |
| 2 | ≥ 30 |
| 3 | ≥ 60 |
| 4 | ≥ 120 |
| 5 | ≥ 240 |
| 6 | ≥ 480 |

As additional stresses, such as higher temperatures and mechanical influences, are often present in practice, this information serves as a guide only. Seams and zip pullers may have shorter breakthrough times particularly in the event of damage or previous wear.

Following contamination, wear or damage, the coverall is to be removed immediately and properly disposed of.

For further information on the test procedure used or for questions regarding individual permeation tests, please visit uvex-safety.com or contact uvex customer services directly at **0800-66 44 893** or **+49 (0) 911-97 36-0** from abroad. In the case of queries, please always provide the CAS number and concentration.

Disposable chemical protection

Guidelines for use

How to undress

In accordance with the ruling of the German Committee for Biological Agents (ABAS), the PPE should be put on and taken off as follows:

► Putting the PPE on:

- before putting the PPE on, check all parts to ensure none are missing or damaged
- remove jewellery and watches
- put on the suit and zip it up to the hips
- put on the boots
- put on the filtering face mask and check its tight fit
- put on the safety glasses
- pull the hood of the suit over your head and zip the suit until it is completely closed. To cover the chin and the zip, press the front flap into place
- put on the safety gloves and pull them over the cuff of the sleeves

► Taking the PPE off:

- disinfect the safety gloves but do not remove
- pull down the hood and pull the suit over the shoulders, turning it inside out down to the hips. At the same time, pull your arms out of the sleeves (a second person with safety gloves and a filtering face mask can help)
- take the suit completely off, removing the boots at the same time
- remove the safety gloves by pulling them inside out
- remove the glasses by drawing them forward from the back and place them in the designated place
- remove the filtering face mask in the same way
- disinfect your hands and finish off by thoroughly washing your hands, face and any other contaminated areas of skin with water and a disinfectant lotion



Disposable chemical protection

Instructions for use

How to make the right choice

To ensure a perfect fit and to guarantee maximum safety when working with hazardous substances, the uvex coveralls are available in a wide range of sizes. The table shows the body measurements and the corresponding uvex sizes. These size definitions are based on actual body measurements taken while wearing underwear but without wearing shoes.

These sizes differ from standard clothes sizes, so please always select uvex coveralls according to your actual body measurements and not your usual clothes sizes!

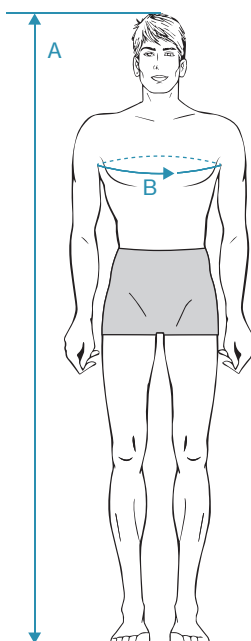

| Sizes | Body height in cm (A) | Chest measurement in cm (B) |
|-------|-----------------------|-----------------------------|
| S | 164–170 cm | 84–92 cm |
| M | 170–176 cm | 92–100 cm |
| L | 176–182 cm | 100–108 cm |
| XL | 182–188 cm | 108–116 cm |
| XXL | 188–194 cm | 116–124 cm |
| XXXL | 194–200 cm | 124–132 cm |

Using uvex disposable protective clothing

Prior to use it is essential to check the protective coverall for any damage e.g. broken seams, defective zipper closure or other visible defects which may impair its protection levels.

Storage

uvex disposable protective clothing must be stored in its original packaging in a dry place away from sunlight.

Disposal

The products must be disposed after use in accordance with respective rules and regulations. The products are only suitable for a single use.

Washing disposable suits

The disposable suits are only suitable for a single use and must not be washed.

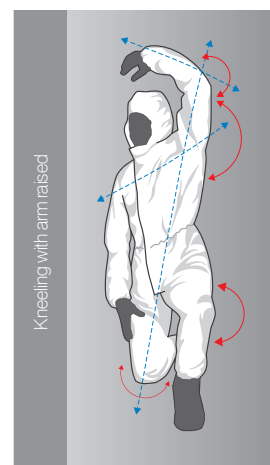
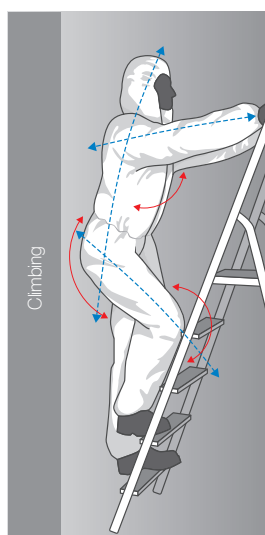
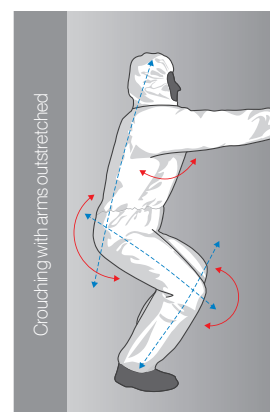
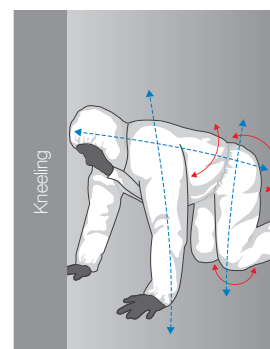
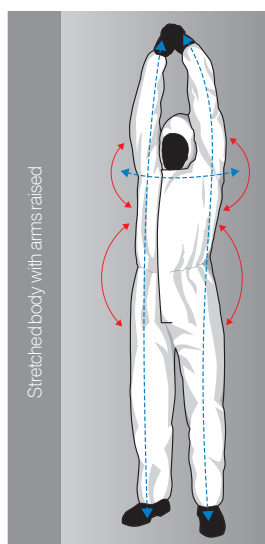
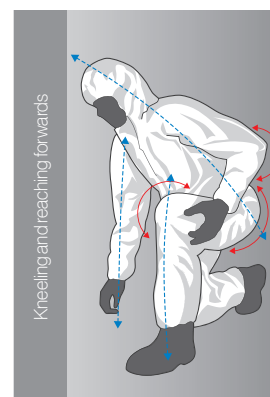
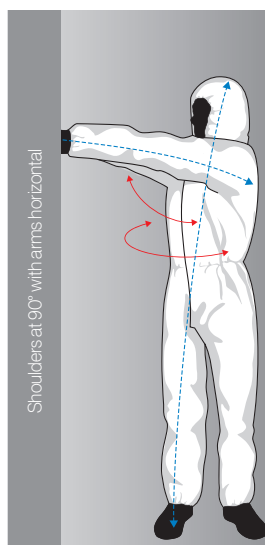

Disposable chemical protection

Selecting the right chemical protection clothing

In order to select appropriate chemical protection clothing for a specific application within your business, it is important to have your overalls tested by a trained safety officer.

Many chemicals can cause serious or irreversible injury to workers if they are not adequately protected. For this reason, chemical protection clothing must be chosen with the greatest care.

| | uvex 5/6 air | uvex 5/6 air | uvex 5/6 comfort | uvex 5/6 classic | uvex 4B | uvex 3B chem light | uvex 3B chem classic |
|--|--------------|--------------|------------------|------------------|---------|--------------------|----------------------|
| | 98173 | 89976 | 98710 | 98449 | 98375 | 89843 | 89880 |
| Working with chemicals in dust or powdered form | ■ | ■ | ■ | ■ | □ | | |
| Working with liquid chemicals at low concentrations | | | | | | ■ | |
| Working with organic and inorganic substances | | | | | | | ■ |
| Oil and petrochemicals | | | | | | | ■ |
| Fuel distribution | | | | | | | ■ |
| Tank cleaning | | | | | | | ■ |
| Waste water treatment and drainage work | | | | | | | ■ |
| Waste management | | | | | ■ | ■ | ■ |
| Disposal of hazardous substances | | | | | | | ■ |
| Food industry | | | | | | | ■ |
| Agriculture | | | □ | □ | ■ | | |
| Pest control | | | | | ■ | | |
| Livestock breeding and veterinary medicine | | | | | ■ | ■ | |
| Clean room applications | | | ■ | | | | |
| Handling paints and varnishes | | | | | | ■ | ■ |
| Pharmaceutical industry and laboratory work | □ | □ | ■ | ■ | ■ | ■ | ■ |
| Industrial and building cleaning | | | | | | ■ | □ |
| Cleaning and maintenance work (dry) | ■ | ■ | ■ | ■ | | | |
| Low-pressure industrial cleaning and building cleaning | | | | | ■ | | |
| Demolition and refurbishment | ■ | ■ | ■ | ■ | ■ | ■ | |
| Working with asbestos | ■ | ■ | ■ | ■ | □ | □ | |
| Fibreglass production and processing | ■ | ■ | ■ | ■ | | | |
| Quarrying and mining | ■ | ■ | ■ | ■ | | | |
| Cement manufacture | ■ | ■ | ■ | ■ | | | |
| Wood and metal processing | ■ | ■ | ■ | ■ | | | |
| Grinding and polishing | ■ | ■ | ■ | ■ | | | |
| Varnishing and protection against paint splashes | ■ | ■ | ■ | ■ | | | |

Disposable chemical protection

Selection guide – applications

► Please note

It is the responsibility of the user to decide which product is most suitable for the intended application. Under no circumstances can uvex accept responsibility for the incorrect application and use of these products.

For enquiries or additional information, please visit **uvex-safety.de** or contact our customer service department directly on **0800 6644893** (for calls from within Germany) or **+49 (0) 911 97360** (for calls from outside Germany). We will be happy to help.

This diagram is a simplification.

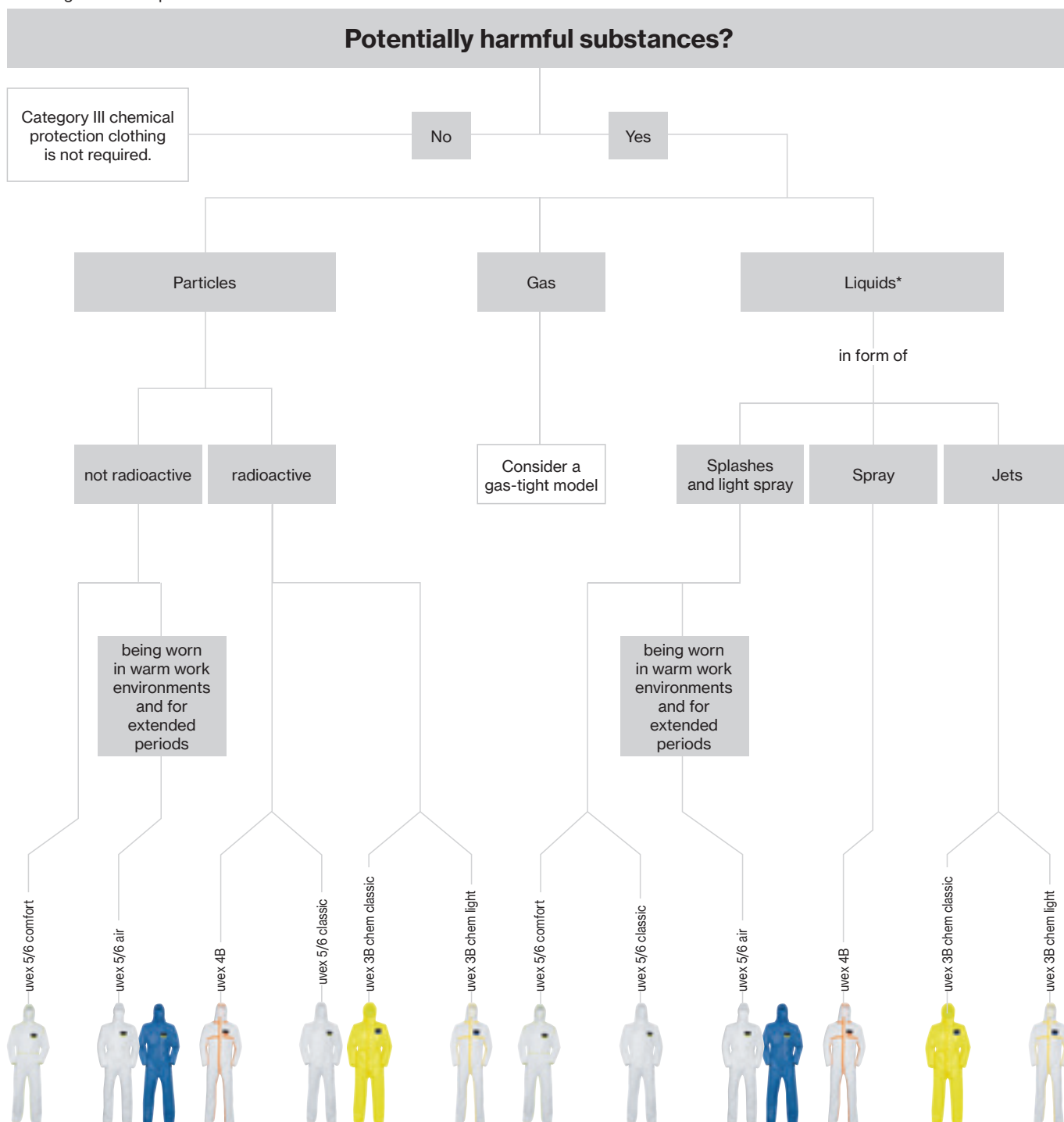

* Please note the permeation data (definition page 185).

uvex Chemical Expert System

Chemicals database online

As a leader of innovation, we place the highest demands on the products and services which we offer our customers. The uvex Chemical Expert System (CES) has been developed by experts for experts. It can be accessed anytime and anywhere in the world. This web-based tool helps you select the appropriate disposable safety clothing.

Online chemicals database

The uvex Chemical Expert System (CES) offers an extensive chemicals database for choosing the appropriate safety gloves for working with hazardous substances. As a user, you can create a personal permeation list or receive advice from our specialists. It only takes a few clicks of the mouse to find the right disposable safety clothing and chemical safety gloves to match your specific requirements.

<https://ces.uvex.de>



Entry page to chemicals database



Variety of different search options

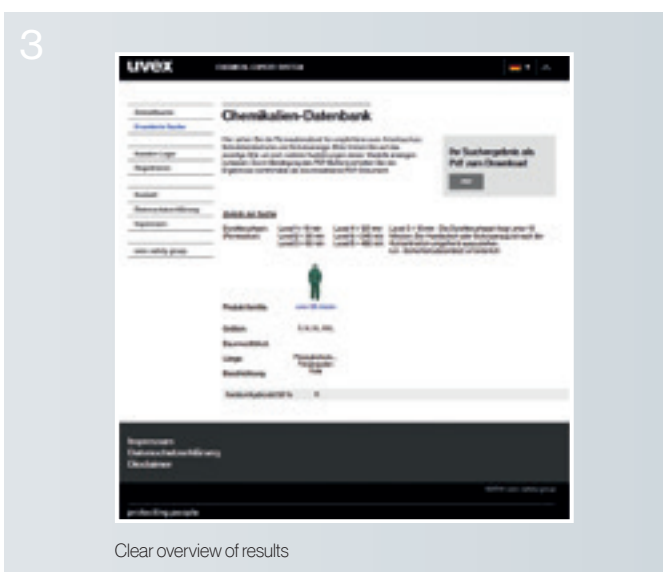

Clear overview of results

Safety Gloves



Innovative safety gloves “Made in Germany”

Manufacturing and technology expertise



Video



uvex centre of expertise for safety gloves in Lüneburg, Germany

Development expertise, state-of-the-art robot-controlled manufacturing technology and stringent quality control ensure the first-class quality of our safety gloves. By manufacturing in Germany, uvex pursues efficient, resource-preserving production processes and ensures that the path from manufacturer to end user is as short as possible.

Development/production

Fully integrated development processes across all stages:

- own yarn/liner manufacturing
- own compounding (blending)
- specially developed moulding and process technology
- innovative coating technology
- development of customer-specific solutions
- technical modifications to existing products (e.g. thermal lining)
- individual production (e.g. gloves for disabled people)

State-of-the-art production:

- 100% solvent-free manufacturing
- sustainable use of resources

Innovation

- Use of high quality natural and functional fibres
 - good skin compatibility
 - high wearer acceptance
- Tested products, free from harmful substances
 - uvex pure Standard (very good skin compatibility, dermatologically tested)
 - Certified in accordance with Oeko-Tex® Standard 100 (e.g. product class II)



MADE IN GERMANY

Detailed information on the award criteria applied by the certification bodies OEKO-TEX®, proDERM and Top100 can be found at: uvex-safety.com/certificates

Extensive know-how is part of our service

Service expertise



We know exactly what you want.

Our expertise is available for you at all times which forms the basis of our on-site. Risk-hazard analysis service: Our hand protection specialists work with you to determine which safety gloves are best suited to your individual requirements. Seminars, laboratory analyses and online tools round off our service portfolio.

Consultation / training / application technology

- on-site consultation from uvex product specialists
- practical hand protection seminars (uvex academy)
- plant and laboratory tours for customers
- cooperation with scientific institutes
- measurement and analysis service in own laboratories
 - mechanical standard test in accordance with EN 388
 - permeation tests in accordance with EN 374
 - special tests (e.g. antistatic/grip measurement/ climate test)
- individual certifications (e.g. for ingredients, coating compatibility, food product suitability)



Information / e-services

- Chemical Expert System (CES)
- designer glove plan
- online product data sheets
- online user instructions
- online declaration of conformity
- online media database

ISO 14001 certification

uvex safety gloves in Lüneburg is the second company within the uvex safety group to have been certified to the international environmental management standard ISO 14001. ISO 14001 focuses on the continuous improvement process, with the aim of enabling concrete environmental goals to be achieved in the long term. No other safety glove manufacturer in Europe has ever achieved this stringent certification before.



For further information, please visit:
www.uvex-safety.de/usglfilm



uvex

uvex i-gonomics

Hand protection with measurably greater relief

uvex i-gonomics redefines wearer comfort: The innovative product system boasts an ergonomic fit, lightweight design and ideal climate characteristics. This makes our safety gloves more comfortable to wear and gives them optimal flexibility – so maximum performance can be achieved at all times, even under extreme conditions.



uvex phynomic airLite A ESD

The safety glove for the fifth sense – with touchscreen compatibility and ESD function.

The uvex phynomic airLite A ESD is the lightest safety glove in its class and offers a noticeable difference in wearer comfort: It combines high sensitivity and tactile feel with lightness and breathability, all in one glove.

This makes it perfect for precision work and handling very small or fine components – and you can still use almost all screens, tablets and mobile phones when you are wearing them.



Scan for more information about the uvex i-gonomics product system.

force 4.8

Test method:
Tensile force/elongation

Test result:
Tensile force at 120% of total elongation = 32 N (IW 4.8)

High flexibility, fatigue-free work

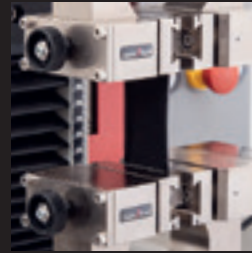

weight 4.3

Test method:
Weight per unit area

Test result:
Weight per unit area = 24.8 mg/cm² (IW 4.3)

High sensitivity and lightness for high wearer acceptance



Relief index calculation:

The relief index is calculated from the average of the three index values (IV) – force, weight and climate – and ranges from 0 (= poor) to 5 (= optimum).



clima 3.1

Test method:
Water vapour permeability

Test result:
R_{ET}-value = 29.21 (IW 3.1)

Reduced perspiration for better wearer acceptance



uvex Chemical Expert System

Chemicals database and glove plans online

As a leader of innovation, we place the highest demands on the products and services. The uvex Chemical Expert System (CES) has been developed by experts for experts. This online tool supports you in the comprehensive analysis and optimisation of safety glove solutions for your business.

Online chemicals database for safety gloves

The uvex Chemical Expert System (CES) offers an extensive chemicals database for selecting the appropriate safety gloves for working with hazardous substances. As a user, you can create a personal permeation list or receive advice from our specialists. It only takes a few clicks to discover the right chemical protection safety gloves for your specific requirements.

Glove plan designer

The glove plan designer in the uvex Chemical Expert System makes it quick and easy to create glove plans to ensure high safety standards in your business. Following completion of the registration process, you can either adapt existing glove plans devised by our specialists or design your own. The system helps you create a complete glove plan in a few simple steps and the high degree of customisation presents a diverse range of possibilities.

uvex Chemical Expert System (online)

Chemicals database for safety gloves

Sort by Hazardous substance ↔ Safety gloves (permeation lists)



Gloves plan designer

Sort by Activity ↔ Safety gloves (glove plans)



Advantages of the uvex Chemical Expert System:

- extensive database of tested chemicals
- individual creation of a permeation list
- easy selection of chemical protection safety gloves
- personal account with premium functions
- self-explanatory creation and management of glove plans
- high degree of glove plan customisation
- available in a variety of languages

uvex – advice and product expertise from a single source.

Website



<https://ces.uvex.de>

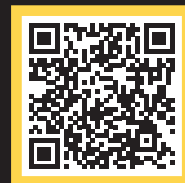

You can find more information at uvex-academy.com

A practical introductory seminar on industrial hand protection

- information on legal and standards requirements concerning the use of safety gloves
- introduction to the relevant chemical substances and how they are classified
- information on the materials used in hand protection and their applications
- information on assessing and avoiding potential dangers in the workplace
- practical demonstration of the protective qualities of different hand protection materials
- guidance in choosing suitable safety gloves at work

Target group

Those responsible for employee health and safety, e.g. health and safety officers, specialist purchasers and representatives of employee groups.

Dates

30 June 2020
19 November 2020

Venue:

UVEX SAFETY Gloves GmbH & Co. KG, Lüneburg



For more information or to book a place, please visit uvex-academy.de, call +49 (0)911 9736 1710 or email academy@uvex.de

EN 388:2016

Modification to the standard for cut protection gloves

Protection classes for cut protection gloves were previously assigned in Europe in accordance with standard EN 388:2003. Due to the continuous development of technical materials – so-called ‘high-performance fibres’ – it has become necessary to adjust the methods used to test and classify these products. These changes have been implemented in standard EN 388:2016.

Test procedure in accordance with EN 388:2003

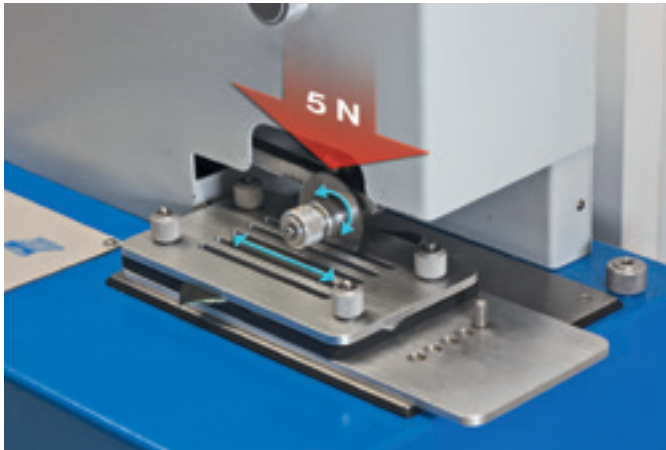

- ▶ Cut resistance test using the coup test
- ▶ Rotating circular knife moves back and forth at a constant force (5 newtons) on the test material and rotates counter to the movement
- ▶ The index value results from the number of cycles required to the point at which the test piece is cut through, and from the degree of wear of the blade.
- ▶ Five measurements are performed in this way on each test piece. The average of the five index values confirms the corresponding performance class for the cut protection level of a safety glove.

| Performance class | 1 | 2 | 3 | 4 | 5 |
|-------------------|-------|-------|-----|------|------|
| Index | ≥ 1,2 | ≥ 2,5 | ≥ 5 | ≥ 10 | ≥ 20 |

Test procedure in accordance with EN 388:2016/ISO 13997

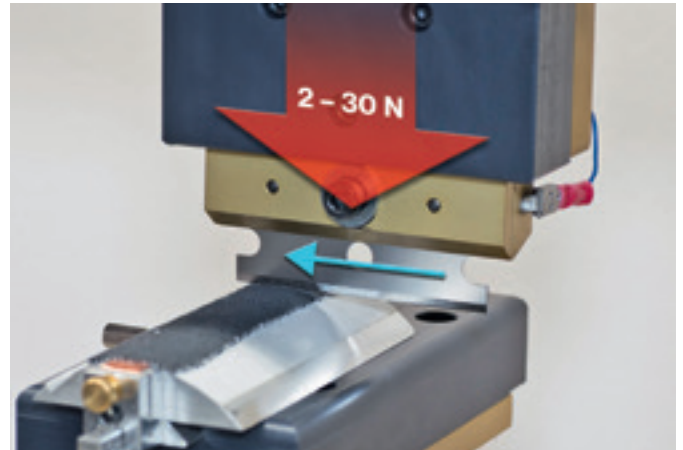

- ▶ Relates to cut protection gloves made from materials that cause the blades to become blunt (i.e. glass and steel fibres).
- ▶ Additional test procedure in accordance with ISO 13997: Determination of resistance of the glove to cutting by a sharp object through single contact under higher force
- ▶ Here, a long, straight blade is drawn once over the test piece. The minimum force required to cut through the test piece after 20 millimetres is determined in the process.
- ▶ The result is given in newtons (N) and assigned to a cut protection class.

| Performance class | A | B | C | D | E | F |
|-------------------|-----|-----|------|------|------|------|
| Newton value | ≥ 2 | ≥ 5 | ≥ 10 | ≥ 15 | ≥ 22 | ≥ 30 |

No correlation can be made between the two test procedures and performance rating. The glove still offers the same high level of cut protection in practice; the only change is to the standard-based classification of its performance.

As a leading manufacturer of cut-protection products, we have state-of-the-art measurement technology for both standards in our own test laboratory, and are therefore available to answer any questions at any time.

For further information regarding the EN 388:2016 and EN ISO 374-1:2016 standards, see:

<https://www.uvex-safety.com/new-standard-cut-protection>

EN 388



4 X 3 2 D

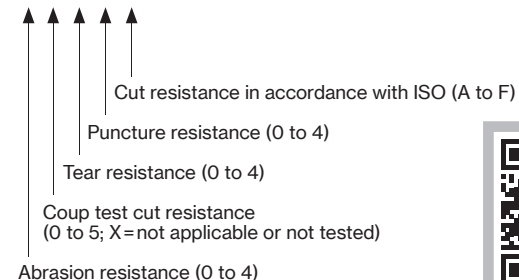

Video



EN ISO 374-1:2016

Modification to the Standard for chemical safety gloves

Chemical safety gloves must meet the requirements of European standard EN ISO 374-1. This standard has undergone fundamental changes in terms of certification.

Part 1 (Terminology and performance requirements for chemical risks) contains important modifications:

- ▶ Expansion of test chemicals from 12 to 18
- ▶ Omission of beaker glass for “water-resistant safety glove with low protection against chemical risks”
- ▶ Standardisation of types of gloves into type A, B or C
- ▶ Modification to labelling on the product:
Pictogram of Erlenmeyer flask with differing number of letters for test chemicals depending on type

New labelling of safety glove:

EN ISO 374-1:2016/Type A



J K L M N O

Permeation resistance of type A:
at least 30 minutes each with at least 6 test chemicals.

EN ISO 374-1:2016/Type B



J K L

Permeation resistance of type B:
at least 30 minutes each with at least 3 test chemicals.

EN ISO 374-1:2016/Type C



Permeation resistance of type C:
at least 10 minutes each with at least 1 test chemical.

As before, the application guidance of the manufacturer is of great importance. The specific protection requirement must be determined as part of a risk assessment of the actual works process taking account of the specific application conditions. A designated safety professional must define the individual requirements and secure conformation of the specific protection levels of the safety gloves from the manufacturer’s data sheets.

Expansion of test chemicals:

The test catalogue has been expanded in accordance with the new standard.

| Letter symbol | Test chemical | CAS no. | Class | |
|---------------|-------------------|------------------------|-----------|-------------------------------------|
| EXPICING | A | Methanol | 67-56-1 | Primary alcohol |
| | B | Acetone | 67-64-1 | Ketone |
| | C | Acetonitrile | 75-05-8 | Nitrile |
| | D | Dichloromethane | 75-09-2 | Chlorinated hydrocarbon |
| | E | Carbon disulphide | 75-15-0 | Sulphur-containing organic compound |
| | F | Toluene | 108-88-3 | Aromatic hydrocarbon |
| | G | Diethylamine | 109-89-7 | Amine |
| | H | Tetrahydrofuran | 109-99-9 | Heterocyclic and ether compounds |
| | I | Ethyl acetate | 141-78-6 | Ester |
| | J | n-heptane | 142-82-5 | Aliphatic hydrocarbon |
| | K | Sodium hydroxide, 40% | 1310-73-2 | Inorganic base |
| | L | Sulphuric acid, 96% | 7664-93-9 | Inorganic acid, oxidising |
| NEW | M | Nitric acid, 65% | 7697-37-2 | Inorganic acid, oxidising |
| | N | Acetic acid, 99% | 64-19-7 | Organic acid |
| | O | Ammonia water, 25% | 1336-21-6 | Organic base |
| | P | Hydrogen peroxide, 30% | 7722-84-1 | Peroxide |
| | S | Hydrofluoric acid, 40% | 7664-39-3 | Inorganic acid |
| T | Formaldehyde, 37% | 50-00-0 | Aldehyde | |

With the uvex Chemical Expert System, uvex provides a multilingual, online platform to search for individual permeation times. In addition, experienced staff are available on-site and in the centre of expertise for safety gloves in Lüneburg to provide advice on all questions relating to safety gloves for protection against chemical risks.



Labelling on the glove

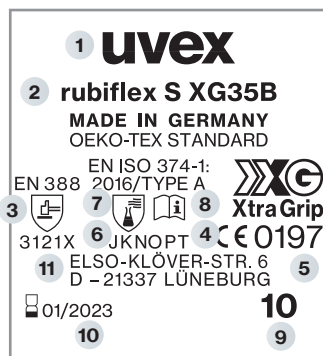

- 1 Name of the manufacturer
- 2 Glove Product Name
- 3 Performance classes, mechanical
- 4 CE conformity mark
- 5 No. of Test Institute
- 6 Letters symbolise test chemicals against which the glove has a protection index of at least class 2.
- 7 Pictogram with designation of standard
- 8 Note enclosed instructions for use
- 9 Glove size
- 10 Expiration date
- 11 Manufacturer address

Permeation

| Time measured to penetration | Protection index |
|------------------------------|------------------|
| > 10 min | Class 1 |
| > 30 min | Class 2 |
| > 60 min | Class 3 |
| > 120 min | Class 4 |
| > 240 min | Class 5 |
| > 480 min | Class 6 |

Permeation refers to molecular penetration through the safety glove material. The time required by the chemicals to permeate, determines the performance class in accordance with EN ISO 374-1. The actual period of protection at the workplace may vary depending on real-time process factors.

Your uvex account manager will be happy to provide advice.

EN 16350:2014

Protective gloves – electrostatic properties

The new standard

Choosing the right personal protective equipment (PPE) is particularly important in working environments that are hazardous or harbour health risks. For workplaces at risk of fire and explosive atmospheres, “EN 16350:2014 – Protective gloves – electrostatic properties” is the first European standard to prescribe the test conditions and minimum requirements for electrostatic properties of safety gloves.

- ▶ vertical resistance must be less than $1.0 \times 10^8 \Omega$ ($R_V < 1.0 \times 10^8 \Omega$).
- ▶ test atmosphere: ambient temperature of $23 \pm 1^\circ\text{C}$, relative humidity of $25 \pm 5\%$.

Important notice:

Electrostatic discharge safety gloves are only effective if the wearer is grounded with resistance of less than $10^8 \Omega$.

What should users take into account?

EN 16350:2014 is the first standard to define a limit value for vertical resistance for protective gloves; this value was not included in DIN EN 1149.

Users must therefore check the suitability of the protective gloves in line with EN 16350:2014.

References to EN 1149 are no longer sufficient, as this standard only describes the testing procedure and does not specify a limit value.

Where can safety gloves certified in accordance with EN 16350:2014 be used?

Safety gloves which have been tested in accordance with EN 16350:2014 can be used in fire and explosive hazard zones, such as refineries. They are an essential part of an uninterrupted grounding chain, which consists of gloves, protective clothing, footwear, the ground and other control measures specified within the workplace. In connection with electrostatic properties, electrostatic discharge (ESD) in the area of product protection is also assessed. Safety gloves tested according to EN 16350:2014 are suited for all ESD product protection applications.



uvex unipur carbon

uvex rubiflex ESD

Suitability grades for safety gloves in the food industry

Safety gloves for working with food must be designed in such a way that absolutely no components can be transferred to food which may pose a hazard to human health (migration) under normal and predictable conditions.

The following overview shows which uvex products are suited for working with food and lists potential areas of application.

Further information including testing specifications is available on request.



| Area of application | Aqueous pH > 4.5 | Acidic pH < 4.5 | Alcoholic | Fatty | Dry, non fatty |
|---|---|-------------------------------------|-----------------------------|---|---|
| Examples | Non-alcoholic beverages Fruit Eggs Vegetables Crustaceans | Vinegar Yeast Milk Yoghurt | Wine Spirits Liqueurs | R1 = olive oil R2 = butter, margarine R3 = fish, cheese, baked goods R4 = meat, poultry R5 = sandwiches, fried food | Bread Pasta Rice Tea Spices Pulses |
| uvex profi ergo | YES | YES | YES | YES (R1 – R5) | YES |
| uvex contact ergo | YES | YES | YES | YES (R1 – R5) | YES |
| uvex phynomic C3 | YES | YES | YES | YES (R1 – R5) | YES |
| uvex phynomic C5 | YES | YES | YES | YES (R1 – R5) | YES |
| uvex rubiflex (orange) | YES | YES | YES | YES (R1 – R5) | YES |
| uvex rubiflex S (blue/green) | YES | YES | YES | YES (R1 – R5) | YES |
| uvex profastrong NF 33 | YES | YES | YES | YES (R2 – R5) | YES |
| uvex u-fit | YES | YES | YES | YES (R3 – R5) | YES |
| uvex phynomic foam | YES | YES | YES | YES (R5) | YES |
| uvex phynomic lite/ uvex phynomic lite w | YES | YES | YES | YES (R1 – R5) | YES |
| uvex unilite thermo | YES | YES | YES | NO | YES |
| uvex u-fit strong N2000 | YES | NO | YES | YES (R3 – R5) | YES |
| uvex u-fit lite | YES | NO | YES | YES (R3 – R5) | YES |
| uvex u-chem 3300 | YES | YES | YES | YES (R2 – R5) | YES |



Safety Gloves

Mechanical Risks

 Precision work 208 – 217, 226



uvex phynomic range



uvex rubipor XS uvex unigrip range uvex synexo M100



uvex unipur range uvex athletic range uvex unilite range

 All-round 218 – 221



uvex contact ergo uvex profi ergo uvex profi XG

 Heavy duty 222, 225



uvex rubiflex uvex compact uvex unilite thermo range

 Heat protection 224



uvex nk uvex k-basic extra uvex profatherm

 Cut protection 227 – 241



uvex phynomic range



uvex D500 foam uvex C500 range uvex C300 range



uvex synexo impact 1 uvex synexo M500 uvex unidur range

Safety Gloves

Chemical Risks

Safety gloves with cotton support

246 – 251

Coating: Nitrile



 Cut protection

Safety gloves without cotton support

252 – 253



Disposable safety gloves

255



The uvex Glove Navigator

The fast way to find the right safety gloves

There are many factors which must be taken into consideration when selecting the appropriate safety gloves. To help you make the right choice, uvex has developed clear guidelines that include helpful symbols for selecting safety gloves for specific areas of application.



1. Identify and classify risk potential

What is the main risk for users in the workplace?
The symbols provide initial guidance to help you choose the right category for the appropriate safety gloves.

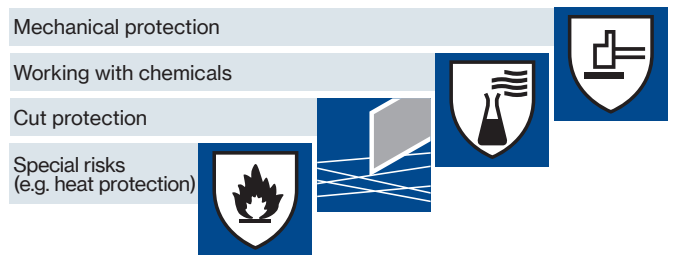

2. Determine individual requirements of the safety gloves

What activities will primarily be carried out at the workplace in question?
Will the nature of the work require precision, entail interchangeable all-round activities or place high demands on the wearer and the safety gloves?

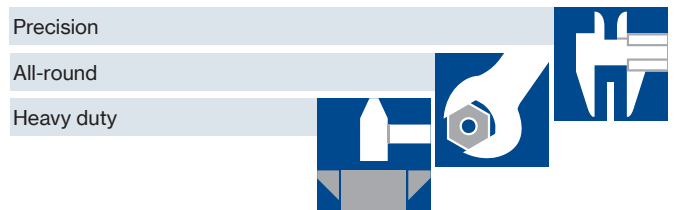

3. Define the application environment

Identify the general conditions of the workplace.
Will activities be carried out in wet/oily, damp or dry working conditions? All of our safety gloves come with one of these 3 environment classification guidelines. The degree of suitability is determined by the aggregate of workplace conditions.





| | | |
|--|---|--|
|  <p>Safety gloves certified according to OEKO-TEX® Standard 100.</p> | <p>MADE IN GERMANY </p> <p>Safety gloves are developed and manufactured in Germany.</p> | <p>pure standard</p> <p>Safety gloves meet the high criteria of the uvex pure standard. Gloves do not contain substances that are hazardous to health, free from solvents and accelerators, and offer optimum product protection.</p> |
| <p>climazone</p> <p>Safety gloves meet the uvex climazone standard. Measurable increased breathability and reduced perspiration for greater wellbeing when wearing safety gloves.</p> |  <p>Gloves demonstrate good skin tolerability during dermatological tests. The glove was clinically tested by the proDERM® Institute for Applied Dermatological Research (Hamburg, Germany) / (proDERM study: 11.0356-02, 11.0482-11, 13.0202-02, 15.0188-02, 15.0219-11).</p> |  <p>Safety glove for use on almost all screens, tablets and mobile phones.</p> |



Detailed information on the award criteria applied by the certification bodies OEKO-TEX®, proDERM and Top100 can be found at: uvex-safety.com/certificates

Mechanical Risks

Area of application: precision/all-round

|  Precision |  All-round |  Heavy duty |
|---|---|--|
| Activities where a high level of sensitivity is necessary. | General, multiple activities for which robust, stable safety gloves are required. | Tough activities requiring highly robust, abrasion resistant safety gloves. |
| Examples: fine assembly work, working with small parts (e.g. screws), operating controls, end inspection. | Examples: servicing, transport work, light metal processing, standard assembly work, maintenance. | Examples: heavy transport work (e. g. palette transport), construction, servicing. |

|  dry |  Precision | | | |  All-round | |  Heavy duty | | | | | | | |
|---|--|--|--|---|---|---|--|---|---|--|--|--|---|---|
|  light moisture / oily |  uvex phynomic airLite A ESD |  uvex phynomic lite/lite w |  uvex unipur range |  uvex rubipor range |  uvex phynomic foam |  uvex phynomic allround |  uvex athletic lite |  uvex synexo M100 |  uvex unilite thermo | | | | | |
|  wet / oily |  uvex phynomic wet | | | |  uvex phynomic XG | |  uvex phynomic pro | |  uvex unilite thermo plus c | | | | | |
|  uvex phynomic wet plus | | | | | | | | | |  uvex contact ergo |  uvex profi ergo |  uvex profi XG |  uvex compact |  uvex unilite thermo HD |

-  Working areas which do not have any moisture (water, oil, fat, cooling lubricant, etc.). Safety gloves for these conditions are extremely breathable.
Examples: quality control, assembly work, distribution, end processing.
-  Working areas with some moisture. Safety gloves for these conditions are less breathable. The water/oil-repelling coating is crucial and also guarantees slip-resistance.
Examples: oil-coated parts, changing between dry and damp working environments.
-  Working areas in which hands should be protected from liquids (not chemicals). Sealed safety gloves with high slip-resistance are necessary.
Examples: removing oily/wet parts from machines, outdoor activities (weather-related humidity).

uvex phynomic

Perfection in 3 dimensions

1. Perfect fit



3D ergo technology – precision all the way to the fingertips

- Ergonomic solution for every wearer: up to 8 perfectly coordinated sizes
- The advantages for the wearer:
- the glove fits like a second skin
- natural touch
- maximum flexibility for fatigue-free work

2. Optimum functionality



Coatings perfectly adapted to the application at hand

- for dry areas: aqua-polymer waterproofing
- for dry and slightly damp areas: aqua-polymer foam coating
- for humid and oily areas: aqua-polymer xtra grip foam coating
- for wet and oily areas: aqua-polymer pro coating
- for applications with industrial touchscreen monitors: airLite aqua-polymer foam coating***

3. Skin safe – product safe



Enhanced skin care and product protection

- Health protection
- no skin irritation
- dermatologically approved*
- certified in accordance with OEKO-TEX® Standard 100
- free from harmful solvents (DMF, TEA)
- free from allergenic substances
- Product protection
- silicone-free according to imprint test
- suitable for sensitive surfaces
- does not leave any traces/marks
- certified for food processes**



* The uvex phynomic series was clinically tested by the proDERM® Institute for Applied Dermatological Research (Hamburg, Germany). The extremely good skin tolerability of uvex phynomic safety gloves has been dermatologically tested (proDERM® studies: 11.0356-02, 11.0482-11, 13.0202-02, 15.0188-02, 15.0219-11). Detailed information on the award criteria applied by the certification bodies OEKO-TEX®, proDERM and Top100 can be found at: uvex-safety.com/certificates

** Models uvex phynomic lite/lite w, uvex phynomic foam, uvex phynomic C3 and phynomic C5

*** Models uvex phynomic airLite A ESD, uvex phynomic airLite B ESD, uvex phynomic airLite C ESD

uvex



Mechanical Risks

Area of application: precision/all-round

An intelligent future

More and more companies are integrating intelligent methods into their production process. The digitalisation of industrial production (Industry 4.0.) is still on its way. You will be equipped for the future with the uvex phynomic airLite A ESD thanks to its touchscreen compatibility for use on almost all screens, tablets and mobile phones.



This applies to all products marked with this symbol.

Health protection and the latest uvex coating technology

The newly developed “airLite” aqua-polymer coating in combination with a high-quality liner (18 gauge) offers not only touchscreen compatibility but also the highest sensitivity and tactile feel for precision work when handling very small or fine components.

It has also been tested by the proDERM® institute in an elaborate user-study process and its skin compatibility has been dermatologically approved.



The uvex phynomic airLite ESD range also offers gloves with cut protection in Cut Level B and C. See page 230 for details.

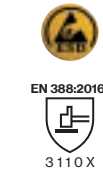

pure standard



MADE IN GERMANY

uvex phynomic airLite A ESD

- the lightest safety glove in its class
- ESD function (DIN EN 16350:2014)
- a noticeable difference in wearer comfort: combination of high sensitivity and tactile feel, lightness and breathability
- touchscreen compatibility for use on almost all screens, tablets and mobile phones
- thin and breathable “airLite” aqua-polymer coating combines the highest sensitivity and tactile feel with touchscreen compatibility
- very good grip in dry and slightly damp areas
- free from accelerators, health protection and skin compatibility dermatologically approved (proDERM®), highly suitable for allergy sufferers

Areas of application:

- precision assembly work
- precision work
- sorting
- quality control



You can find more information at www.uvex-safety.com/airlite

| | |
|--------------------------|---|
| | uvex phynomic airLite A ESD |
| Art. no. | 60038 |
| Design | knitted cuff |
| Standard | EN 388 (3 11 0 X), DIN EN 16350: 2014 |
| Material | polyamide, elastane, carbon |
| Coating | palm and fingertips with airLite aqua-polymer coating |
| Suitable for | for dry and slightly damp areas of application |
| Colour | black |
| Sizes | 6 to 12 |
| Order quantity multiples | 10 PR |



Mechanical Risks

Area of application: precision/all-round

EN 388:2016 3121X

60050

pure standard

OEKO-TEX®
CONFIDENCE IN TEXTILES
STANDARD 100
502-0648 HOHENSTEIN HTTI

Tested for harmful substances.
www.oeko-tex.com/standard100

MADE IN GERMANY

EN 388:2016 3131X

60049

pure standard

OEKO-TEX®
CONFIDENCE IN TEXTILES
STANDARD 100
502-0648 HOHENSTEIN HTTI

Tested for harmful substances.
www.oeko-tex.com/standard100

MADE IN GERMANY

EN 388:2016 4121X

60070

pure standard

OEKO-TEX®
CONFIDENCE IN TEXTILES
STANDARD 100
502-0648 HOHENSTEIN HTTI

Tested for harmful substances.
www.oeko-tex.com/standard100

MADE IN GERMANY

uvex phynomic foam

- dexterity safety glove for precision mechanical work
- very good mechanical abrasion resistance thanks to the damp-resistant aqua-polymer foam coating
- good grip in dry and slightly damp areas
- highly breathable coating
- outstanding tactile feel when assembling parts
- free from accelerators, health protection and skin compatibility dermatologically approved (proDERM®), highly suitable for allergy sufferers

Areas of application:

- precision assembly work
- inspection
- sorting
- food processing
- packaging

uvex phynomic allround

- light and dirt-resistant all-round safety glove for mechanical activities
- very good mechanical abrasion resistance thanks to the damp-resistant aqua-polymer foam coating
- good grip in dry and slightly damp areas
- highly breathable coating
- outstanding tactile feel when assembling parts
- free from accelerators, health protection and skin compatibility dermatologically approved (proDERM®), highly suitable for allergy sufferers

Areas of application:

- maintenance
- assembly
- precision work
- transport/packaging work
- repair work

uvex phynomic XG

- flexible and extremely durable assembly glove with the best oil grip in its class
- outstanding mechanical abrasion resistance thanks to the aqua-polymer Xtra Grip coating
- outstanding grip in oily areas
- high level of breathability with the porous foam coating
- very good tactile feel when assembling (oily) parts
- free from accelerators, health protection and skin compatibility dermatologically approved (proDERM®), highly suitable for allergy sufferers

Areas of application:

- precision work
- assembly
- maintenance
- repair work
- metal processing
- concrete/construction work

| | | | |
|--------------|--|--|--|
| Art. no. | uvex phynomic foam 60050 | uvex phynomic allround 60049 | uvex phynomic XG 60070 |
| Design | knitted cuff | knitted cuff | knitted cuff |
| Standard | EN 388 (3 1 2 1 X) | EN 388 (3 1 3 1 X) | EN 388 (4 1 2 1 X) |
| Material | polyamide, elastane | polyamide, elastane | polyamide, elastane |
| Coating | palm and fingertips with aqua-polymer foam coating | palm and fingertips with aqua-polymer foam coating | aqua-polymer xtra grip foam coating on palm and fingertips |
| Suitable for | dry areas and slightly damp areas | dry areas and slightly damp areas | damp and oily working conditions |
| Colour | white, grey | grey, black | black, black |
| Sizes | 5 to 12 | 5 to 12 | 6 to 12 |
| Order unit | 10 PR | 10 PR | 10 PR |



Mechanical Risks

Area of application: precision/all-round



uvex phynomic wet · uvex phynomic wet plus

- safety glove with water-repellent aqua-polymer foam coating for use in outdoor areas
- outstanding mechanical abrasion resistance thanks to the durable coating
- very good grip in damp and wet areas
- high level of breathability due to the coating
- very good tactile feel when assembling parts
- free from accelerators, health protection and skin compatibility dermatologically approved (proDERM®), highly suitable for allergy sufferers

- Areas of application:
- precision work
 - assembly
 - maintenance
 - repair work

uvex phynomic pro

- high dexterity and dirt- and damp-resistant safety glove
- good mechanical abrasion resistance thanks to the durable aqua-polymer Pro coating
- very good grip in damp, wet and oily areas
- high level of breathability and very good moisture absorption thanks to the natural fibres in the supporting material
- very good tactile feel when handling parts
- outstanding wearer comfort on the skin thanks to the bamboo-polyamide-elastane liner
- free from accelerators, health protection and skin compatibility dermatologically approved (proDERM®), highly suitable for allergy sufferers

- Areas of application:
- assembly
 - maintenance
 - repair work
 - concrete/construction work
 - outdoor activities

| | uvex phynomic wet | uvex phynomic wet plus | uvex phynomic pro |
|---------------------------------|--|---|--|
| Art. no. | 60060 | 60061 | 60062 |
| Design | knitted cuff | knitted cuff | knitted cuff |
| Standard | EN 388 (3131X) | EN 388 (3131X) | EN 388 (2121X) |
| Material | polyamide, elastane | polyamide, elastane | bamboo, polyamide, elastane |
| Coating | aqua-polymer foam coating on palm and fingertips | palm and 3/4 of the back of the hand with aqua-polymer foam coating | palm and 3/4 of the back of the hand with aqua-polymer pro coating |
| Suitable for | damp and oily working conditions | damp and oily working conditions | damp and oily working conditions |
| Colour | blue, anthracite | blue, anthracite | blue, anthracite |
| Sizes | 6 to 12 | 6 to 12 | 6 to 12 |
| Order quantity multiples | 10 PR | 10 PR | 10 PR |



Mechanical Risks

Area of application: precision/all-round/heavy duty

Reduce the risk of injury when handling rotating parts

uvex phynomic x-foam HV

The uvex phynomic x-foam HV is a high-tech innovation in the field of mechanical hand protection. A seamless break section integrated into the base of each finger significantly reduces the tear resistance, allowing the hand to be removed should it become trapped when using manually operated screwdrivers.

The uvex phynomic range offers other advantages too. It stands for perfection in three dimensions: perfect fit, optimal function and absolute purity. The uvex pure standard ensures perfect product and wearer protection.

The glove is free from accelerators, and its health protection and skin compatibility are dermatologically approved (proDERM®).

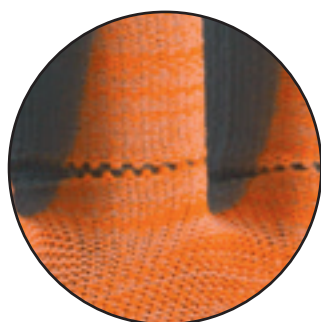

Break section



60054



pure standard



MADE IN GERMANY

uvex phynomic x-foam HV

- unique safety glove with break sections
- reduced tear resistance in the finger area with the integration of a seamless break section, which clearly reduces the risk of severe hand injuries when using hand-held power tools
- very good mechanical abrasion resistance thanks to the damp-resistant aqua-polymer foam coating
- good grip in dry and slightly damp areas
- highly breathable coating
- outstanding tactile feel when assembling parts
- free from accelerators, health protection and skin compatibility dermatologically approved (proDERM®), highly suitable for allergy sufferers



NOTE:

- only partially suitable for handling moving machine parts
- a thorough hazard analysis with the support of our uvex hand protection specialists is vital before use

| | |
|--------------------------|--|
| | uvex phynomic x-foam HV |
| Art. no. | 60054 |
| Design | knitted cuff |
| Standard | EN 388 (3 1 X 1 X) |
| Material | polyamide, elastane |
| Coating | palm and fingertips with aqua-polymer foam coating |
| Suitable for | dry areas and slightly damp areas |
| Colour | orange, grey |
| Sizes | 6 to 12 |
| Order quantity multiples | 10 PR |



Mechanical Risks

Area of application: precision/all-round



60040



60041



pure standard



MADE IN GERMANY

uvex phynomic lite · uvex phynomic lite w

- lightweight safety glove for fatigue-free work
- good mechanical abrasion resistance thanks to the very thin but highly durable aqua-polymer impregnation
- good grip in dry and slightly damp areas
- very high level of breathability with the porous coating, which reduces sweating
- outstanding tactile feel when handling small parts
- free from accelerators, dermatologically approved skin compatibility (proDERM®), highly suitable for allergy sufferers

- Areas of application:
- precision assembly work
 - precision work
 - inspection
 - sorting
 - food processing

| | | |
|---------------------------------|--|--|
| | uvex phynomic lite | uvex phynomic lite w |
| Art. no. | 60040 | 60041 |
| Design | knitted cuff | knitted cuff |
| Standard | EN 388 (2 1 2 1 X) | EN 388 (2 1 2 1 X) |
| Material | polyamide, elastane | polyamide, elastane |
| Coating | palm and fingertips with aqua-polymer impregnation | palm and fingertips with aqua-polymer impregnation |
| Suitable for | dry and slightly damp areas of application | dry and slightly damp areas of application |
| Colour | grey, grey | white, white |
| Sizes | 5 to 12 | 5 to 12 |
| Order quantity multiples | 10 PR | 10 PR |



Mechanical Risks

Area of application: precision/all-round



climazone

MADE IN GERMANY

uvex rubipor XS

- lightweight, elastic safety glove with stretch cotton material
- good grip in dry areas
- very high level of breathability with the thin layer of NBR impregnation
- very good tactile feel through the flexible stretch cotton material with elastane
- ergonomic fit

- Areas of application:
- precision assembly work
 - inspection
 - sorting
 - product protection



| | | |
|--------------------------|--|--|
| Art. no. | uvex rubipor XS2001 60276 | uvex rubipor XS5001B 60316 |
| Design | knitted cuff | knitted cuff |
| Standard | EN 388 (1110 X) | EN 388 (1110 X) |
| Material | cotton interlock, elastane | cotton interlock, elastane |
| Coating | palm and fingertips coated with breathable | palm and fingertips coated with breathable |
| Suitable for | NBR special impregnation dry areas of application | NBR special impregnation dry areas of application |
| Colour | white, white | white, blue |
| Sizes | 6 to 10 | 6 to 10 |
| Order quantity multiples | 10 PR | 10 PR |



Mechanical Risks

Area of application: precision/all-round



uvex athletic lite

- lightweight and sensitive safety glove for mechanical tasks
- matt, porous and particularly abrasion-resistant microfoam coating
- very good grip in dry and slightly damp areas
- high breathability thanks to the porous coating, reducing sweating
- perfect fit thanks to the "slim fit" design and elastane in the liner
- free from hazardous substances in accordance with OEKO-TEX® Standard 100

Areas of application:

- precision assembly work
- maintenance
- inspection
- sorting

uvex athletic allround

- lightweight and dirt-resistant all-round safety glove for mechanical tasks
- very good mechanical abrasion resistance thanks to the damp-resistant aqua-polymer foam coating
- very good grip in dry and slightly damp areas
- perfect fit thanks to the "slim fit" design and elastane with liner
- free from hazardous substances in accordance with OEKO-TEX® Standard 100

Areas of application:

- maintenance
- assembly
- transport/packaging work
- sorting

| | |
|--------------------------|---|
| | uvex athletic lite |
| Art. no. | 60027 |
| Design | knitted cuff |
| Standard | EN 388 (4 1 3 2 X) |
| Material | polyamide, elastane |
| Coating | palm and fingertips with NBR foam coating |
| Suitable for | dry and slightly damp areas |
| Colour | blue, anthracite |
| Sizes | 6 to 11 |
| Order quantity multiples | 10 PR |

| | |
|--------------------------|---|
| | uvex athletic allround |
| Art. no. | 60028 |
| Design | knitted cuff |
| Standard | EN 388 (4 1 2 2 X) |
| Material | polyamide, elastane |
| Coating | palm and fingertips with NBR foam coating |
| Suitable for | dry and slightly damp areas |
| Colour | grey, anthracite |
| Sizes | 6 to 11 |
| Order quantity multiples | 10 PR |



Mechanical Risks

Area of application: precision/all-round



uvex unilite 6605

- lightweight knitted glove with NBR foam coating for mechanical precision work
- good mechanical abrasion resistance with the polyamide liner and coating
- good grip in dry and slightly damp areas
- breathable
- good tactile feel
- good fit
- highly flexible

Areas of application:

- precision assembly work
- fine assembly work
- inspection
- sorting

uvex unilite 7700

- flexible and durable safety glove for mechanical precision work
- good mechanical abrasion resistance with the polyamide-elastane liner and NBR polyurethane coating
- good grip in dry and slightly damp to slightly oily areas
- good tactile feel
- very good fit
- highly flexible

Areas of application:

- precision assembly work
- precision work
- inspection
- sorting

uvex unipur 6634

- moisture-proof NBR safety glove for mechanical applications outdoors
- very good abrasion resistance with the polyamide liner and NBR coating
- good grip in damp areas
- good tactile feel
- good fit
- highly flexible

Areas of application:

- precision assembly work
- precision work
- general repair work
- maintenance



| | |
|--------------------------|--|
| | uvex unilite 6605 |
| Art. no. | 60573 |
| Design | knitted cuff |
| Standard | EN 388 (4 1 2 2 X) |
| Material | polyamide |
| Coating | palm and fingertips coated with nitrile foam coating |
| Suitable for | dry and slightly damp areas |
| Colour | black, black |
| Sizes | 6 to 11 |
| Order quantity multiples | 10 PR |

| | |
|--------------------------|--|
| | uvex unilite 7700 |
| Art. no. | 60585 |
| Design | knitted cuff |
| Standard | EN 388 (4 1 2 1 X) |
| Material | polyamide, elastane |
| Coating | palm and fingertips coated with NBR/polyurethane coating |
| Suitable for | dry and damp, oily working conditions |
| Colour | grey, black |
| Sizes | 7 to 11 |
| Order quantity multiples | 10 PR |

| | |
|--------------------------|---|
| | uvex unipur 6634 |
| Art. no. | 60321 |
| Design | knitted cuff |
| Standard | EN 388 (4 1 3 1 X) |
| Material | polyamide |
| Coating | palm and fingertips coated with NBR coating |
| Suitable for | damp, oily or greasy areas of application |
| Colour | grey, black |
| Sizes | 7 to 10 |
| Order quantity multiples | 10 PR |



Mechanical Risks

Area of application: precision/all-round



60943



60944



60248



uvex unipur 6630 · uvex unipur 6631

- light and very sensitive PU safety glove for mechanical precision work
- good mechanical abrasion resistance
- good grip in dry and slightly damp areas
- outstanding tactile feel
- very good fit
- highly flexible

- Areas of application:
- precision assembly work
 - precision work
 - inspection
 - sorting

uvex unipur 6639

- lightweight, high dexterity and dirt-resistant PU safety glove for mechanical precision work
- good mechanical abrasion resistance
- good grip in dry and slightly damp areas
- outstanding tactile feel
- very good fit
- highly flexible

- Areas of application:
- precision assembly work
 - precision work
 - inspection
 - sorting

| | uvex unipur 6630 | uvex unipur 6631 |
|---------------------------------|--|--|
| Art. no. | 60943 | 60944 |
| Design | knitted cuff | knitted cuff |
| Standard | EN 388 (4 1 4 1 X) | EN 388 (4 1 4 1 X) |
| Material | polyamide | polyamide |
| Coating | palm and fingertips coated with polyurethane coating | palm and fingertips coated with polyurethane coating |
| Suitable for | dry and slightly damp areas | dry and slightly damp areas |
| Colour | white, white | grey, grey |
| Sizes | 6 to 11 | 6 to 11 |
| Order quantity multiples | 10 PR | 10 PR |

| | uvex unipur 6639 |
|---------------------------------|--|
| Art. no. | 60248 |
| Design | knitted cuff |
| Standard | EN 388 (4 1 3 1 X) |
| Material | polyamide |
| Coating | palm and fingertips coated with polyurethane coating |
| Suitable for | dry and slightly damp areas |
| Colour | black, black |
| Sizes | 6 to 11 |
| Order quantity multiples | 10 PR |



Mechanical Risks

Area of application: precision/all-round



Variant with microdots on palm
 60556

EN 388:2016
 2 1 3 1 X
 60587
 Variant without microdots on palm

EN 388:2016
 2 2 4 2 B
 60238

EN 388:2016
 2 2 4 1 B
 60135

MADE IN GERMANY

uvex unipur carbon

- sensitive and anti-static safety glove for precision work with electronic parts
- very good grip
- fulfils requirement of DIN EN 16350:2014
- very high level of breathability
- outstanding tactile feel

- Areas of application:
- working with touchscreens
 - electrical industry
 - work in anti-static areas
 - assembly of electronic components

| | | |
|---------------------------------|--|--|
| | uvex unipur carbon | uvex unipur carbon FT |
| Art. no. | 60556 | 60587 |
| Design | knitted cuff | knitted cuff |
| Standard | EN 388 (2 1 3 1 X) EN 16350:2014 | EN 388 (2 1 3 1 X) EN 16350:2014 |
| Material | polyamide, carbon | polyamide, carbon |
| Coating | palm with carbon microdots, fingertips with thin elastomer coating | fingertips with thin elastomer coating |
| Suitable for | dry areas of application | dry areas of application |
| Colour | grey, black, white | grey, white |
| Sizes | 6 to 10 | 6 to 10 |
| Order quantity multiples | 10 PR | 10 PR |

uvex unigrip

- knitted safety gloves with 13-gauge (uvex unigrip PA and uvex unigrip 6620) for precise mechanical work and 10 gauge (uvex unigrip 6624) for rougher mechanical activities
- good grip with the thin PVC dots in dry areas

- Areas of application:
- assembly
 - sorting
 - packaging

| | | |
|---------------------------------|---------------------------------------|---------------------------------------|
| | uvex unigrip 6624 | uvex unigrip 6620 |
| Art. no. | 60238 | 60135 |
| Design | knitted cuff, 10-gauge | knitted cuff, 13-gauge |
| Standard | EN 388 (2 2 4 2 B) | EN 388 (2 2 4 1 B) |
| Material | polyamide, cotton | polyamide, cotton |
| Coating | palm and fingers coated with PVC dots | palm and fingers coated with PVC dots |
| Suitable for | dry areas of application | dry areas of application |
| Colour | grey, red | white, blue |
| Sizes | 7 to 10 | 7 to 10 |
| Order quantity multiples | 10 PR | 10 PR |



Safety Gloves

Area of application: all-round/heavy duty



Safety gloves for **all-round** use often have to meet numerous criteria. They need to be robust but not too rough and provide excellent grip in both dry and wet/oily conditions.

For **heavy duty** applications, it is particularly beneficial for the safety glove to be highly robust and hard wearing, with excellent grip as well.

Safety Gloves

Area of application: all-round/heavy duty

| | Precision | All-round | Heavy duty |
|---------------------|---|--|--|
| Dry |  <p>uvex phynomic airLite A ESD uvex phynomic lite/lite w uvex unipur range uvex rubipor range</p> |  <p>uvex phynomic foam</p> |  <p>uvex synexo M100 uvex unilite thermo</p> |
| Light moisture/oily | |  <p>uvex phynomic allround uvex athletic lite</p> | |
| | |  <p>uvex phynomic wet uvex phynomic XG</p> |  <p>uvex phynomic pro uvex unilite thermo plus c</p> |
| Wet/oily | |  <p>uvex phynomic wet plus</p> | |
| | |  <p>uvex contact ergo uvex profi ergo</p> |  <p>uvex profi XG uvex compact uvex unilite thermo HD</p> |



Mechanical Risks

Area of application: all-round/heavy duty



EN 388:2016
2121X

60150

EN 388:2016
2121X

60147

EN 388:2016
2121X

60148



MADE IN GERMANY

uvex contact ergo

- thick, hard-wearing cotton interlock safety glove with NBR coating
- very good grip in damp, wet and oily areas
- good tactile feel
- ergonomic fit
- highly flexible
- good wearer comfort with high water vapour absorption of the cotton lining

Areas of application:

- assembly
- inspection
- repair work
- shipping/Logistics
- packaging

uvex profi ergo

- cotton interlock safety glove with NBR coating for universal use
- very good grip in damp, wet and oily areas
- good tactile feel
- ergonomic fit
- high flexibility
- very good wearer comfort due to the high water vapour absorption of the cotton lining

Areas of application:

- assembly
- inspection
- maintenance
- light to medium metal processing

| | |
|---------------------------------|--|
| | uvex contact ergo ENB20C |
| Art. no. | 60150 |
| Design | knitted cuff |
| Standard | EN 388 (2 1 2 1 X) |
| Material | cotton interlock |
| Coating | palm and fingers with special NBR coating (nitrile rubber) |
| Suitable for | oily and greasy areas of application |
| Colour | white, orange |
| Sizes | 6 to 10 |
| Order quantity multiples | 10 PR |

| | | |
|---------------------------------|--|---|
| | uvex profi ergo ENB20A | uvex profi ergo ENB20 |
| Art. no. | 60147 | 60148 |
| Design | knitted cuff | knitted cuff |
| Standard | EN 388 (2 1 2 1 X) | EN 388 (2 1 2 1 X) |
| Material | cotton interlock | cotton interlock |
| Coating | palm and 3/4 of the back of the hand with special NBR coating (nitrile rubber) | palm and whole back of the hand with special NBR coating (nitrile rubber) |
| Suitable for | damp, oily or greasy areas of application | damp, oily or greasy areas of application |
| Colour | white, orange | white, orange |
| Sizes | 6 to 11 | 6 to 10 |
| Order quantity multiples | 10 PR | 10 PR |



Mechanical Risks

Area of application: all-round/heavy duty



XG Xtra Grip



MADE IN GERMANY

uvex profi ergo XG

- safety glove with uvex Xtra Grip Technology
- very good mechanical abrasion resistance thanks to the multi-layer design for increased service life
- outstanding grip in damp, wet and oily areas
- good tactile feel
- ergonomic fit
- highly flexible
- very good wearer comfort with high water vapour absorption of the cotton lining

- Areas of application:
- assembly
 - inspection
 - maintenance
 - light to medium metal processing
 - concrete/construction work
 - outdoor activities



| | uvex profi ergo XG20A | uvex profi ergo XG20 |
|---------------------------------|--|---|
| Art. no. | 60558 | 60208 |
| Design | knitted cuff | knitted cuff |
| Standard | EN 388 (3 1 2 1 X) | EN 388 (3 1 2 1 X) |
| Material | cotton interlock | cotton interlock |
| Coating | palm and 3/4 of the back of the hand with special NBR coating and Xtra Grip coating (nitrile rubber) | palm and whole back of the hand with special NBR and Xtra Grip coating (nitrile rubber) |
| Suitable for | damp, oily or greasy areas of application | damp, oily or greasy areas of application |
| Colour | white, orange, black | white, orange, black |
| Sizes | 6 to 11 | 6 to 11 |
| Order quantity multiples | 10 PR | 10 PR |



Mechanical Risks

Area of application: Heavy duty



89636



MADE IN GERMANY



60946



60945



uvex rubiflex

- fully coated cotton interlock safety glove for mechanical activities
 - very good mechanical abrasion resistance with NBR coating
 - good tactile feel
 - ergonomic fit
- Areas of application:
- inspection
 - maintenance
 - repair work
 - light to medium metal processing
 - varnishing

uvex compact

- very durable NBR safety glove for rough work and manual tasks involving raw materials
 - very good mechanical abrasion resistance with NBR coating
- Areas of application:
- concrete/construction work
 - iron and steel industry
 - wood-working
 - shipping/logistics

| | |
|---------------------------------|--|
| | uvex rubiflex NB27 |
| Art. no. | 89636 |
| Design | gauntlet, approx. 27 cm |
| Standard | EN 388 (3 111 X) |
| Material | cotton interlock |
| Coating | fully coated with special NBR coating (nitrile rubber) |
| Suitable for | damp, oily or greasy areas of application |
| Colour | orange |
| Sizes | 7 to 11 |
| Order quantity multiples | 10 PR |

| | | |
|---------------------------------|--|---|
| | uvex compact NB27E | uvex compact NB27H |
| Art. no. | 60946 | 60945 |
| Design | canvas gauntlet | canvas gauntlet |
| Standard | EN 388 (4 1 2 1 X) | EN 388 (4 1 2 1 X) |
| Material | jersey cotton | jersey cotton |
| Coating | palm and 3/4 of the back of the hand with NBR coating (nitrile rubber) | palm and whole back of the hand with NBR coating (nitrile rubber) |
| Suitable for | damp, oily or greasy areas of application | |
| Colour | white, blue | white, blue |
| Sizes | 9 to 10 | 10 |
| Order quantity multiples | 10 PR | 10 PR |



Mechanical Risks

Area of application: Heavy duty

DIN EN 407:2004 Standard for safety gloves providing protection against thermal risks – heat

The European standard DIN EN 407 regulates the requirements for safety gloves that provide protection against thermal risks in applications involving heat. Safety gloves certified according to this standard protect the wearer against contact heat, radiant heat and small splashes of molten metal, for example.

However, this does not apply to the specific use of safety gloves in firefighting. According to DIN EN 407, heat protection gloves must have the following features:

- low flammability and low flame propagation
- low heat transmission (protection against radiant, convective and contact heat)
- high temperature resistance

EN 407



X 2 X X X X

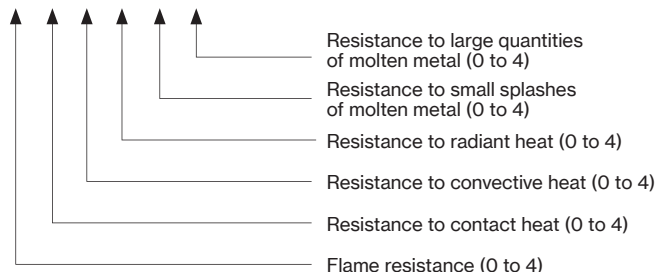

DIN EN 511:2006 Standard for safety gloves providing protection against thermal risks – cold

Cold safety gloves must meet the requirements of the European standard DIN EN 511. The certified gloves below are designed to protect the wearer from penetrating ambient cold and from contact cold through direct contact.

Gloves can also be tested for water impermeability in accordance with EN ISO 15383, thus enabling them to protect the hands from wetness and moisture. This test is considered to have been passed if water does not penetrate the safety glove over a 30-minute period.

EN 511

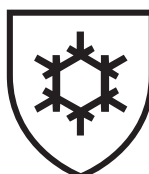

0 1 0

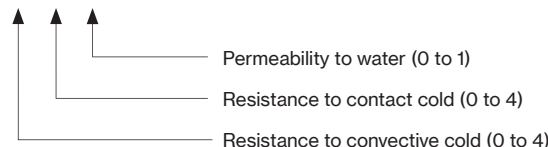

The test described in DIN EN 407 assigns safety gloves a performance class in relation to each of the individual thermal hazards. It is important that the glove does not come into contact with open flames if it does not meet the criteria of performance class 3 in the burning behaviour test.

As with mechanical risk protection, the safety glove is assigned a different performance class for each individual aspect. The performance classes are indicated by a number from 0 to 4 next to the pictogram, whereby 4 is the highest performance class.



Mechanical Risks

Area of application: Heat risks



EN 388:2016 EN 407
2 3 4 2 X X 1 X X X X

60213

Sandwich lining



MADE IN GERMANY



EN 388:2016 EN 407
2 4 4 2 D X 2 X X X X

60179

Cotton cladding

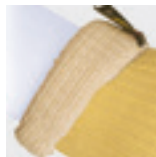

EN 388:2016 EN 407
2 2 4 1 B X 2 X X X X

60595

uvex nk

- safety glove for thermal applications
- good mechanical abrasion resistance
- very good grip in dry, damp and oily areas through the rough surface
- very good thermal insulation in direct contact with warm to hot objects
- suitable for contact heat up to +100 °C (as per EN 407)

Areas of application:

- handling heavy-duty tools
- sheet metal processing
- machinery and tool manufacturing
- handling cold or hot objects

uvex k-basic extra

- Kevlar® coarse-knitted glove for mechanical and thermal activities
- very good thermal insulation in direct contact with warm to hot objects
- suitable for contact heat up to +250 °C
- good cut protection
- good wearer comfort with cotton lining on the inside
- breathable

Areas of application:

- light to medium metal processing
- glass handling
- automotive industry

uvex profatherm

- cotton terry safety glove for thermal applications
- very good thermal insulation in direct contact with warm to hot objects
- suitable for contact heat up to +250 °C
- good wearer comfort with the cotton terry material on the inside

Areas of application:

- light to medium metal processing
- iron/steel industry
- plastics processing industry

| | | |
|---------------------------------|--|----------------------|
| | uvex NK2722 | uvex NK4022 |
| Art. no. | 60213 | 60202 |
| Design | gauntlet, | gauntlet, |
| | approx. 27 cm | approx. 40 cm |
| Standard | EN 388 (2 3 4 2 X), | EN 388 (2 3 4 2 X), |
| | EN 407 (X 1 X X X X) | EN 407 (X 1 X X X X) |
| Material | cotton interlock, aramid knit | |
| Coating | Fully coated with special NBR coating (nitrile rubber) | |
| Suitable for | damp, oily or greasy areas of application | |
| Colour | orange | |
| Sizes | 9 to 10 | 9 to 10 |
| Order quantity multiples | 10 PR | 10 PR |

| | |
|---------------------------------|---------------------------------------|
| | uvex k-basic extra 6658 |
| Art. no. | 60179 |
| Design | knitted cuff, 7-gauge |
| Standard | EN 388 (2 4 4 2 D), |
| | EN 407 (X 2 X X X X) |
| Material | 100 % Kevlar®, cotton lining (inside) |
| Coating | none |
| Suitable for | cut and heat-resistant |
| Colour | yellow |
| Sizes | 8, 10, 12 |
| Order quantity multiples | 6 PR |

| | |
|---------------------------------|----------------------------------|
| | uvex profatherm XB40 |
| Art. no. | 60595 |
| Design | gauntlet, approx. 40 cm |
| Standard | EN 388 (2 2 4 1 B), |
| | EN 407 (X 2 X X X X) |
| Material | cotton terry |
| Coating | none |
| Suitable for | insulation against heat and cold |
| Colour | white |
| Sizes | 11 |
| Order quantity multiples | 6 PR |



Mechanical Risks

Area of application: Heat risks



60593



60592



60942



60591

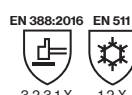
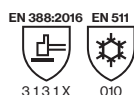
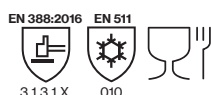

uvex unilite thermo

- winter glove with dual-layer design
- good mechanical abrasion resistance with a polymer coating that is flexible at low temperatures
- very good thermal insulation in direct contact with cold objects
- good fit

- Areas of application:
- work in cold environments
 - concrete/construction work
 - refrigerated warehouse/stores
 - forklift driver

uvex unilite thermo plus cut c

- outstanding tactile feel
- high abrasion resistance
- flexible at cold temperatures
- mechanical resistance
- very high cut protection (Level C)

- Areas of application:
- work in cold environments
 - construction and metalworking industry
 - (refrigerated) warehouses
 - forklift drivers
 - handling sharp parts during: assembly, sorting
 - packaging work



| | uvex unilite thermo | uvex unilite thermo plus | uvex unilite thermo HD |
|---------------------------------|---|---|--|
| Art. no. | 60593 | 60592 | 60942 |
| Design | knitted cuff | knitted cuff | knitted cuff |
| Standard | EN 388 (3131X), EN 511 (010) | EN 388 (3131X), EN 511 (010) | EN 388 (3231X), EN 511 (12X) |
| Material | acrylic and new wool mix (lining), polyamide and elastane (outer) | acrylic and new wool mix (lining), polyamide and elastane (outer) | cotton terry material and acrylic (lining), nylon (outer) |
| Coating | palm and fingertips with cold-flexible polymer coating | palm and 3/4 of the back of the hand with cold-flexible polymer coating | palm and whole back of the hand with PVC coating, 3/4 grip coating |
| Suitable for | dry and slightly damp working conditions | dry and slightly damp working conditions | damp, oily working conditions |
| Colour | black, black | black, black | red, black |
| Sizes | 7 to 11 | 7 to 11 | 8 to 11 |
| Order quantity multiples | 10 PR | 10 PR | 10 PR |

| | uvex unilite thermo plus cut c |
|---------------------------------|---|
| Art. no. | 60591 |
| Design | back of the hand partially coated, knitted cuff |
| Standard | EN 388 (3X42C), EN 511 (02 X) |
| Material | two-layer design: acrylic (inside), glass/polyamide (outside) |
| Coating | palm and fingertips with polymer coating that is flexible in the cold |
| Suitable for | dry and slightly damp working conditions |
| Colour | lime, black |
| Sizes | 7 to 11 |
| Order quantity multiples | 10 PR |



Mechanical Risks

Area of application: Heavy Duty/Construction

The challenges faced in the construction industry are diverse, with tasks ranging from preparatory site works and civil engineering to building installation and interior fitting. To achieve great results, everyone involved must work in flawless synergy with each other – as must all items of personal protective equipment.

uvex has developed and selected over 150 innovative PPE products for the construction industry, all of which are designed to meet the specific needs of the sector. ausgerichtet sind.



All products marked with this symbol are particularly suitable for use in the construction industry. You can find more information on the relevant product pages.



60021



uvex synexo M100

- seamless mechanic's glove with reinforced thumb joints for heavy-duty activities
- good grip in dry and damp areas
- good protection against shocks and impacts thanks to the extra padding in the palm area
- good fit
- highly flexible
- good wearer comfort
- flexible velcro fastening

Areas of application:

- heavy-duty mechanical work
- construction work
- mining
- maintenance

| | |
|--------------------------|---|
| Art. no. | uvex synexo M100 60021 |
| Design | velcro fastening, padding in palm area, knitted cuff |
| Standard | EN 388 (4 1 3 1 X) |
| Material | polyamide |
| Coating | palm and fingertips with NBR coating (nitrile rubber) and Grip finish |
| Suitable for | for dry areas and damp, oily working conditions |
| Colour | red, black |
| Sizes | 7 to 11 |
| Order quantity multiples | 10 PR |



For heavy-duty applications, uvex also offers safety gloves from the HexArmor® brand. More information: www.hexarmor.eu



Mechanical Risks

Areas of application: cut and impact protection

For heavy-duty applications, uvex offers safety gloves from the HexArmor® brand.
More information: www.hexarmor.eu



uvex synexo impact 1

- seamless cut protection glove with protectors and reinforced thumb joints for heavy-duty activities, especially in the oil and gas industry
- very high level of cut protection with HPPE and glass fibre combination
- good grip in dry and damp areas
- good protection against shocks and impacts thanks to the extra padding in the palm area
- protectors on the back of the hand and reinforcements on the finger joints offer additional protection from impact and pinch injuries
- good fit
- high flexibility
- good wearer comfort

Areas of application:

- heavy-duty mechanical work
- mining
- oil and gas industry
- heavy-duty construction work

| | |
|--------------------------|--|
| Art. no. | uvex synexo impact 1 60598 |
| Design | protectors on the back of the hand, velcro fastening, padding in the palm area, knitted cuff |
| Standard | EN 388 (4 X 4 3 C P) |
| Material | HPPE, glass, nylon |
| Coating | palm and fingertips with NBR coating (nitrile rubber) and Grip finish |
| Suitable for | for dry areas and damp, oily working conditions |
| Colour | yellow, black |
| Sizes | 7 to 11 |
| Order quantity multiples | 10 PR |

uvex synexo M500

- seamless mechanic's glove with outstanding cut protection and reinforced thumb joints for heavy-duty activities
- very high level of cut protection with HPPE and glass fibre combination
- good grip in dry and damp areas
- good protection against shocks and impacts thanks to the extra padding in the palm area
- good fit
- high flexibility
- good wearer comfort
- flexible velcro fastening

Areas of application:

- heavy-duty mechanical work
- construction work
- mining
- maintenance

| | |
|--------------------------|---|
| Art. no. | uvex synexo M500 60022 |
| Design | velcro fastening, padding in palm area, knitted cuff |
| Standard | EN 388 (4 X 4 2 C) |
| Material | HPPE, glass, nylon |
| Coating | palm and fingertips with NBR coating (nitrile rubber) and Grip finish |
| Suitable for | for dry areas and damp, oily working conditions |
| Colour | yellow, black |
| Sizes | 7 to 11 |
| Order quantity multiples | 10 PR |



Mechanical Risks

Innovative products for effective protection

Effective hand protection means striking the perfect balance between reliable protection and a comfortable fit – as only safety gloves which are worn can fulfill their purpose. uvex is continuously developing innovative fibre and coating technologies such as the patented Bamboo TwinFlex® technology.

In everyday use, the relationship between cut and tear resistance properties is critical. The required level of cut protection is achieved through a high concentration of glass fibres, the tear resistance could be compromised.

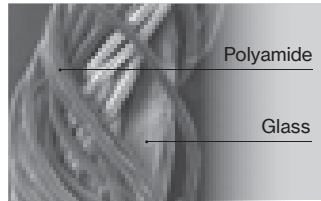

Solid construction. Core – shell – thread.

The techniques used to combine materials such as glass or steel fibres, are key to determining wearer comfort and acceptance. Skin should only come into contact with fibres that are nonirritating and features such as fit and dexterity change yet again when coatings are applied. Equally coatings need to be highly durable to ensure cost effectiveness.

The new classification of cut protection gloves in accordance with EN 388:2016/ISO 13997

The modifications made to the new DIN EN 388:2016/ISO 13997 standard are of particular relevance to cut protection gloves made from materials that cause the blades used to become blunt (e.g. glass and steel fibres).

As a leading manufacturer of cut-protection products, we have invested in state-of-the-art measurement technology for both standards in our test laboratory, and are well placed to address questions on most matters at anytime.

| Differences | EN 388:2003 | EN 388:2016/ISO 13997 |
|----------------------|--------------------------------|------------------------------|
| Blade type | round | straight |
| Cutting method | rotating with repeated contact | straight with single contact |
| Application of force | constant at 5 N | variable between 2 and 30 N |

Classification of cut performance levels

| EN 388:2003 | 1 | 2 | 3 | 4 | 5 |
|-------------|-------|-------|-----|------|------|
| Index | ≥ 1,2 | ≥ 2,5 | ≥ 5 | ≥ 10 | ≥ 20 |

| EN 388:2016/ISO 13997 | A | B | C | D | E | F |
|-----------------------|-----|-----|------|------|------|------|
| Newton value | ≥ 2 | ≥ 5 | ≥ 10 | ≥ 15 | ≥ 22 | ≥ 30 |







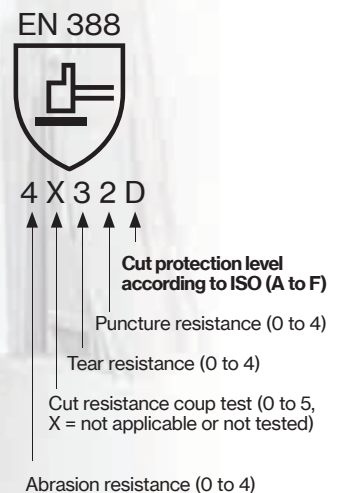



















Labelling of safety gloves

The performance levels are identified in the EN 388:2016/ISO 13997 standard pictogram:



Mechanical Risks

Cut protection at a glance

| ISO Level 13997 | Precision  | All-round  | Heavy duty  | | | | | | | | |
|-----------------|--|---|--|--|---|--|--|---|--|---|---|
| D | |  uvex D500 foam |  uvex unidur 6679 foam |  uvex athletic D5 XP |    | | | | | | |
| | C |  uvex C500 |  uvex C500 dry |  uvex C300 dry |  uvex phynomic airLite C ESD |  uvex phynomic C5 |  uvex C300 foam |  uvex C500 foam |  uvex unidur 6659 foam |  uvex C500 M foam |    |
| | | | | |  uvex C300 wet |  uvex synexo M500 |  uvex C500 wet |  uvex C500 wet plus |  uvex C500 XG |  uvex synexo impact 1 |   |
| | | | | | | | | | | |    |
| B |  uvex phynomic airLite B ESD |  uvex phynomic C3 |  uvex unidur 6641 |  uvex unidur 6648 |  uvex unidur 6649 |  uvex unidur 6643 | | | |    | |



For safety gloves with cut protection level E and above, uvex recommends products from HexArmor®.

Mechanical Risks

Area of application: cut protection



uvex phynomic airLite B ESD

- the lightest and most sensitive cut protection glove in Cut Level B
 - ESD function (DIN EN 16350:2014)
 - noticeable difference in wearer comfort: combination of the highest sensitivity, lightness and high breathability
 - touchscreen compatibility for use on almost all screens, tablets and mobile phones
 - thin, breathable "airLite" aqua-polymer coating in combination with a high-quality liner (18 gauge) offers the highest sensitivity and tactile feel for precision work
 - very good grip in dry and slightly damp areas
 - free from glass and steel fibres
 - free from accelerators, dermatologically approved skin compatibility (proDERM®), highly suitable for allergy sufferers
- Areas of application:
- precision assembly work
 - precision work
 - inspection
 - sorting
 - food processing

| | |
|---------------------------------|--|
| | uvex phynomic airLite B ESD |
| Art. no. | 60078 |
| Design | knitted cuff |
| Standard | EN 388 (3 X 3 2 B), DIN EN 16350: 2014 |
| Material | Dyneema® Diamond Technology, polyamide, elastane, carbon |
| Coating | aqua-polymer coating airLite on palm and fingertips |
| Suitable for | dry areas and slightly damp areas |
| Colour | sky blue, black |
| Sizes | 6 to 12 |
| Order quantity multiples | 10 PR |

uvex phynomic airLite C ESD

- the lightest and most sensitive cut protection glove in Cut Level C
 - ESD function (DIN EN 16350:2014)
 - noticeably thin and sensitive in combination with high cut protection (Level C) thanks to innovative cut protection fibres: Dyneema® Diamond 2.0
 - free from glass and steel fibres
 - touchscreen compatibility for use on almost all screens, tablets and mobile phones
 - thin, breathable "airLite" aqua-polymer coating in combination with a high-quality liner (18 gauge) offers the highest sensitivity and tactile feel for precision work
 - very good grip in dry and slightly damp areas
 - accelerators, health protection and skin compatibility dermatologically approved (proDERM®), highly suitable for allergy sufferers
- Areas of application:
- precision assembly work
 - precision work
 - inspection
 - sorting
 - food processing

| | |
|---------------------------------|--|
| | uvex phynomic airLite C ESD |
| Art. no. | 60084 |
| Design | knitted cuff |
| Standard | EN 388 (3 X 4 2 C), DIN EN 16350: 2014 |
| Material | Dyneema® Diamond 2.0 Technology, polyamide, elastane, carbon |
| Coating | palm and fingertips with aqua-polymer coating airLite |
| Suitable for | dry areas and slightly damp areas |
| Colour | blue, black |
| Sizes | 6 to 12 |
| Order quantity multiples | 10 PR |



Mechanical Risks

Area of application: cut protection



uvex phynomic C3

- sensitive cut protection safety glove for mechanical activities
- suitable for use in the food industry
- very good mechanical abrasion resistance thanks to the damp-resistant aqua-polymer foam coating
- good grip in dry and slightly damp areas
- good cut protection and high tear resistance
- highly breathable coating
- outstanding tactile feel when assembling parts
- free from accelerators, health protection and skin compatibility dermatologically approved (proDERM®), highly suitable for allergy sufferers

Areas of application:

- assembly
- inspection
- sorting
- food processing

| | |
|--------------------------|--|
| Art. no. | uvex phynomic C3 60080 |
| Design | knitted cuff |
| Standard | EN 388 (4 X 4 3 B) |
| Material | polyamide, elastane, HPPE, glass |
| Coating | aqua-polymer foam coating on palm and fingertips |
| Suitable for | dry areas and slightly damp areas |
| Colour | sky blue, grey |
| Sizes | 6 to 12 |
| Order quantity multiples | 10 PR |

uvex phynomic C5

- all-round cut protection safety glove for mechanical activities
- suitable for use in the food industry
- very good mechanical abrasion resistance thanks to the moisture-resistant aqua-polymer foam coating
- very good grip in dry and slightly damp areas
- very good cut protection (level C) and high tear resistance
- highly breathable coating
- outstanding tactile feel when assembling parts
- free from accelerators, health protection and skin compatibility dermatologically approved (proDERM®), highly suitable for allergy sufferers

Areas of application:

- assembly
- inspection
- sorting
- food processing

| | |
|--------------------------|--|
| Art. no. | uvex phynomic C5 60081 |
| Design | knitted cuff |
| Standard | EN 388 (4 X 4 2 C) |
| Material | Dyneema® Diamond Technology, polyamide, elastane |
| Coating | palm and fingertips with aqua-polymer foam coating |
| Suitable for | dry areas and slightly damp areas |
| Colour | blue, grey |
| Sizes | 6 to 12 |
| Order quantity multiples | 10 PR |



The comfort class in cut protection

The latest generation of Bamboo TwinFlex® technology

uvex cut protection gloves based on the latest generation of patented uvex Bamboo TwinFlex® technology set new standards in protection, comfort, flexibility, dexterity and economy. The comfort class in robust cut protection helps increase wearer acceptance – particularly when carrying out demanding activities. The unique combination of natural

bamboo and high-tech protective fibres ensures a high level of wearer comfort and good climate control while also providing effective protection. After all, a safety glove can only help to prevent accidents if the user actually wears it.

Cut protection level C and D

Bamboo TwinFlex® technology – high-tech for added comfort

- robust and comfortable
- bamboo – environmentally friendly, renewable raw material
- cooling effect
- regular fit

Patented Bamboo TwinFlex® protection

Cut-resistant glass fibres and abrasion-resistant polyamide guarantee optimum mechanical protection. The use of steel fibres in combination with polyamide increases the cut protection to as high as level D.

Patented Bamboo TwinFlex® comfort

Soft, comfortable bamboo yarn for a soft feel and perfect climate control combined with resistant HPPE fibres for high tear resistance. The combination of bamboo yarn with innovative DSM Dyneema® diamond fibres provides a further significant boost to tear and cut resistance.

| Bamboo TwinFlex® Technology ¹ | | | |
|---|--|---|---|
| Cut protection level C | | Cut protection level D | |
| Double Face Principle | | | |
| | | | |
| Polyamide (abrasion resistance) | Bamboo (wearer comfort) | Polyamide (abrasion resistance) | Bamboo (wearer comfort) |
| | | | |
| Glass fibres (cut protection) | High-grade HPPE fibres (tear resistance) | Steel fibres (cut protection) | DSM Dyneema® Diamond fibre² (cut resistance/tear resistance) |
| e.g. uvex C500 M, uvex C500 und uvex C300 | | e.g. uvex D500 foam | |



Website



uvex D500 foam

Uncompromisingly robust without loss of comfort



First-class climate control

uvex climazone – measurably enhanced comfort

- reduced sweating
- high breathability
- significantly greater moisture absorption compared to other yarns

Wearer comfort and an improved microclimate are the ultimate benchmarks in safety gloves. This is why the uvex climazone glove climate control system is being continuously developed together with market-leading partners and renowned testing and research institutes, such as the Hohenstein Institute and the Pirmasens Institute (PFI). Individual measurement facilities, such as the PFI's Climatester, provide a specific insight into thermo-physiological and skin-sensory wearer comfort.



climazone

Mechanical Risks

Area of application: cut protection



Crouch zone reinforcement ▶



uvex D500 foam

- excellent dexterity
- high abrasion resistance thanks to the innovative Soft-Grip-Coating
- very good grip in slightly damp environments
- very high uvex cut protection with Bamboo Twin Flex® Technology
- high flexibility
- very good tactile feel
- perfect fit with 3D Ergo man mold technology

- Areas of application:
- automotive industry
 - construction
 - brewery, beverage industry
 - glass industry
 - maintenance, servicing
 - metal work industry

| | |
|--------------------------|---|
| | uvex D500 foam |
| Art. no. | 60604 |
| Design | knitted cuff |
| Standard | EN 388 (4 X 4 2 D) |
| Material | bamboo-rayon, Dyneema® Diamond, steel, polyamide |
| Coating | palm and fingertips with high-performance elastomer (HPE) and SoftGrip foam coating |
| Suitable for | dry areas and slightly damp areas |
| Colour | lime, anthracite |
| Sizes | 7 to 11 |
| Order quantity multiples | 10 PR |

uvex C500 M foam

- cut protection safety gloves with outstanding wearer comfort
- outstanding mechanical abrasion resistance thanks to the innovative SoftGrip coating
- very good grip in dry and slightly damp environments
- very high level of cut protection with patented Bamboo TwinFlex® technology
- suitable for contact heat up to +100 °C, in line with EN 407
- partially reinforced thumb joints
- high flexibility
- very good tactile feel
- perfect fit with 3D Ergo man mould technology
- silicone-free according to imprint test

- Areas of application:
- automotive industry
 - construction
 - breweries and beverage production
 - glass industry
 - maintenance
 - metalworking industry

| | |
|--------------------------|---|
| | uvex C500 M foam |
| Art. no. | 60498 |
| Design | crouch zone reinforcement, knitted cuff |
| Standard | EN 388 (4 X 4 2 C), EN 407 (X 1 X X X X) |
| Material | bamboo-rayon, HPPE, glass, polyamide |
| Coating | High Performance Elastomer (HPE), SoftGrip foam |
| Suitable for | for dry and slightly oily/damp areas |
| Colour | lime, black, anthracite |
| Sizes | 7 to 11 |
| Order quantity multiples | 10 PR |



Mechanical Risks

Area of application: cut protection



uvex C500

- cut protection safety gloves and underarm protection (uvex C500 sleeve) with outstanding wearer comfort
- outstanding mechanical abrasion resistance thanks to the innovative Soft Grip coating
- very good grip in dry (all models) and slightly damp (uvex C500 foam and C500 pure) environments
- very high level of cut protection with patented uvex Bamboo TwinFlex® technology models suitable for contact heat up to +100°C, in line with EN 407 (uvex C500 foam and C500 wet)
- highly flexible
- very good tactile feel
- perfect fit with 3D Ergo technology
- silicone-free according to imprint test

- Areas of application:
- automotive industry
 - assembly
 - maintenance
 - metalworking
 - shipping/logistics
 - sorting
 - glass handling
 - sheet metal processing
 - paper industry
 - building and construction industry
 - iron/steel industry



| Art. no. | uvex C500 sleeve | uvex C500 | uvex C500 wet plus | uvex C500 XG |
|---------------------------------|---|--------------------------------------|--|---|
| 60491-07 | 60491-10 | 60497 | 60496 | 60600 |
| Design | underarm protection with velcro fastening, 34 cm (M), 40 cm (L) | knitted cuff | knitted cuff | knitted cuff |
| Standard | EN 388 (2 X 4 X C) | EN 388 (1 X 4 X C) | EN 388 (4 X 4 2 C) | EN 388 (4 X 4 2 C) |
| Material | bamboo rayon, HPPE, glass, polyamide | bamboo rayon, HPPE, glass, polyamide | bamboo rayon, HPPE, glass, polyamide | bamboo rayon, HPPE, glass, polyamide |
| Coating | none | none | palm and 3/4 of the back of the hand with high performance elastomer (HPE) coating | palm and whole back of the hand with high performance elastomer (HPE) and Xtra Grip coating |
| Suitable for | dry areas of application | dry areas of application | damp, oily or greasy areas of application | damp, wet, oily or greasy areas of application |
| Colour | lime | lime | lime, anthracite | lime, anthracite |
| Sizes | M L | 7 to 11 | 7 to 11 | 7 to 11 |
| Order quantity multiples | PC | PC | 10 PR | 10 PR |
| Order unit | | | | |



Mechanical Risks

Area of application: cut protection



climazone
MADE IN GERMANY

uvex C500

- cut protection safety gloves with outstanding wearer comfort
- outstanding mechanical abrasion resistance thanks to the innovative SoftGrip coating (uvex C500 foam and uvex C500 wet)
- very good grip in dry (all models), slightly damp (uvex C500 foam) and wet (uvex C500 wet) environments
- very high level of cut protection with patented uvex Bamboo TwinFlex® technology

- in line with EN 407, the model is suitable for contact heat up to +100°C (uvex C500 foam and C500 sleeve)
- highly flexible
- very good tactile feel
- perfect fit with 3D Ergo technology
- silicone-free according to imprint test

- Areas of application:
- automotive industry
 - assembly
 - maintenance
 - metalworking
 - shipping/logistics
 - sorting
 - glass handling
 - sheet metal processing
 - paper industry
 - building and construction industry
 - iron/steel industry

| | uvex C500 dry | uvex C500 foam | uvex C500 wet |
|---------------------------------|--|--|---|
| Art. no. | 60499 | 60494 | 60492 |
| Design | knitted cuff | knitted cuff | knitted cuff |
| Standard | EN 388 (X X 4 X C) | EN 388 (4 X 4 2 C), EN 407 (X 1 X X X X) | EN 388 (4 X 4 2 C), EN 407 (X 1 X X X X) |
| Material | bamboo rayon, HPPE, glass, polyamide | bamboo rayon, HPPE, glass, polyamide | bamboo rayon, HPPE, glass, polyamide |
| Coating | palm and fingers with high performance vinyl (HPV) grip dots | palm and fingertips with high performance elastomer (HPE) and Soft Grip foam coating | palm and fingertips with high performance elastomer (HPE) coating |
| Suitable for | dry areas of application | dry areas of application | damp, oily or greasy areas of application |
| Colour | lime, anthracite | lime, anthracite | lime, anthracite |
| Sizes | 7 to 11 | 7 to 11 | 7 to 11 |
| Order quantity multiples | 10 PR | 10 PR | 10 PR |



Mechanical Risks

Area of application: cut protection



climazone
MADE IN GERMANY

uvex C300

- cut protection glove with excellent wearer comfort
- outstanding mechanical abrasion resistance thanks to the innovative SoftGrip coating (uvex C300 foam and uvex C300 wet)
- very good grip in dry (all models), slightly damp (uvex C300 foam) and wet (uvex C300 wet) environments

- good cut protection with patented uvex Bamboo TwinFlex® technology
- highly flexible
- very good tactile feel
- perfect fit with 3D Ergo technology
- silicone-free according to imprint test

- Areas of application:
- automotive industry
- assembly
- maintenance
- metalworking
- shipping/logistics
- sorting
- glass handling
- sheet metal processing



| | uvex C300 dry | uvex C300 foam | uvex C300 wet |
|---------------------------------|--|--|---|
| Art. no. | 60549 | 60544 | 60542 |
| Design | knitted cuff | knitted cuff | knitted cuff |
| Standard | EN 388 (X X 4 X C) | EN 388 (3 X 4 2 C) | EN 388 (4 X 4 2 C) |
| Material | bamboo rayon, HPPE, glass, polyamide | bamboo rayon, HPPE, glass, polyamide | bamboo rayon, HPPE, glass, polyamide |
| Coating | palm and fingers with high performance vinyl (HPV) grip dots | palm and fingertips with high performance elastomer (HPE) and Soft Grip foam coating | palm and fingertips with high performance elastomer (HPE) coating |
| Suitable for | dry areas of application | dry areas of application | damp, oily or greasy areas of application |
| Colour | anthracite | anthracite | anthracite |
| Sizes | 7 to 11 | 7 to 11 | 7 to 11 |
| Order quantity multiples | 10 PR | 10 PR | 10 PR |



Mechanical Risks

Area of application: cut protection



uvex unidur 6641

- PU cut protection safety glove with high-quality Special Cut Performance PE fibre
- outstanding mechanical abrasion resistance thanks to a good combination of fibres and coating
- good grip in dry and slightly damp areas
- good cut protection due to high-quality Special Cut Performance PE fibre
- very good tactile feel
- highly flexible
- outstanding comfort

Areas of application:

- automotive industry
- maintenance
- assembly
- metalworking
- packaging

| | |
|---------------------------------|---|
| | uvex unidur 6641 |
| Art. no. | 60210 |
| Design | knitted cuff |
| Standard | EN 388 (4 3 4 3 B) |
| Material | HPPE, elastane |
| Coating | palm and fingertips with polyurethane coating |
| Suitable for | dry areas and slightly damp areas |
| Colour | white, grey |
| Sizes | 6 to 11 |
| Order quantity multiples | 10 PR |

uvex unidur 6643

- NBR cut protection safety glove with high-quality Special Cut Performance PE fibre
- outstanding mechanical abrasion resistance with NBR coating
- good grip in damp and oily areas
- good cut protection due to high-quality Special Cut Performance PE fibre
- good tactile feel
- highly flexible
- good wearer comfort

Areas of application:

- automotive industry
- maintenance
- assembly
- sheet metal processing
- repair work

| | |
|---------------------------------|---|
| | uvex unidur 6643 |
| Art. no. | 60314 |
| Design | knitted cuff |
| Standard | EN 388 (4 3 4 4 B) |
| Material | HPPE, polyamide, elastane |
| Coating | palm and fingertips with NBR coating (nitrile rubber) |
| Suitable for | damp, oily or greasy areas of application |
| Colour | mottled grey, black |
| Sizes | 7 to 10 |
| Order quantity multiples | 10 PR |



Mechanical Risks

Area of application: cut protection



EN 388:2003 EN 388:2016

 4 3 4 2 4 3 4 2 B

60932



EN 388:2003 EN 388:2016

 4 3 4 2 4 3 4 2 B

60516

uvex unidur 6648

- PU cut protection glove with HPPE fibres
- outstanding mechanical abrasion resistance
- good grip in damp and oily areas
- good cut protection with HPPE fibres
- good tactile feel
- highly flexible
- good wearer comfort

Areas of application:

- automotive industry
- repair work
- light to medium metal processing
- packaging

uvex unidur 6649

- PU cut protection glove with HPPE fibres
- outstanding mechanical abrasion resistance
- good grip in damp and oily areas
- good cut protection with HPPE fibres
- good tactile feel
- highly flexible
- good wearer comfort

Areas of application:

- automotive industry
- repair work
- light to medium metal processing
- packaging



| | |
|---------------------------------|---|
| | uvex unidur 6648 |
| Art. no. | 60932 |
| Design | knitted cuff |
| Standard | EN 388 (4 3 4 2 B) |
| Material | HPPE, elastane |
| Coating | palm and fingertips with polyurethane coating |
| Suitable for | dry areas and slightly damp areas |
| Colour | white, black |
| Sizes | 6 to 11 |
| Order quantity multiples | 10 PR |

| | |
|---------------------------------|---|
| | uvex unidur 6649 |
| Art. no. | 60516 |
| Design | knitted cuff |
| Standard | EN 388 (4 3 4 2 B) |
| Material | HPPE, polyamide, elastane |
| Coating | palm and fingertips with polyurethane coating |
| Suitable for | dry areas and slightly damp areas |
| Colour | mottled blue, grey |
| Sizes | 7 to 11 |
| Order quantity multiples | 10 PR |



Mechanical Risks

Area of application: cut protection



uvex unidur 6659 foam

- cut protection glove with NBR foam coating and HPPE/glass fibre
- outstanding mechanical abrasion resistance with NBR coating
- good grip in dry and slightly damp areas
- high level of cut protection with HPPE and glass fibre combination
- very good tactile feel
- highly flexible
- outstanding comfort

Areas of application:

- automotive industry
- assembly
- maintenance
- metalworking
- shipping/logistics

| | |
|---------------------------------|---|
| | uvex unidur 6659 foam |
| Art. no. | 60938 |
| Design | knitted cuff |
| Standard | EN 388 (4 X 4 3 C) |
| Material | HPPE, glass, polyamide |
| Coating | palm and fingertips with nitrile foam coating |
| Suitable for | dry areas and slightly damp areas |
| Colour | mottled grey, black |
| Sizes | 6 to 11 |
| Order quantity multiples | 10 PR |

uvex unidur 6679 foam

- cut protection safety glove with NBR foam coating and HPPE/steel fibres
- highly durable NBR foam coating for outstanding mechanical resistance and increased product life
- good grip in dry and slightly damp areas
- very good cut protection (level D) thanks to HPPE/steel fibre combination
- very good tactile feel
- high flexibility
- very good wearer comfort

Areas of application:

- automotive industry
- metal industry
- packaging

| | |
|---------------------------------|---|
| | uvex unidur 6679 foam |
| Art. no. | 60969 |
| Design | knitted cuff |
| Standard | EN 388 (4 X 4 4 D) |
| Material | HPPE, steel, nylon, elastane |
| Coating | palm and fingertips with nitrile foam coating |
| Suitable for | dry areas and slightly damp areas |
| Colour | grey, black |
| Sizes | 6 to 11 |
| Order quantity multiples | 10 PR |

uvex athletic D5 XP

- very high cut protection (Level D)
- good grip on dry and (slightly)
- oily/wet workpieces
- very good mechanical abrasion resistance
- reinforced thumb joints
- high flexibility, very good fit
- very good tactile feel
- suitable for industrial washing

Areas of application:

- automotive industry
- metalworking industry
- glass industry
- inspection
- sorting
- packaging

| | |
|---------------------------------|--|
| | uvex athletic D5 XP |
| Art. no. | 60030 |
| Design | knitted cuff |
| Standard | EN 388 (4 X 4 3 D) |
| Material | HPPE, steel, polyamide, elastane |
| Coating | palm and fingertips coated, micro NBR foam coating |
| Suitable for | dry and slightly damp/oily working conditions |
| Colour | grey, anthracite |
| Sizes | 6 to 11 |
| Order quantity multiples | 10 PR |



Mechanical Risks

Area of application: cut protection



EN 388:2016

 2 X 4 X C

60973



EN 388:2016

 2 X 4 X C

60974



uvex unidur sleeve C

- very high cut protection (Cut Level C)
- very thin and flexible
- high comfort
- velcro fastening for a custom fit
- OEKO-TEX® Standard 100

Areas of application:

- automotive industry
- glass industry
- metalworking industry
- assembly
- maintenance
- construction work

uvex unidur sleeve C TL

- very high cut protection (Cut Level C)
- very thin and flexible
- high comfort
- velcro fastening for a custom fit
- OEKO-TEX® Standard 100
- thumb loop (TL) for added safety (protection against cuts on the wrist)

Areas of application:

- automotive industry
- glass industry
- metalworking industry
- assembly
- maintenance
- construction work



| | |
|---------------------|--|
| | uvex unidur sleeve C |
| Art. no. | 60973 |
| Design | Lower arm protection with velcro fastening 46 cm (size M), 50 cm (size L) |
| Standard | EN 388 (4 X 4 X C) |
| Material | HPPE, glass, polyamide |
| Coating | without coating |
| Suitable for | for dry areas |
| Colour | mottled grey |
| Sizes | M, L |
| Order unit | PC |

| | |
|---------------------|--|
| | uvex unidur sleeve C TL |
| Art. no. | 60974 |
| Design | Lower arm protection with velcro fastening with thumb loop 46 cm (size M), 50 cm (size L) |
| Standard | EN 388 (2 X 4 X C) |
| Material | HPPE, glass, polyamide |
| Coating | without coating |
| Suitable for | for dry areas |
| Colour | mottled grey |
| Sizes | M, L |
| Order unit | PC |



Chemical Risks

Selecting the right hand protection

Selecting the right safety gloves is absolutely essential when working with chemicals. Chemical protection safety gloves protect wearers from possible hazards that can cause permanent damage or even death.

As an active partner, uvex offers suitable product solutions and competent expert advice, including on-site visits. uvex's application technicians in Lüneburg (Germany) are on hand to contribute their expertise in order to co-develop the perfect solutions for any environment. In addition, uvex's test laboratory can create customer-specific permeation lists that are in accordance with the requirements of respective norms.



We would be glad to provide you with individual advice on workplace analysis and resistance lists.

Chemical Risks

Selecting the right hand protection

Chemical Expert System: uvex online chemicals database

The choice and product life of chemical protection safety gloves is essentially determined by the resistance of the glove material to the chemicals being used.

As a manufacturer, uvex's comprehensive online chemicals database offers quick and clear support. Just a few steps is all it takes to find information on the resistance of uvex safety gloves when working with particular chemicals.

Benefits at a glance:

- online database is always available (24/7)
- easy to use in many different languages
- registered users have full access to test results for all listed chemicals
- personal account with premium functions
- individual creation of permeation lists and glove plans

Website



1

Entry page to chemicals database

2

Variety of different search options



3

Clear overview of results

4

Option to save search results

Chemical Risks

Selecting the right hand protection

Alongside the right protective function, wearer comfort is extremely important in safety gloves.

Chemical protection safety gloves must be used in a wide variety of areas of application while still enabling wearers to complete tasks effectively.

With this in mind, uvex pays particular attention to the demands that will be placed on products in particular areas of application when it develops new chemical protection safety gloves.

The matrix provides guidance to assist in the selection of the right chemical glove for your workplace risks.

| |  Precision |  All round |  Heavy duty |
|--|--|---|---|
| Protective gloves with textil support for outstanding wearer comfort | | | |
| NBR |  uvex u-chem 3300 |  uvex rubiflex S (blue) |  ESD ▶ uvex rubiflex ESD |
| | |  Grip ▶ |  Grip ▶ |
| | | |  |
| | | |  seamless ▶ |
| | | |  |
| Protective gloves without textil support, some with lightly flocked finish | | | |
| NBR | |  flocked ▶ uvex profastrong | |
| Chloroprene | |  flocked ▶ uvex profapren | |
| Special materials | |  |  |
| Disposable protective gloves for short-term use | | | |
| NBR |  uvex u-fit lite |  uvex u-fit |  reinforced ▶ uvex u-fit strong N2000 |

Chemical Risks

Product solutions “Made in Germany”



uvex rubiflex (blue)

- the lightest and most flexible chemical protection safety gloves
- ergonomic fit: instant comfort guaranteed
- exceptional sensitivity
- extremely comfortable cotton interlock lining for high moisture absorption (reduced perspiration when compared with synthetic fibres such as acrylic and polyester)

Further development



uvex rubiflex ESD

Electrically conductive: fulfils requirements of EN 16350

The ideal solution for areas with explosive atmospheres

The high demands placed on safety gloves for use in areas with risk of explosions are defined in norm EN 16350. Contact resistance of safety gloves must be extremely low.

An innovative liner concept featuring a new conductive coating ensures chemical protection in addition to explosion protection.

Functional combination of liner and coating

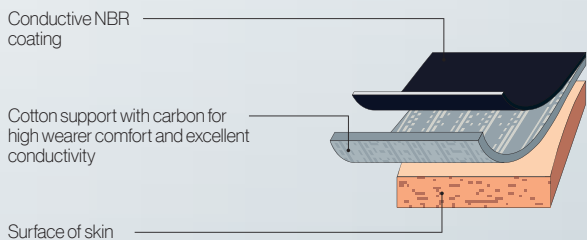

uvex rubiflex XG

Grip coating for optimised grip when working with oils



Good grip is essential in many environments. This also applies to hand protection as poor grip results in unnecessary exertion, unsafe working and increased risk of injury. The innovative uvex Xtra Grip Technology effectively and safely solves these problems.

Effective grip – high flexibility – outstanding wearer comfort

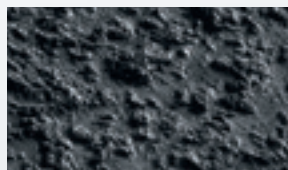

Mechanical strength
Together with the multilayer design, the advanced surface structure ensures a greater resistance time.

Use in oily and wet environments
The canal structure of the uvex Xtra grip technology gloves absorbs liquids, helping maintain a secure grip on tools and components.

The multilayer construction ensures safety and grip

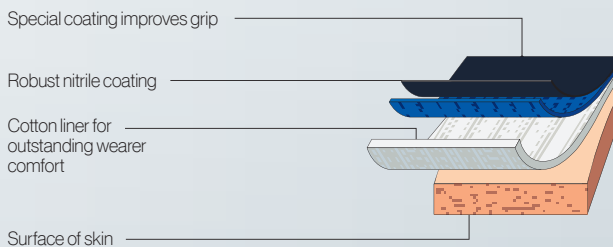

Chemical Risks

Safety gloves with cotton support: conductive NBR coating

The ideal solution for areas with explosive atmospheres

The introduction of the new standard EN 16350:2014 (Protective gloves – electrostatic properties) is the first standard to prescribe the electrostatic properties and testing procedure of safety gloves for work environments with risk of explosive atmospheres and fire.

- The testing conditions and minimum requirements in accordance with EN 16350:2014 are as follows:
- The contact resistance must be less than $1.0 \times 10^8 \Omega$ ($R_V < 1.0 \times 10^8 \Omega$).
- Contact resistance R_V was tested in accordance with EN 1149-2:1997.
- Test atmosphere: ambient temperature $23^\circ\text{C} \pm 1^\circ\text{C}$, relative air humidity $25\% \pm 5\%$.

uvex rubiflex ESD fulfils the requirements of the new norm EN 16350:2014.



EN ISO 374-1:2016/Type A



JKLOPT

EN 388:2016



2111X

60954



MADE IN GERMANY

Functional combination of liner and coating

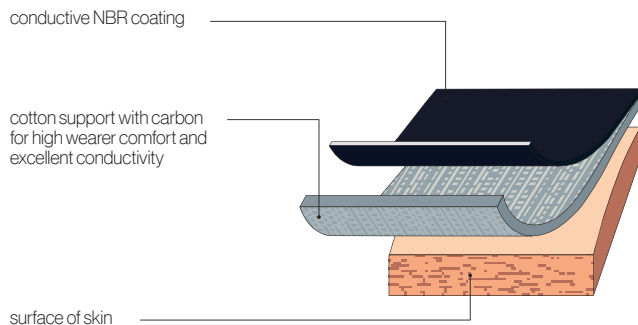

uvex rubiflex ESD

- lightweight, stockinette and anti-static NBR chemical protection glove for applications in areas with explosion risks
- good mechanical abrasion resistance thanks to the NBR coating
- good grip in damp and wet areas
- good resistance to grease, mineral oils and many chemicals
- meets the requirements of EN 16350:2014
- outstanding tactile feel
- ergonomic fit
- outstanding wearer comfort due to the high-quality cotton interlock/carbon supporting material
- extremely high flexibility

Areas of application:

- automotive industry
- chemical industry
- paint shop
- refineries
- plastics processing operations
- work in anti-static areas

| | |
|---------------------------------|--|
| | uvex rubiflex ESD NB35A |
| Art. no. | 60954 |
| Design | gauntlet, approx. 35 cm |
| Standard | EN 388 (2111X), EN ISO 374-1:2016 / Type A (JKLOPT), DIN EN 16350:2014 |
| Material | cotton interlock/carbon |
| Coating | fully coated with special conductive NBR coating (nitrile rubber), approx. 0.40 mm |
| Suitable for | good resistance to grease, mineral oils and many chemicals |
| Colour | black |
| Sizes | 6 to 11 |
| Order quantity multiples | 10 PR |

Chemical Risks

Safety gloves with cotton support: NBR coating



EN ISO 374-1:2016/Type A



JKN OPT

EN 388:2016



3121X

60557



MADE IN GERMANY



EN ISO 374-1:2016/Type A



JKN OPT

EN 388:2016



2111X

60224



MADE IN GERMANY

uvex rubiflex S XG

- lightweight, stockinette NBR chemical protection glove with optimal grip properties
- very good mechanical abrasion resistance and good lifecycle thanks to multi-layered structure
- outstanding grip in wet and oily areas thanks to uvex Xtra Grip technology
- good resistance to grease, mineral oils and many chemicals
- very good tactile feel
- ergonomic fit
- outstanding wearer comfort due to the high-quality cotton interlock supporting material
- extremely high flexibility

Areas of application:

- automotive industry
- chemical industry
- laboratories
- maintenance
- processing

| Art. no. | uvex rubiflex S XG27B | uvex rubiflex S XG35B |
|--------------------------|---|---|
| Art. no. | 60560 | 60557 |
| Design | gauntlet, approx. 27 cm | gauntlet, approx. 35 cm |
| Standard | EN 388 (3 1 2 1 X) EN ISO 374-1:2016/Type A (J K N O P T) | EN 388 (3 1 2 1 X) |
| Material | cotton interlock | cotton interlock |
| Coating | fully coated with special NBR coating (nitrile rubber) and XG Grip coating, approx. 0.40 mm | fully coated with special NBR coating (nitrile rubber) and XG Grip coating, approx. 0.40 mm |
| Suitable for | very good resistance to grease, mineral oils and many chemicals | very good resistance to grease, mineral oils and many chemicals |
| Colour | blue, black | blue, black |
| Sizes | 7 to 11 | 7 to 11 |
| Order quantity multiples | 10 PR | 10 PR |

uvex rubiflex S

- very lightweight, stockinette NBR chemical protection glove suited to handling a variety of chemicals
- good mechanical abrasion resistance thanks to the NBR coating
- good grip in damp and wet areas
- good resistance to grease, mineral oils and many chemicals
- outstanding tactile feel
- ergonomic fit
- outstanding wearer comfort due to the high-quality cotton interlock supporting material
- extremely high flexibility

Areas of application:

- automotive sector
- chemical industry
- laboratories
- varnishing
- food processing

| Art. no. | uvex rubiflex S NB27B | uvex rubiflex S NB35B |
|--------------------------|---|---|
| Art. no. | 60271 | 60224 |
| Design | gauntlet, approx. 27 cm | gauntlet, approx. 35 cm |
| Standard | EN 388 (2 1 1 1 X) EN ISO 374-1:2016/Type A (J K N O P T) | EN 388 (2 1 1 1 X) |
| Material | cotton interlock | cotton interlock |
| Coating | fully coated with special NBR coating (nitrile rubber), approx. 0.40 mm | fully coated with special NBR coating (nitrile rubber), approx. 0.40 mm |
| Suitable for | good resistance to grease, mineral oils and many chemicals | good resistance to grease, mineral oils and many chemicals |
| Colour | blue | blue |
| Sizes | 7 to 11 | 6 to 11 |
| Order quantity multiples | 10 PR | 10 PR |



Chemical Risks

Safety gloves with cotton support: NBR coating



uvex rubiflex S

- NBR chemical protection glove with reinforced cotton interlock supporting material
 - good mechanical abrasion resistance thanks to the NBR coating
 - good resistance to many chemicals, acids, alkalis, mineral oils and solvents
 - good heat insulation with reinforced supporting material
 - good tactile feel
 - ergonomic fit
 - outstanding wearer comfort due to the high-quality cotton interlock supporting material
 - highly flexible
- Areas of application:
- automotive industry
 - chemical industry
 - machinery and tool manufacturing
 - metal processing
 - sandblasting
 - food processing

| uvex rubiflex S | NB27S | NB35S | NB40S |
|---------------------------------|---|---|---|
| Art. no. | 89646 | 98891 | 98902 |
| Design | gauntlet, approx. 27 cm | gauntlet, approx. 35 cm | gauntlet, approx. 40 cm |
| Standard | EN 388 (2 1 2 1 X), EN ISO 374-1:2016 / Type A (J K N O P T) | | |
| Material | cotton interlock, reinforced | cotton interlock, reinforced | cotton interlock, reinforced |
| Coating | fully coated with NBR special coating (nitrile rubber), approx. 0.50 mm | fully coated with NBR special coating (nitrile rubber), approx. 0.50 mm | fully coated with NBR special coating (nitrile rubber), approx. 0.50 mm |
| Suitable for | very good resistance to grease, mineral oils and many chemicals | | |
| Colour | green | green | green |
| Sizes | 8 to 11 | 8 to 11 | 8 to 11 |
| Order quantity multiples | 10 PR | 10 PR | 10 PR |

uvex rubiflex S (long version)

- long NBR chemical protection glove with reinforced cotton interlock supporting material
 - additional elastic collar at gauntlet end (NB60SZ/NB80SZ)
 - good mechanical abrasion resistance thanks to the NBR coating
 - good resistance to many chemicals, acids, alkalis, mineral oils and solvents
 - good tactile feel
 - ergonomic fit
 - outstanding wearer comfort due to the high-quality cotton interlock supporting material
 - highly flexible
- Areas of application:
- chemical industry
 - sewer construction
 - municipal cleaning
 - sandblasting

| uvex rubiflex S | NB60S | NB80S | NB60SZ | NB80SZ |
|---------------------------------|---|------------------------------|---|---|
| Art. no. | 89647 | 60190 | 89651 | 60191 |
| Design | gauntlet, approx. 60 cm | gauntlet, approx. 80 cm | elastic collar at gauntlet end, approx. 60 cm | elastic collar at gauntlet end, approx. 80 cm |
| Standard | EN 388 (2 1 2 1 X), EN ISO 374-1:2016/Type B (J K O P T) | | | |
| Material | cotton interlock, reinforced | cotton interlock, reinforced | cotton interlock, reinforced | cotton interlock, reinforced |
| Coating | fully coated with special NBR coating (nitrile rubber), approx. 0.50 mm | | | |
| Suitable for | very good resistance to grease, mineral oils and many chemicals | | | |
| Colour | green | green | green | green |
| Sizes | 9 to 11 | 9 to 11 | 9 to 11 | 9 to 11 |
| Order quantity multiples | 10 PR | 10 PR | 10 PR | 10 PR |

Chemical Risks

Safety gloves with bamboo-fiber



60971



60972

uvex u-chem 3300

- outstanding wearer comfort
- comfortable bamboo-fiber inside
- absorption function of the natural fiber
- extremely high dexterity
- outstanding tactile feel good resistance to many chemicals

Areas of application:

- chemical industry
- printing industry
- inspection/maintenance
- laboratories
- painting work
- food processing
- pharmaceutical industry
- cleaning

uvex u-chem 3200

- best grip in oily conditions
- flexibility and grip
- good mechanical properties
- excellent fit

Areas of application:

- construction industry
- chemical industry
- printing industry
- inspection/maintenance work
- metalworking (cleaning)
- metal processing industry
- petroleum industry
- oil and gas industry
- petrochemicals



| | |
|---------------------------------|--|
| | uvex u-chem 3300 |
| Art. no. | 60971 |
| Design | cuff, fully coated, approx. 32 cm |
| Standard | EN 388 (2121X), EN ISO 374-1:2016 / Type A (J K L O P T) |
| Material | Bamboo-rayon/Nylon |
| Coating | NBR (nitrile butadiene rubber), approx. 0.21 mm |
| Suitable for | good resistance to grease, mineral oils and many chemicals |
| Colour | blue |
| Sizes | 7 to 11 |
| Order quantity multiples | 10 PR |

| | |
|---------------------------------|--|
| | uvex u-chem 3200 |
| Art. no. | 60972 |
| Design | cuff, fully coated, approx. 35 cm |
| Standard | EN 388 (3131X), EN ISO 374-1:2016 / Type A (J K L M O T) |
| Material | nylon weave |
| Coating | NBR (nitrile butadiene rubber), approx. 0.50 mm |
| Suitable for | good resistance to grease, mineral oils and many chemicals |
| Colour | petrol, black |
| Sizes | 7 to 12 |
| Order quantity multiples | 10 PR |

Chemical Risks

Safety gloves with bamboo-fiber



60961

- 

EN 407
X1X XXX
- 

EN ISO 374-1:2016/Type A
AJKLOT
- 

EN 388:2016
4131X



60968

- 

EN ISO 374-1:2016/Type A
AJKLMO
- 

EN 388:2016
4121X

uvex u-chem 3000

- full chemical protection glove, certified in line with EN 374 (AJKLOT)
- good mechanical protection
- good chemical resistance
- good mechanical resistance
- long service life

Areas of application:

- maintenance
- metal working
- cleaning
- chemical industry
- printing industry

uvex u-chem 3100

- the perfect combination of chemical protection and grip
- very good mechanical protection
- comfortable fit due to seamless cotton liner
- good resistance to many chemicals
- very good grip in wet and oily conditions
- highly flexible

Areas of application:

- chemical industry
- automotive industry
- metal working
- mechanical industries, sand blasting

| | |
|---------------------------------|--|
| | uvex u-chem 3000 |
| Art. no. | 60961 |
| Design | cuff, fully coated, approx. 35 cm |
| Standard | EN 388 (4 1 3 1 X), EN ISO 374-1:2016 / Type A (A J K L O T) |
| | EN 407 (X 1 X X X X) |
| Material | cotton interlock |
| Coating | NBR (nitrile butadiene rubber), approx. 0.50 mm |
| Suitable for | good resistance to grease, mineral oils and many chemicals |
| Colour | green |
| Sizes | 7 to 11 |
| Order quantity multiples | 10 PR |

| | |
|---------------------------------|--|
| | uvex u-chem 3100 |
| Art. no. | 60968 |
| Design | cuff, fully coated, approx. 30 cm |
| Standard | EN 388 (4 1 2 1 X), EN ISO 374-1:2016 / Type A (A J K L M O) |
| Material | cotton (seamless) |
| Coating | NBR (nitrile butadiene rubber), approx. 0.50 mm |
| Suitable for | good resistance to grease, mineral oils and many chemicals |
| Colour | black |
| Sizes | 8 to 11 |
| Order quantity multiples | 10 PR |

Mechanical Risks

Area of application: cut protection

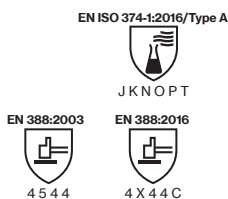

60535

60536



MADE IN GERMANY

uvex protector chemical

- very robust safety glove with multi-layer technology combining impermeability and optimal cut protection
- very high level of cut protection with the multi-layer design of the supporting material made from cotton, HPPE and glass
- good grip in damp, wet and oily areas
- uvex protector chemical also offers protection against chemicals
- good wearer comfort

Areas of application:

- work with high cut hazard and contact with chemicals
- handling heavy-duty tools
- sheet metal processing
- machinery and tool manufacturing

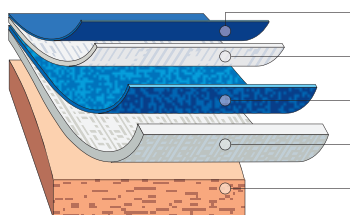

NBR impregnation for enhanced grip
 high cut-resistant HPPE/glass/polyamide
 nitrile coating to protect against chemicals
 cotton layer for outstanding wearer comfort
 surface of skin



| | | |
|---------------------------------|---|---|
| | uvex protector chemical NK2725B | uvex protector chemical NK4025B |
| Art. no. | 60535 | 60536 |
| Design | gauntlet, approx. 27 cm | gauntlet, approx. 40 cm |
| Standard | EN 388 (4 X 4 4 C), EN ISO 374-1:2016/Type A (J K N O P T) | EN 388 (4 X 4 4 C), EN ISO 374-1:2016/Type A (J K N O P T) |
| Material | sandwich liner: cotton interlock, HPPE, glass, PA | sandwich liner: cotton interlock, HPPE, glass, PA |
| Coating | fully coated with special NBR coating (nitrile rubber) | fully coated with special NBR coating (nitrile rubber) |
| Suitable for | good resistance to oil, grease and many chemicals | good resistance to oil, grease and many chemicals |
| Colour | blue | blue |
| Sizes | 9 to 10 | 9 to 10 |
| Order quantity multiples | 10 PR | 10 PR |



Chemical Risks

Unsupported safety gloves



uvex profastrong

- sensitive NBR chemical protection glove with flocked cotton
- outstanding mechanical abrasion resistance
- good grip in damp and wet areas thanks to the Grip structure in the palm
- good resistance to many oils, grease, acids and alkalis
- good tactile feel
- good fit
- highly flexible

- Areas of application:
- automotive industry
 - chemical industry
 - printing industry
 - laboratories
 - food industry

uvex profapren

- flexible chloroprene chemical protection glove with flocked cotton
- good grip in damp and wet areas thanks to the Grip structure in the palm
- good resistance to many chemicals and solvents
- good tactile feel
- very good fit
- highly flexible

- Areas of application:
- chemical industry
 - printing industry
 - metalworking (cleaning)
 - cleaning work

| | |
|--------------------------|--|
| Art. no. | uvex profastrong NF33 60122 |
| Design | gauntlet, palm with grip structure, approx. 33 cm |
| Standard | EN 388 (4 1 0 1 X), EN ISO 374-1:2016/Type A (A J K L O T) |
| Material | flocked cotton |
| Coating | fully coated with NBR (nitrile rubber), approx. 0.38 mm |
| Suitable for | good resistance to oils, grease, acids and solvents |
| Colour | green |
| Sizes | 7 to 11 |
| Order quantity multiples | 12 PR |

| | |
|--------------------------|--|
| Art. no. | uvex profapren CF33 60119 |
| Design | gauntlet, roughened palm, approx. 33 cm |
| Standard | EN 388 (3 1 3 1 X), EN ISO 374-1:2016/Type A (A K L M N O) |
| Material | flocked cotton |
| Coating | fully coated with polychloroprene (latex inner), approx. 0.71 mm |
| Suitable for | good resistance to many chemicals |
| Colour | dark blue |
| Sizes | 7 to 10 |
| Order quantity multiples | 10 PR |

Chemical Risks

Unsupported safety gloves



EN ISO 374-1:2016/Type A

 A B I K L N O T
 EN 388:2016

 2 0 1 0 X

60949

MADE IN GERMANY 



EN ISO 374-1:2016/Type A

 A F K L M N
 EN 388:2016

 2 1 2 0 A

60957

MADE IN GERMANY 



uvex profabutyl

- chemical protection glove without stockinette made from butyl rubber
- good grip in damp and wet areas
- good resistance to polar bonds such as esters, ketones, aldehydes, amines and saturated saline solutions, plus acids and alkalis
- good fit
- highly flexible
- satisfies the requirements of DIN EN 16350:2014

Areas of application:

- chemical industry
- working in antistatic areas

| | |
|---------------------|---|
| | uvex profabutyl B-05R |
| Art. no. | 60949 |
| Design | gauntlet, rolled edge, approx. 35 cm |
| Standard | EN 388 (2 0 1 0 X), EN 374 (A B I K L N O T) |
| Material | without stockinette |
| Coating | seamlessly coated with bromobutyl (approx. 0.50 mm) |
| Suitable for | good resistance to polar bonds acids and alkalis |
| Colour | black |
| Sizes | 7 to 11 |
| Order unit | PR |

uvex profaviton

- chemical protection gloves made from butyl rubber with Viton® outer layer
- good grip in damp and wet areas
- good resistance to aliphatic and aromatic hydrocarbons (e.g. hexane, benzene, toluene, xylene and others), halogenated hydrocarbons (e.g. trichloroethylene, perchloroethylene, dichloromethane and others) organic and inorganic acids (diluted to concentrated), as well as saturated saline solutions
- good fit
- highly flexible

Areas of application:

- chemical industry

| | |
|---------------------|--|
| | uvex profaviton BV-06 |
| Art. no. | 60957 |
| Design | gauntlet, rolled edge, approx. 35 cm |
| Standard | EN 388 (2 1 2 0 A), EN ISO 374-1:2016/Type A (A F K L M N) |
| Material | without stockinette |
| Coating | seamlessly coated with bromobutyl (approx. 0.40 mm) and Viton® outer layer (approx. 0.20 mm) |
| Suitable for | good resistance to aliphatic and aromatic hydrocarbons, halogenated hydrocarbons |
| Colour | black |
| Sizes | 8 to 11 |
| Order unit | PR |

Chemical Risks

Disposable safety gloves

The uvex u-fit product range, provides high-quality disposable safety gloves, which guarantee a high level of safety and functionality.

uvex u-fit gloves ensures reliable wearer protection throughout industry, including the chemical, medical, food and light industry sectors enabling comfortable and precise work.

uvex disposable safety gloves are available in three different materials to cater for a wide range of application areas:

- uvex u-fit lite
- uvex u-fit
- uvex u-fit strong N2000

| | uvex u-fit lite | uvex u-fit | uvex u-fit strong N2000 |
|-----------------|---|---|--|
| Material | accelerator-free NBR (nitrile rubber) | NBR (nitrile rubber) | NBR (nitrile rubber) |
| | wall thickness 0.08mm | wall thickness 0.10mm | wall thickness 0.20 mm |
| | silicone-free | silicone-free | silicone-free |
| | powder-free | powder-free | powder-free |
| | no latex proteins | no latex proteins | no latex proteins |
| Certification | EN ISO 374 | EN ISO 374 | EN ISO 374 |
| | handling foodstuffs | handling foodstuffs | handling foodstuffs |
| Characteristics | high level of sensitivity | good mechanical abrasion resistance | very good abrasion resistance |
| | hypo-allergenic | good chemical resistance (splashproof) | increased chemical resistance (splash-proof) |
| Handling | reinforced rolled edge – easy to put on | reinforced rolled edge – easy to put on | reinforced rolled edge – easy to put on |



Please contact us if you require a copy of our complete resistance list.

Detailed information can also be found in the uvex Chemical Expert System online at <https://ces.uvex.de>

| Area of application | uvex u-fit lite | uvex u-fit | uvex u-fit strong N2000 |
|-----------------------------------|---|---|---|
| Precision assembly work, dry/oily | ++ | + | - |
| Assembly work, dry/oily | + | + | ++ |
| Product protection | ++ | ++ | + |
| Gentle cleaning | + | + | ++ |
| Inspection | ++ | ++ | + |
| Food handling | + | + | + |
| Chemicals | short-term work, in acc. with resistance list | short-term work, in acc. with resistance list | in acc. with resistance list |
| Paint shop | as splash protection | as splash protection | full contact in acc. with resistance list |

Chemical Risks

Disposable safety gloves

Accelerator-free



EN ISO 374-1:2016 / Type C



60597



EN ISO 374-1:2016 / Type B



K P T



60596



EN ISO 374-1:2016 / Type A



J K L O P S T



60962



uvex u-fit lite

- very light and thin NBR disposable glove (0.08 mm)
- good grip with the roughened fingertips
- good mechanical resistance
- reliable spray protection when handling chemicals such as acids, alkalis, solids or aqueous saline solutions
- silicone-free according to imprint test
- outstanding tactile feel
- very good fit
- extremely high flexibility
- accelerator-free

Areas of application:

- precision assembly work
- inspection
- short periods handling chemicals
- paint shop (as splash protection)
- food processing
- gentle cleaning
- product protection

uvex u-fit

- thin and reliable NBR disposable glove (0.10 mm)
- good grip with the roughened surface
- very good abrasion resistance
- reliable spray protection when handling chemicals such as acids, alkalis, solids or aqueous saline solutions
- silicone-free according to imprint test
- outstanding tactile feel
- very good fit
- extremely high flexibility

Areas of application:

- precision assembly work
- inspection
- short periods handling chemicals
- paint shop (as splash protection)
- food processing
- gentle cleaning
- product protection

uvex u-fit strong N2000

- reinforced disposable glove made from nitrile rubber (0.20 mm)
- for protection against many chemicals
- good grip
- outstanding tactile feel
- very high mechanical strength
- silicone-free according to imprint test

Areas of application:

- laboratories
- chemical industry
- precision assembly work
- painting work
- cleaning
- food industry



| | uvex u-fit lite |
|---------------------|---------------------------------------|
| Art. no. | 60597 |
| Design | roughened fingertips, approx. 24 cm |
| Standard | EN ISO 374-1:2016/Type C |
| Material | without stockinette |
| Coating | NBR (nitrile rubber), approx. 0.08 mm |
| Suitable for | highly resistant to grease and oil |
| Colour | indigo blue |
| Sizes | S to XL |
| Order unit | BOX |
| Content | box of 100 PC |

| | uvex u-fit |
|---------------------|---------------------------------------|
| Art. no. | 60596 |
| Design | roughened surface, approx. 24 cm |
| Standard | EN ISO 374-1:2016/Type B (KPT) |
| Material | without stockinette |
| Coating | NBR (nitrile rubber), approx. 0.10 mm |
| Suitable for | highly resistant to grease and oil |
| Colour | blue |
| Sizes | S to XL |
| Order unit | BOX |
| Content | box of 100 PC |

| | uvex u-fit strong N2000 |
|---------------------|--|
| Art. no. | 60962 |
| Design | textured surface of fingertips, approx. 28 cm |
| Standard | EN ISO 374-1:2016/Type A (J K L O P S T) |
| Material | no lining |
| Coating | NBR (nitrile butadiene rubber) |
| Suitable for | good resistance to grease, mineral oils and many chemicals |
| Colour | blue |
| Sizes | S to XXL |
| Order unit | BOX |
| Content | box of 50 PC |

Safety Gloves

Overview

| Art. no. | Art. code | Sizes | Colour | Page |
|----------|-----------------------------|-----------|-------------------------|------|
| 60021 | uvex synexo M100 | 7 to 11 | red, black | 226 |
| 60022 | uvex synexo M500 | 7 to 11 | yellow, black | 227 |
| 60027 | uvex athletic lite | 6 to 11 | blue, anthracite | 214 |
| 60028 | uvex athletic allround | 6 to 11 | grey, anthracite | 214 |
| 60030 | uvex athletic D5 XP | 6 to 11 | grey, anthracite | 240 |
| 60038 | uvex phynomic airLite A ESD | 6 to 12 | black | 208 |
| 60040 | uvex phynomic lite | 5 to 12 | grey, grey | 212 |
| 60041 | uvex phynomic lite w | 5 to 12 | white, white | 212 |
| 60049 | uvex phynomic allround | 5 to 12 | grey, black | 209 |
| 60050 | uvex phynomic foam | 5 to 12 | white, grey | 209 |
| 60054 | uvex phynomic x-foam HV | 6 to 12 | orange, grey | 211 |
| 60060 | uvex phynomic wet | 6 to 12 | blue, anthracite | 210 |
| 60061 | uvex phynomic wet plus | 6 to 12 | blue, anthracite | 210 |
| 60062 | uvex phynomic pro | 6 to 12 | blue, anthracite | 210 |
| 60070 | uvex phynomic XG | 6 to 12 | black, black | 230 |
| 60078 | uvex phynomic airLite B ESD | 6 to 12 | light blue | 209 |
| 60080 | uvex phynomic C3 | 6 to 12 | sky blue | 231 |
| 60081 | uvex phynomic C5 | 6 to 12 | blue, grey | 231 |
| 60084 | uvex phynomic airLite C ESD | 6 to 12 | light blue | 230 |
| 60119 | uvex profapren CF33 | 7 to 10 | dark blue | 252 |
| 60122 | uvex profastrong NF33 | 7 to 11 | green | 252 |
| 60135 | uvex unigrip 6620 | 7 to 10 | white, blue | 217 |
| 60147 | uvex profi ergo ENB20A | 6 to 11 | white, orange | 220 |
| 60148 | uvex profi ergo ENB20 | 6 to 10 | white, orange | 220 |
| 60150 | uvex contact ergo | 6 to 10 | white, orange | 220 |
| 60179 | uvex k-basic extra 6658 | 8, 10, 12 | yellow | 224 |
| 60190 | uvex rubiflex S NB80S | 9 to 11 | green | 248 |
| 60191 | uvex rubiflex S NB80SZ | 9 to 11 | green | 248 |
| 60202 | uvex NK4022 | 9 to 10 | orange | 224 |
| 60208 | uvex profi ergo XG20 | 6 to 11 | white, orange, black | 221 |
| 60210 | uvex unidur 6641 | 6 to 11 | white, grey | 238 |
| 60213 | uvex NK2722 | 9 to 10 | orange | 224 |
| 60224 | uvex rubiflex S NB35B | 7 to 11 | blue | 247 |
| 60238 | uvex unigrip 6624 | 7 to 10 | grey, red | 217 |
| 60248 | uvex unipur 6639 | 6 to 11 | black, black | 216 |
| 60271 | uvex rubiflex S NB27B | 7 to 11 | blue | 247 |
| 60276 | uvex rubipor XS2001 | 6 to 10 | white, white | 213 |
| 60314 | uvex unidur 6643 | 7 to 10 | mottled grey, black | 238 |
| 60316 | uvex rubipor XS5001B | 6 to 10 | white, blue | 213 |
| 60321 | uvex unipur 6634 | 7 to 10 | grey, black | 215 |
| 60491 | uvex C500 sleeve | M, L | lime | 235 |
| 60492 | uvex C500 wet | 7 to 11 | lime, anthracite | 236 |
| 60494 | uvex C500 foam | 7 to 11 | lime, anthracite | 236 |
| 60496 | uvex C500 wet plus | 7 to 11 | lime, anthracite | 235 |
| 60497 | uvex C500 | 7 to 11 | lime | 235 |
| 60498 | uvex C500 M foam | 7 to 11 | lime, black, anthracite | 234 |
| 60499 | uvex C500 dry | 7 to 11 | lime, anthracite | 236 |

| Art. no. | Art. code | Sizes | Colour | Page |
|----------|---------------------------------|----------|----------------------|------|
| 60516 | uvex unidur 6649 | 7 to 11 | mottled grey, grey | 239 |
| 60535 | uvex protector chemical NK2725B | 9 to 10 | blue | 251 |
| 60536 | uvex protector chemical NK4025B | 9 to 10 | blue | 251 |
| 60542 | uvex C300 wet | 7 to 11 | anthracite | 237 |
| 60544 | uvex C300 foam | 7 to 11 | anthracite | 237 |
| 60549 | uvex C300 dry | 7 to 11 | anthracite | 237 |
| 60556 | uvex unipur carbon | 6 to 10 | grey | 217 |
| 60557 | uvex rubiflex S XG35B | 7 to 11 | blue, black | 247 |
| 60558 | uvex profi ergo XG20A | 6 to 11 | white, orange, black | 221 |
| 60560 | uvex rubiflex S XG27B | 7 to 11 | blue, black | 247 |
| 60573 | uvex unilite 6605 | 6 to 11 | black, black | 215 |
| 60585 | uvex unilite 7700 | 7 to 11 | grey, black | 215 |
| 60587 | uvex unipur carbon FT | 6 to 10 | grey | 217 |
| 60591 | uvex unilite thermo plus cut C | 7 to 11 | lime, black | 225 |
| 60592 | uvex unilite thermo plus | 7 to 11 | black | 225 |
| 60593 | uvex unilite thermo | 7 to 11 | black | 225 |
| 60595 | uvex profatherm XB40 | 11 | white | 224 |
| 60596 | uvex u-fit | S to XL | blue | 255 |
| 60597 | uvex u-fit lite | S to XL | indigo blue | 255 |
| 60598 | uvex synexo impact 1 | 7 to 11 | yellow, black | 227 |
| 60600 | uvex C500 XG | 7 to 11 | lime, anthracite | 235 |
| 60604 | uvex D500 foam | 7 to 11 | lime, anthracite | 234 |
| 60932 | uvex unidur 6648 | 6 to 11 | white, black | 239 |
| 60938 | uvex unidur 6659 foam | 6 to 11 | mottled grey, black | 240 |
| 60942 | uvex unilite thermo HD | 8 to 11 | orange, black | 225 |
| 60943 | uvex unipur 6630 | 6 to 11 | white | 216 |
| 60944 | uvex unipur 6631 | 6 to 11 | grey | 216 |
| 60945 | uvex compact NB27H | 10 | white, blue | 222 |
| 60946 | uvex compact NB27E | 9 to 10 | white, blue | 222 |
| 60949 | uvex profabutyl B-05R | 7 to 11 | black | 253 |
| 60954 | uvex rubiflex ESD NB35A | 6 to 11 | black | 246 |
| 60957 | uvex profaviton BV-06 | 8 to 11 | black | 253 |
| 60961 | uvex u-chem 3000 | 7 to 11 | green | 250 |
| 60962 | uvex u-strong N2000 | S to XXL | blue | 255 |
| 60968 | uvex u-chem 3100 | 8 to 11 | black | 250 |
| 60969 | uvex unidur 6679 foam | 6 to 11 | grey, black | 240 |
| 60971 | uvex u-chem 3300 | 7 to 11 | blue | 249 |
| 60972 | uvex u-chem 3200 | 7 to 12 | petrol, black | 249 |
| 60973 | uvex unidur sleeve C | M, L | mottled grey | 241 |
| 60974 | uvex unidur sleeve C TL | M, L | mottled grey | 241 |
| 89636 | uvex rubiflex NB27 | 7 to 11 | orange | 222 |
| 89646 | uvex rubiflex S NB27S | 8 to 11 | green | 248 |
| 89647 | uvex rubiflex S NB60S | 9 to 11 | green | 248 |
| 89651 | uvex rubiflex S NB60SZ | 9 to 11 | green | 248 |
| 98891 | uvex rubiflex S NB35S | 8 to 11 | green | 248 |
| 98902 | uvex rubiflex S NB40S | 8 to 11 | green | 248 |



uvex



Safety Footwear

uvex climazone

Innovative climate management

To effectively improve the climate in occupational safety equipment, it is essential to analyse relevant factors to investigate and understand how they work together.

uvex has been researching the impact of climate issues for many years. In collaboration with well-known institutes such as PFI (Pirmasens Testing and Research Institute), the Kaiserslautern Technical College and the Hohenstein Institute, testing methods and devices have been developed to enable a comprehensive and proven measurement of climate characteristics.

Are your feet too hot or too cold? Is excess perspiration making you feel unwell? Effective temperature control is particularly important in the field of safety footwear.

- The comfort factor with uvex climazone:
- Regulates individual body temperature
 - Work with a lasting sense of well-being
 - Longer-lasting performance
 - Optimum wearer comfort in any situation

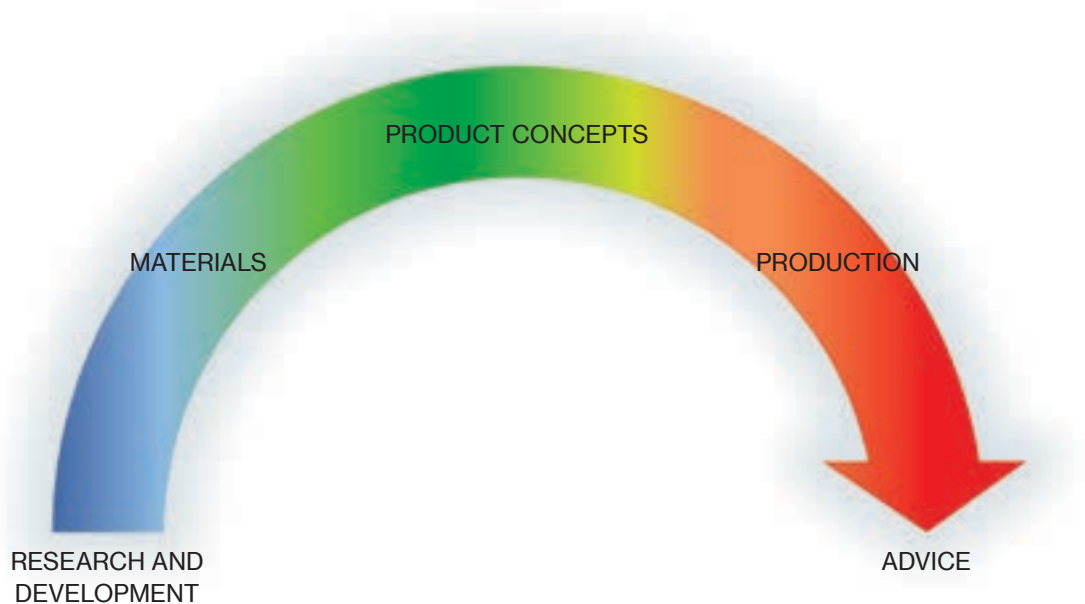

Our partners in research and technology



Fachhochschule
Kaiserslautern
University of Applied Sciences



uvex climazone is the innovative head-to-toe climate-control system. uvex has combined its expertise in research and development with the use of intelligent materials and processing technology to create a unique range of climate-optimising products.

climazone

All products which have the innovative climate management features carry the uvex climazone symbol throughout this catalogue.



During intense physical activity, sweat production by the feet can fill a glass of water by the end of the day. uvex climazone wicks this moisture away reducing the risk of discomfort caused by blisters, fungal infections or even mild hypothermia and damage the footwear or socks.

The boa® fit system.

Delivering fit solutions purpose-built for performance, the Boa® Fit System is featured in products across industries (in medical, sports and workwear) and consists of three integral parts: a micro-adjustable dial, a super-strong lightweight lace and low friction lace guides. Each unique configuration is engineered for effortless precision delivering a connected, fast, customized and durable fit, and is backed by The Boa Guarantee.

Dial A dial that adjusts fit with precision click by click.

Lace Lightweight, super-strong lace, expertly configured for comfort and performance.

Guides Low-friction guides to ensure a smooth closure, every time.

The boa® benefits.

Fit to perform.

Dial in your perfect fit for custom comfort that's consistent all-day, the micro-adjustable Boa Fit System is fast, easy and built to perform, so you can always get the job done.

Confidence in all conditions.

Designed to reduce contamination by shedding ice, dirt, oil and other elements, the Boa Fit System will work as hard as you do, so you can stay focused and confident in any environment – without ever having to remove your gloves.

Stay secure and focused.

Boa's precision engineered laces are contained inside the system, out of your way and out of machinery.

Built for life.

When we say tough, we mean it. Engineered with ultra-durable materials, the Boa Fit System is extensively tested in the harshest conditions.

Fit for life with boa®.

The Boa® Fit System dials and laces are guaranteed for the lifetime of the product on which they are integrated.

How it works.



push in to engage



turn to tighten



pull up for quick release

Models equipped with the Boa® Fit System can be found on pages 280, 289, 307, 309, 322, 333.

Website



uvex

uvex i-gonomics

Foot protection with measurably greater relief

uvex i-gonomics redefines wearer comfort: The innovative product system boasts an ergonomic fit, lightweight design and ideal climate characteristics. This makes our safety shoes more comfortable to wear and gives them optimal flexibility – so maximum performance can be achieved at all times, even under extreme conditions.



uvex 1 G2

The new uvex 1 G2 collection is the next generation of the successful uvex 1 series

The uvex i-PUREnrj two-layer outsole is made of a newly developed type of polyurethane. The midsole has an energy absorption of 40.8 joules, i.e. double the standard, while providing energy recovery of around 66% in the heel* and 59% in the forefoot*.

The tread of the outsole has been specially adapted to working on industrial floors, is shaped in accordance with the latest findings from biomechanical research and offers maximum slip resistance. All this combined with the proven collar concept ensure a high RI index of 4.03.

* Test report no.: L190714889 CTC Lyon – 22/08/2019



Scan for more information about the uvex i-gonomics product system.

force 4.2

Test method:
Energy absorption in the heel area

Test result:
Energy absorption = 40.8J (IV 4.2)

Reduced strain for more comfortable standing and walking



weight 3.0

Test method:
Weighing the shoe

Test result:
Product weight = 510g (IV 3.0)

Lightweight fit, reduced fatigue



Relief index calculation:

The relief index is calculated from the average of the three index values (IV) – force, weight and climate – and ranges from 0 (= poor) to 5 (= optimum).



clima 4.9

Test method:
Measuring the microclimate in the shoe

Test result:
Absolute humidity = 20.23 g/kg air (IV 4.9)

Less perspiration, drier feel, increased hygiene



Safety Footwear

Areas of application: light · medium · heavy



light
areas of application

'Light' covers all areas of application where work is primarily carried out indoors and there are no significant demands on the physical properties of the outsole. Examples include assembly workplaces, as well as storage and logistics areas.



medium
areas of application

'Medium' applications usually take place both indoors and outdoors, with the outsole needing to be significantly more robust. Typical users include manual labourers, public sector employers and people working the chemical industry.



heavy
areas of application

'Heavy' applications involve external influences that place extensive demands on the shoe, its durability and stability. They are usually found in heavy mechanical engineering and in the construction industry, especially in building and civil engineering.

Safety Footwear

Pictogram overview

climazone

uvex climazone is an innovative head-to-toe climate control system. uvex has combined its expertise in research and product development with the use of intelligent materials and processing technologies to develop a unique range of climate-optimising safety products, such as safety footwear. More details page 258.



ESD indicates the controlled discharge of electrostatic energy that can cause damage to electronic components in the event of uncontrolled discharge or trigger explosions. Safety footwear marked with the ESD symbol meets the ESD specification with a volume resistance of less than 35 megaohms. For a detailed explanation, see page 266.



Certain materials such as silicones, plasticisers and similar substances can impair the lacquer wetting of surfaces. The sole materials of footwear with this symbol has been tested accordingly by the automotive industry and approved.

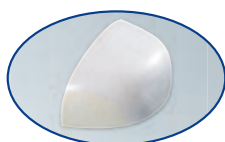

uvex xenova® system

The uvex xenova® system is a comprehensive, completely metal-free safety system to protect the foot inside safety footwear. Latest generation of uvex xenova® toe cap: the metal-free cap fits perfectly without pressure points. This delivers increased wearer comfort while kneeling and banging against obstacles. uvex xenova® penetration-resistant midsole: the metal-free flexible, penetration-resistant xenova® midsole exactly matches the dimensions of the insole. It covers 100% of the sole area and protects against cold getting inside, which adds to wearing comfort.



uvex medicare

uvex medicare designates safety footwear that has been certified for orthopaedic adjustment and orthopaedic shoes in accordance with German Institute for Occupational Health and Safety (DGUV) regulation 112-191 and/or Austrian ÖNORM Z 1259.



uvex construction

Especially suited to applications in the construction industry

BOA®

Delivering fit solutions purpose-built for performance, the Boa® Fit System is featured in products across sports, occupational safety and medical applications. Detailed explanation on page 259.



uvex women's and men's last

To ensure a proper fit for both men and women the last should vary according to the intended gender. Safety footwear marked with these symbols have been produced in sizes 35-40 using a last which mimics the contours of the female foot.



Safety Footwear

Standards · Labels

Labelling

Manufacturer's identification mark: **uvex**

CE symbol: **CE**

Manufacturer's type designation: **91 8543.8 42**

Number of European standard: **EN ISO 20345:2011**

Symbol for protection: **S1 SRC**

Date of manufacture: **07/2019**

Article number: [Symbol]

Postal address of the manufacturer: **Made/Produziert in Italy for/für UVEX ARBEITSSCHUTZ GMBH Würzburger Str. 181-189 D-90766 Fürth, Germany**

Footwear symbols for industrial usage

| Basic requirements/additional requirements/categories e.g. for leather shoes | Safety footwear EN ISO 20345 | Occupational footwear EN ISO 20347 |
|--|---------------------------------|---------------------------------------|
| Basic requirements for shoes and impact resistance of toecaps | SB 200 Joule | OB No requirement |
| Additional requirements: Closed seat region Antistatic properties Energy absorption of seat region Fuel resistance | S1 | O1 (without resistance to fuels) |
| Additional requirements: as above, plus water penetration and absorption | S2 | O2 |
| Additional requirements: as above, plus Penetration resistance* Cleated outsole | S3 | O3 |
| Basic requirements/additional requirements/categories e.g. for shoes made from PVC or PU | | |
| Basic requirements for shoes and impact resistance of toecaps | SB 200 Joule | OB No requirement |
| Additional requirements: Antistatic properties Energy absorption of seat region Fuel resistance Penetration resistance* Cleated outsole | S5 | O5 |
| The choice of a particular shoe depends on the type of occupational risk. As with all footwear, additional requirements may exist (e.g. in terms of heat and cold insulation, penetration resistance or electrical resistance via ESD). These shoes are then marked accordingly. The testing principles for all basic and additional requirements are specified in EN ISO 20344. | | |

One of the three following requirements must be met and labelled in the shoe.

| Label | Characteristics tested | Test conditions | Friction coefficient |
|-------|--|--|--|
| SRA | Slip resistance on ceramic tile floors with sodium lauryl sulfate solution (SLS) | Forward slip of the heel Forward slip on a flat surface | No less than 0.28 No less than 0.32 |
| SRB | Slip resistance on steel floors with glycerol | Forward slip of the heel Forward slip on a flat surface | No less than 0.13 No less than 0.18 |
| SRC | Slip resistance on ceramic tile floors with sodium lauryl sulfate solution and on steel floors with glycerol | Includes all test conditions cited under a. and b. | |

Additional requirements for special applications with corresponding symbols

| SYMBOL | RISK COVERED | EN ISO 20345 | | | | | EN ISO 20347 | | | |
|--------|--|--------------|----|----|----|----|--------------|----|----|----|
| | | SB | S1 | S2 | S3 | S5 | OB | O1 | O2 | O3 |
| - | Basic | ■ | ■ | ■ | ■ | ■ | ■ | ■ | ■ | ■ |
| P | Penetration resistance* | ■ | ■ | ■ | ■ | ■ | ■ | ■ | ■ | ■ |
| A | Antistatic footwear | ■ | ■ | ■ | ■ | ■ | ■ | ■ | ■ | ■ |
| E | Energy absorption around heel | ■ | ■ | ■ | ■ | ■ | ■ | ■ | ■ | ■ |
| HI | Heat insulation | ■ | ■ | ■ | ■ | ■ | ■ | ■ | ■ | ■ |
| CI | Cold insulation | ■ | ■ | ■ | ■ | ■ | ■ | ■ | ■ | ■ |
| WRU | Water resistance of upper | ■ | ■ | ■ | ■ | ■ | ■ | ■ | ■ | ■ |
| HRO | Heat resistance of outsole (+300 °C/min) | ■ | ■ | ■ | ■ | ■ | ■ | ■ | ■ | ■ |
| WR | Whole shoe waterproof | ■ | ■ | ■ | ■ | ■ | ■ | ■ | ■ | ■ |
| M | Metatarsal protection | ■ | ■ | ■ | ■ | ■ | ■ | ■ | ■ | ■ |
| FO | Resistance to oil and petrol | ■ | ■ | ■ | ■ | ■ | ■ | ■ | ■ | ■ |

■ Meets the specified requirement

■ Requirement can be met but is not stipulated

*** Penetration resistance**

Warning – Please note that the penetration resistance of this footwear has been measured in the laboratory using a truncated nail of diameter 4.5 mm and a force of 1100 N. Higher forces or nails of smaller diameter will increase the risk of penetration occurring. In such circumstances alternative preventative measures should be considered.

Two generic types of penetration resistant insert are currently available in PPE footwear. These are metal types and those from non-metal materials. Both types meet the minimum requirements for penetration resistance of the standard marked on this footwear but each has different additional advantages or disadvantages including the following:

Metal: Is less affected by the shape of the sharp object/hazard (i.e. diameter, geometry, sharpness) but due to shoemaking limitations does not cover the entire lower area of the shoe.

Non-metal: May be lighter, more flexible and provide greater coverage area when compared with metal but the penetration resistance may vary more depending on the shape of the sharp object/hazard (i.e. diameter, geometry, sharpness).

For more information about the type of penetration resistant insert provided in your footwear please contact the manufacturer or supplier detailed on these instructions.



Safety Footwear

ESD

Electrostatic

Controlling unwelcome electrostatic charge is becoming an increasingly important role in industry, as more and more employees come into contact with processes, materials or objects which are sensitive to electro static charge. It is often necessary to use safety footwear as part of a system to conduct electrostatic charge in such workplaces.

Independent of various measuring methods, volume resistance between 100 kilohms (1.0×10^5 ohms) and 35 megohms (3.5×10^7 ohms) is still required to fulfil the various relevant norms (e.g. EN ISO 20345, EN 61340).

All ESD-certified products in this catalogue feature the ESD symbol.



These products are also suitable in accordance with the specification for conductive footwear in the German Technical Rules for Hazardous Substances (TRGS) 727 "Avoiding risks of ignition resulting from electrostatic charges."

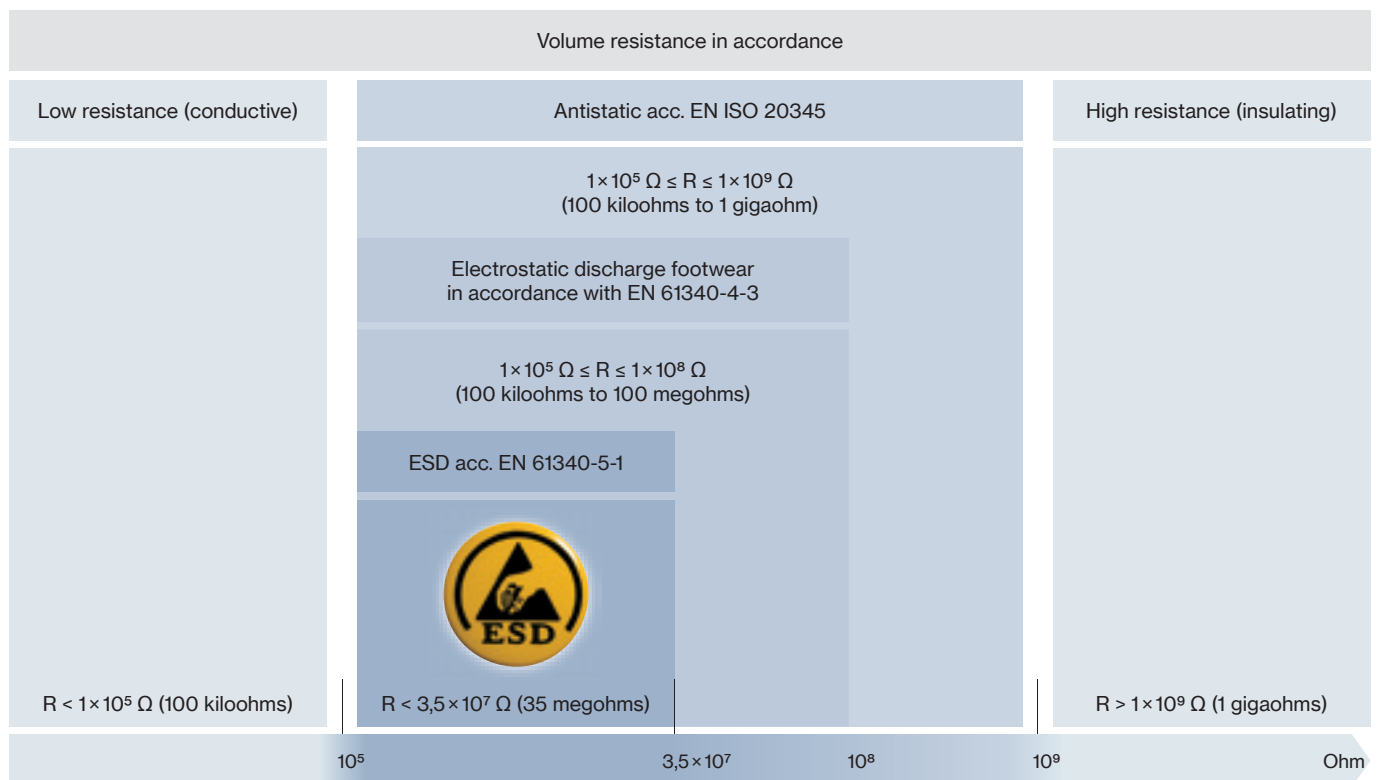

R = electrical resistance

Safety Footwear

uvex multiple fit system

uvex multiple fit system

As part of the safety footwear multiple fit system, a footwear style is offered in the same size but in a range of different fits. The different fits are based on the measurement of the widest part of the foot. A measurement can be taken of either the circumference of the foot at the base joint of the big toe and the base joint of the little toe or alternatively the width of the foot at this point (see opposite).

The classification of sizes and the corresponding values are detailed in the table below (all measurements in mm):



| uvex shoe size | Foot length | Width 10 Circum. | Width 11 (standard) Circum. | Width 12 Circum. | Width 14 Circum. |
|----------------|-------------|---------------------|--------------------------------|---------------------|---------------------|
| 35 | 217 | 216.5 | 222.5 | 228.5 | 240.5 |
| 36 | 225 | 221 | 227 | 233 | 245 |
| 37 | 232 | 225.5 | 231.5 | 237.5 | 249.5 |
| 38 | 240 | 230 | 236 | 242 | 254 |
| 39 | 247 | 234.5 | 240.5 | 246.5 | 258.5 |
| 40 | 255 | 239 | 245 | 251 | 263 |
| 41 | 262 | 243.5 | 249.5 | 255.5 | 267.5 |
| 42 | 270 | 248 | 254 | 260 | 272 |
| 43 | 277 | 252.5 | 258.5 | 264.5 | 276.5 |
| 44 | 285 | 257 | 263 | 269 | 281 |
| 45 | 292 | 261.5 | 267.5 | 273.5 | 285.5 |
| 46 | 300 | 266 | 272 | 278 | 290 |
| 47 | 307 | 270.5 | 276.5 | 282.5 | 294.5 |
| 48 | 315 | 275 | 281 | 287 | 299 |
| 49 | 322 | 279.5 | 285.5 | 291.5 | 303.5 |
| 50 | 330 | 284 | 290 | 296 | 308 |
| 51 | 337 | 288.5 | 294.5 | 300.5 | 312.5 |
| 52 | 345 | 293 | 299 | 305 | 317 |

All measurements in mm.

The required width can be determined from the table according to the wearer's foot length. The following table shows the corresponding uvex article number for the different widths:

► For any questions or queries, please contact uvex customer service at safety@uvex.de.

| uvex article number | Width | Certification | Size range |
|---------------------|---------------|----------------------------------|--------------------|
| XXXX.1 | 10 | EN ISO 20345: 2011 S1 P or S3 | depending on model |
| XXXX.2 | 11 (standard) | | |
| XXXX.3 | 12 | | |
| XXXX.4 | 14 | | |
| XXXX.7 | 10 | EN ISO 20345: 2011 S1 or S2 | depending on model |
| XXXX.8 | 11 (standard) | | |
| XXXX.9 | 12 | | |
| XXXX.0 | 14 | | |



uvex size advisor app

When choosing safety shoes, it is especially important to choose the right size in order to benefit fully from their protective function. In addition, only a perfect fit ensures lasting wearer comfort. However, size specifications may vary depending on the manufacturer. With the uvex size advisor app you can determine the right uvex shoe size and width to ensure the perfect fit and most comfortable shoe for your working day.



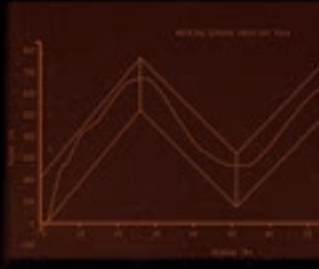

The new uvex 1 G2.

Shock-absorbing. Stabilising. Energy-returning.

Science. Not fiction — uvex i-PUREnrj

The future is full of energy with the pioneering uvex 1 G2 safety shoes. uvex's innovative new polyurethane sole technology – uvex i-PUREnrj – returns the landing energy over the entire sole unit back to the wearer and redefines shock absorption and stability. This makes every day full of energy, with noticeably greater comfort and significantly lower fatigue in the feet.

- 100% higher energy absorption than that specified by the EN ISO 20345 standard.
- 66% energy recovery in the heel.*
- 59% energy recovery in the forefoot.*
- 29% higher shock absorption than standard polyurethane soles after 1000 km of use.*
- 21% less perceived fatigue than with standard polyurethane soles after a working day.

You can find more information at www.uvex-safety.com/uvex1G2



*Test report no. L190714889 CTC Lyon, 22.08.2019

Safety Footwear

uvex 1 G2



68467
68468
68469
68460



68497
68498
68499
68490



uvex 1 G2 Perforated shoe S1 SRC · Shoe S2 SRC

General features:

- ultra-lightweight perforated S1 safety shoe and S2 safety shoe
- made from synthetic materials, making it suitable for people allergic to chrome
- all sole materials are free of silicone, plasticisers and other paint wetting impairment substances
- elastic laces for quick, individual adjustment, normal laces also provided

Protection features:

- new, innovative uvex i-PUREnrj sole technology with the highest level of shock-absorbing properties at the forefoot and at the heel, excellent rebound over the entire midsole and optimal stability thanks to the foam heel basket
- meets the ESD specification with volume resistance under 35 megaohms
- new wider 100% metal-free uvex xenova® safety toe cap for more toe room and optimum fit – compact design, anatomical shape, good lateral stability and no thermal conductivity
- ergonomically designed outsole incorporates the latest biomechanical research, consisting of two layers of uvex i-PUREnrj polyurethane with excellent slip resistance. The tread is particularly suited to industrial floor surfaces

Comfort features:

- outstanding wearer comfort thanks to a newly developed last and climate-optimised, breathable materials
- virtually seam-free upper in high-tech microvelour to eliminate pressure points, perforated on the S1 shoe, hydrophobic on the S2 shoe
- removable antistatic comfortable insole with a moisture transport system, additional shock absorption around the heel and forefoot and excellent support for the arch
- soft padding on the tongue (S1 shoe) or dust tongue (S2 shoe) and collar
- sizes 35 to 40 have been produced using a women's last

Areas of application:

- light applications



| uvex 1 G2 | Perforated Shoe S1 SRC | | | | Shoe S2 SRC | | | |
|-------------------|--------------------------|----------|----------|----------|--------------------------|----------|----------|----------|
| Art. no. | 68467 | 68468 | 68469 | 68460 | 68497 | 68498 | 68499 | 68490 |
| Width | 10 | 11 | 12 | 14 | 10 | 11 | 12 | 14 |
| Standard | EN ISO 20345:2011 S1 SRC | | | | EN ISO 20345:2011 S2 SRC | | | |
| Upper | microvelour | | | | microvelour | | | |
| Lining | distance mesh lining | | | | distance mesh lining | | | |
| Sizes | 35 to 52 | 35 to 52 | 35 to 52 | 35 to 52 | 35 to 52 | 35 to 52 | 35 to 52 | 35 to 52 |
| Order unit | PR | PR | PR | PR | PR | PR | PR | PR |

uvex



Video



Winners at work – uvex 1 sport



Designed for Individuals



Sporty look.

Sporty design meets sophisticated functionality: The uvex 1 sport is both youthful and stylish combined with first-class wearer comfort, thanks to its lightweight design, climate optimised high-tech materials and ergonomically shaped outsole.

uvex 1 sport – the ideal companion for daily working life and more.

High breathability.

The breathable mesh upper ensures optimised climate control. The sporty look of the uvex 1 sport is contributing to the increased acceptance of wearing safety footwear.

Lightweight and ergonomic design.

uvex 1 sport sole

- ergonomically designed outsole comprising dual-density polyurethane for light applications
- extremely comfortable underfoot
- suitable for general use on almost all surfaces
- excellent anti-slip properties (SRC)
- abrasion-resistant
- meets the ESD specification with volume resistance < 35 megaohms
- free of paint wetting impairment substances

Website



Now also available as occupational shoes on page 275.

Safety Footwear

uvex 1 sport



65971 65977
65972 65978
65973 65979
65974 65970



65991 65997
65992 65998
65993 65999
65994 65990



uvex 1 sport · Shoe S1 SRC/S1 P SRC

General features:

- modern, ultra lightweight and flexible S1 and S1 P safety shoes
- suitable for people allergic to chrome as it's made from synthetic materials
- all sole materials are free of silicones, plasticisers and other paint wetting impairment substances

Protection features:

- meets the ESD specification with volume resistance under 35 megaohms
- 100% metal-free uvex xenova® toe cap – compact design, anatomical shape, good lateral stability, no thermal conductivity
- ergonomically designed outsole made from dual density polyurethane with excellent slip resistance
- penetration-resistant, non-metallic midsole in accordance with the latest safety standards, does not restrict flexibility of the shoe (Shoe S1 P only)

Comfort features:

- outstanding wearer comfort thanks to a newly developed last and climate-optimised, breathable materials
- virtually seam-free construction made from high-tech materials to eliminate pressure points
- removable antistatic comfortable insole, with a moisture transport system and additional shock absorption around the heel and forefoot
- soft padding on collar and tongue
- sizes 35 to 40 have been produced using a women's last

Areas of application:

- light applications

| uvex 1 sport | Shoe S1 P SRC | | | | Shoe S1 SRC | | | |
|-------------------|----------------------------|----------|----------|----------|--------------------------|----------|----------|----------|
| Art. no. | 65971 | 65972 | 65973 | 65974 | 65977 | 65978 | 65979 | 65970 |
| Width | 10 | 11 | 12 | 14 | 10 | 11 | 12 | 14 |
| Standard | EN ISO 20345:2011 S1 P SRC | | | | EN ISO 20345:2011 S1 SRC | | | |
| Upper | textile | | | | | | | |
| Lining | distance mesh lining | | | | | | | |
| Size | 35 to 43 | 35 to 43 | 35 to 43 | 35 to 43 | 35 to 43 | 35 to 43 | 35 to 43 | 35 to 43 |
| Order unit | PR | PR | PR | PR | PR | PR | PR | PR |

| uvex 1 sport | Shoe S1 P SRC | | | | Shoe S1 SRC | | | |
|-------------------|----------------------------|----------|----------|----------|--------------------------|----------|----------|----------|
| Art. no. | 65991 | 65992 | 65993 | 65994 | 65997 | 65998 | 65999 | 65990 |
| Width | 10 | 11 | 12 | 14 | 10 | 11 | 12 | 14 |
| Standard | EN ISO 20345:2011 S1 P SRC | | | | EN ISO 20345:2011 S1 SRC | | | |
| Upper | textile | | | | | | | |
| Lining | distance mesh lining | | | | | | | |
| Size | 35 to 52 | 35 to 52 | 35 to 52 | 35 to 52 | 35 to 52 | 35 to 52 | 35 to 52 | 35 to 52 |
| Order unit | PR | PR | PR | PR | PR | PR | PR | PR |

Safety Footwear

uvex 1 sport



65961
65962
65963
65964



65987
65988
65989
65980



65941 65947
65942 65948
65943 65949
65944 65940



uvex 1 sport · Shoe S1 SRC/S3 SRC/S1 P SRC

General features:

- modern, ultra lightweight and flexible S1 and S3 safety shoes
- suitable for people allergic to chrome as it's made from synthetic materials
- all sole materials are free of silicones, plasticisers and other paint wetting impairment substances

Protection features:

- meets the ESD specification with volume resistance less than 35 megaohms
- 100% metal-free uvex xenova® toe cap – compact design, anatomical shape, good lateral stability, no thermal conductivity
- ergonomically designed outsole comprising dual-density polyurethane with excellent slip resistance
- penetration-resistant, non-metallic midsole in accordance with the latest safety standards, does not restrict flexibility of the shoe (S1 P and S3 shoes only)

Comfort features:

- outstanding wearer comfort thanks to a newly developed last and climate-optimised, breathable materials
- virtually seam-free construction made from high-tech materials to eliminate pressure points
- removable antistatic comfortable insole, with a moisture transport system and additional shock absorption around the heel and forefoot
- soft padding on collar and tongue
- sizes 35 to 40 have been produced using a women's last

Areas of application:

- light applications

| uvex 1 sport | Shoe S3 SRC | | | | Shoe S1 SRC | | | |
|--------------|--------------------------|----------|----------|----------|--------------------------|----------|----------|----------|
| Art. no. | 65961 | 65962 | 65963 | 65964 | 65987 | 65988 | 65989 | 65980 |
| Width | 10 | 11 | 12 | 14 | 10 | 11 | 12 | 14 |
| Standard | EN ISO 20345:2011 S3 SRC | | | | EN ISO 20345:2011 S1 SRC | | | |
| Upper | microvelour | | | | textile | | | |
| Lining | distance mesh lining | | | | distance mesh lining | | | |
| Sizes | 35 to 52 | 35 to 52 | 35 to 52 | 35 to 52 | 35 to 52 | 35 to 52 | 35 to 52 | 35 to 52 |
| Order unit | PR | PR | PR | PR | PR | PR | PR | PR |

| uvex 1 sport | Shoe S1 P SRC | | | | Shoe S1 SRC | | | |
|--------------|----------------------------|----------|----------|----------|--------------------------|----------|----------|----------|
| Art. no. | 65941 | 65942 | 65943 | 65944 | 65947 | 65948 | 65949 | 65940 |
| Width | 10 | 11 | 12 | 14 | 10 | 11 | 12 | 14 |
| Standard | EN ISO 20345:2011 S1 P SRC | | | | EN ISO 20345:2011 S1 SRC | | | |
| Upper | textile | | | | textile | | | |
| Lining | distance mesh lining | | | | distance mesh lining | | | |
| Sizes | 35 to 52 | 35 to 52 | 35 to 52 | 35 to 52 | 35 to 52 | 35 to 52 | 35 to 52 | 35 to 52 |
| Order unit | PR | PR | PR | PR | PR | PR | PR | PR |



Safety Footwear

uvex 1 sport



65901
65902
65903
65904



65921
65922
65923
65924



uvex 1 sport · Shoe S1 P SRC/S3 SRC

General features:

- modern, ultra lightweight and flexible S1 and S1 P safety shoes
- suitable for people allergic to chrome as it's made from synthetic materials
- all sole materials are free of silicones, plasticisers and other paint wetting impairment substances

Protection features:

- meets the ESD specification with volume resistance under 35 megaohms
- 100% metal-free uvex xenova® toe cap – compact design, anatomical shape, good lateral stability, no thermal conductivity
- ergonomically designed outsole made from dual density polyurethane with excellent slip resistance
- penetration-resistant, non-metallic midsole in accordance with the latest safety standards, does not restrict flexibility of the shoe

Comfort features:

- outstanding wearer comfort thanks to a newly developed last and climate-optimised, breathable materials
- virtually seam-free construction made from high-tech materials to eliminate pressure points
- removable antistatic comfortable insole, with a moisture transport system and additional shock absorption around the heel and forefoot
- soft padding on collar and tongue
- sizes 35 to 40 have been produced using a women's last

Areas of application:

- light applications

| uvex 1 sport | Shoe S1 P SRC | | | | Shoe S3 SRC | | | |
|-------------------|----------------------------|----------|----------|----------|--------------------------|----------|----------|----------|
| Art. no. | 65901 | 65902 | 65903 | 65904 | 65921 | 65922 | 65923 | 65924 |
| Width | 10 | 11 | 12 | 14 | 10 | 11 | 12 | 14 |
| Standard | EN ISO 20345:2011 S1 P SRC | | | | EN ISO 20345:2011 S3 SRC | | | |
| Upper | textile | | | | microvelour | | | |
| Lining | distance mesh lining | | | | distance mesh lining | | | |
| Size | 35 to 52 | 35 to 52 | 35 to 52 | 35 to 52 | 35 to 52 | 35 to 52 | 35 to 52 | 35 to 52 |
| Order unit | PR | PR | PR | PR | PR | PR | PR | PR |

Occupational shoes

uvex 1 sport NC



65937
65938
65939



65957
65958
65959



climazone

uvex 1 sport NC - Shoe O1 FO SRC

General features:

- modern, ultra-lightweight and flexible O1 occupational shoes without toe cap
- suitable for people allergic to chrome as it's made from synthetic materials
- all sole materials are free of silicones, plasticisers and other paint wetting impairment substances

Protection features:

- meets the ESD specification with volume resistance less than 35 megaohms
- ergonomically designed outsole comprising dual-density polyurethane with excellent slip resistance

Comfort features:

- outstanding wearer comfort thanks to a newly developed last and climate-optimised, breathable materials
- virtually seam-free construction made from high-tech materials to eliminate pressure points
- removable antistatic comfortable insole, with a moisture transport system and additional shock absorption around the heel and forefoot
- soft padding on collar and tongue
- sizes 35 to 40 have been produced using a women's last

Areas of application:

- light applications



| uvex 1 sport NC | Shoe O1 FO SRC | | | Shoe O1 FO SRC | | |
|-------------------|-----------------------------|----------|----------|-----------------------------|----------|----------|
| Art. no. | 65937 | 65938 | 65939 | 65957 | 65958 | 65959 |
| Width | 10 | 11 | 12 | 10 | 11 | 12 |
| Standard | EN ISO 20347:2012 O1 FO SRC | | | EN ISO 20347:2012 O1 FO SRC | | |
| Upper | textile | | | textile | | |
| Lining | distance mesh lining | | | distance mesh lining | | |
| Sizes | 35 to 52 | 35 to 52 | 35 to 52 | 35 to 52 | 35 to 52 | 35 to 52 |
| Order unit | PR | PR | PR | PR | PR | PR |

uvex 1 – redefining performance

Next Level Equipment



Outstanding flexibility. Optimum wearer comfort.

The ergonomic design of the outsole supports the natural movement and flexibility of the feet.

High abrasion-resistant TPU sections ensure secure stepping and rolling of the foot, which helps prevent accidents.

Ideal shape around the joints for optimal torsion and good flexibility. Self-cleaning tread optimised for slip resistance (SRC marking).



Jointed insert for securely climbing ladders.

Pivot point reduces pressure on joints when twisting and turning.



Lightweight construction. Reduced fatigue.

Omit but don't miss out. A lower weight reduces strain on the body and reduces the risk of injury and wear. This is evident in the low weight design principle of the uvex 1 safety shoes. As the lightest uvex shoe in its class, the uvex 1 is approximately 100g lighter than uvex's bestseller the uvex motion style.



100% more shock absorption. Comfort in 3 dimensions.

The uvex 1 multilayer shock absorption system comprising a double-layered uvex 1 PU outsole and comfort insole with optimum shock absorption in the heel and the front of the foot helps protect the musculoskeletal system. The energy absorption in the heel is twice that required by EN ISO 20345. Pure walking comfort.



Outstanding stability. Reliable support and safety.

Consistent stability is essential for secure, sure-footedness and accident-free working. The visible external heel basket which is integrated into the sole ensures stability and offers additional side impact protection. The 'x-tended' support model offers additional sideways support and enhanced protection against ankle twisting and impact. Both sole versions securely enclose the foot, without limiting flexibility.



uvex monoskin shaft design. Pressure-free, comfortable fit.

The completely metal-free uvex monoskin upper shaft made from high-tech microfibre ensures outstanding wearer comfort without pressure points and the virtually seamless construction offers extended product life.

The uvex 1 safety footwear supports the natural movement of the whole body, reducing pressure and strain while maximising comfort. Continuous product development is carried out on the basis of the latest physiological research and technology, ensuring maximum performance with quantifiable benefits.



100% metal-free



Orthopaedic solutions according to German DGUV 112-191 and Austrian ÖNORM Z1259

climazone

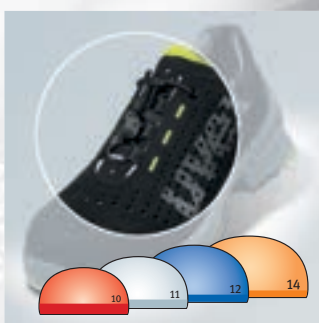

Anatomically designed for optimum comfort and fit.

- flexible multiple width system for reliable support and comfort
- the flexible uvex multiple width system with widths 10-14** provides optimum fit
- individually adjustable quick-lace system (IAS)**
- anatomically designed toe cap for total safety
- use of a specially designed women's last for the uvex 1 models in sizes 35 to 40

uvex climazone standard. Temperature and climate control.

Large perforations, ultra breathable high-tech-micro velour upper and distance mesh lining material together with a comfortable insole with moisture control system prevents the build-up of heat and reduces sweat.

* Formerly known as German BGR 191 ** only for specific models



Safety Footwear

uvex 1



85427
85428
85429
85420



85437
85438
85439
85430



uvex 1 • Sandal S1 SRC • Perforated shoe S1 SRC

General features:

- ultra low weight, versatile S1 safety sandal and perforated safety shoe
- made from synthetic materials, so suitable for people allergic to chrome
- all sole materials are free of silicones, plasticisers and other paint wetting impairment substances
- two adjustable hook-and-loop straps (sandal) or elastic laces for quick, individual adjustment; normal laces also provided (shoe)

Protection features:

- meets the ESD specification with volume resistance under 35 megaohms
- 100% metal-free uvex xenova® toe cap – compact design, anatomical shape, good lateral stability, no thermal conductivity
- ergonomically designed outsole made from dual density polyurethane with excellent slip resistance

Comfort features:

- outstanding wearer comfort results from a newly developed last and climate-optimised, breathable materials
- virtually seam-free construction made from high-tech microvelour material to eliminate pressure points
- removable antistatic comfortable insole, with a moisture transport system and additional shock absorption around the heel and forefoot
- soft padding on collar and tongue
- sizes 35 to 40 have been produced using a women's last

Areas of application:

- light applications

| uvex 1 Sandal S1 SRC | | | | |
|----------------------|--------------------------|----------|----------|----------|
| Art. no. | 85427 | 85428 | 85429 | 85420 |
| Width | 10 | 11 | 12 | 14 |
| Standard | EN ISO 20345:2011 S1 SRC | | | |
| Upper | microvelour | | | |
| Lining | distance mesh lining | | | |
| Sizes | 35 to 52 | 35 to 52 | 35 to 52 | 35 to 52 |
| Order unit | PR | PR | PR | PR |

| uvex 1 Perforated shoe S1 SRC | | | | |
|-------------------------------|--------------------------|----------|----------|----------|
| Art. no. | 85437 | 85438 | 85439 | 85430 |
| Width | 10 | 11 | 12 | 14 |
| Standard | EN ISO 20345:2011 S1 SRC | | | |
| Upper | microvelour | | | |
| Lining | distance mesh lining | | | |
| Sizes | 35 to 52 | 35 to 52 | 35 to 52 | 35 to 52 |
| Order unit | PR | PR | PR | PR |

Safety Footwear

uvex 1



85447
85448
85449
85440



85457
85458
85459
85450



uvex 1 • Shoe S2 SRC • Lace-up boot S2 SRC

General features:

- ultra low weight, versatile S2 safety shoe/boot
- made from synthetic materials, so suitable for people allergic to chrome
- all sole materials are free of silicones, plasticisers and other paint wetting impairment substances
- elastic laces for quick, individual adjustment, normal laces also provided (shoe)

Protection features:

- meets the ESD specification with volume resistance under 35 megaohms
- 100% metal-free uvex xenova® toe cap – compact design, anatomical shape, good lateral stability, no thermal conductivity
- ergonomically designed outsole made from dual density polyurethane with excellent slip resistance

Comfort features:

- outstanding wearer comfort results from a newly developed last and climate-optimised, breathable materials
- virtually seam-free construction made from high-tech microvelour material to eliminate pressure points
- removable antistatic comfortable insole, with a moisture transport system and additional shock absorption around the heel and forefoot
- soft padding on collar and dust tongue
- sizes 35 to 40 have been produced using a women's last

Areas of application:

- light applications



| uvex 1 Shoe S2 SRC | | | | |
|--------------------|--------------------------|----------|----------|----------|
| Art. no. | 85447 | 85448 | 85449 | 85440 |
| Width | 10 | 11 | 12 | 14 |
| Standard | EN ISO 20345:2011 S2 SRC | | | |
| Upper | microvelour | | | |
| Lining | distance mesh lining | | | |
| Sizes | 35 to 52 | 35 to 52 | 35 to 52 | 35 to 52 |
| Order unit | PR | PR | PR | PR |

| uvex 1 Lace-up boot S2 SRC | | | | |
|----------------------------|--------------------------|----------|----------|----------|
| Art. no. | 85457 | 85458 | 85459 | 85450 |
| Width | 10 | 11 | 12 | 14 |
| Standard | EN ISO 20345:2011 S2 SRC | | | |
| Upper | microvelour | | | |
| Lining | distance mesh lining | | | |
| Sizes | 35 to 52 | 35 to 52 | 35 to 52 | 35 to 52 |
| Order unit | PR | PR | PR | PR |

Safety Footwear

uvex 1



65657
65658
65659



65667
65668
65669



uvex 1 - Perforated shoe S1 SRC - Shoe S2 SRC

General features:

- ultra-lightweight, versatile and perforated S1 safety shoe and S2 safety shoe
- made from synthetic materials, so suitable for people allergic to chrome
- all sole materials are free of silicones, plasticisers and other paint wetting impairment substances
- Boa® Fit System (consisting of a micro-adjustable dial, super-strong lightweight laces and low friction lace guides) engineered to optimise fit and provide precision, adaptability, and control

Protection features:

- meets the ESD specification with volume resistance under 35 megaohms
- 100% metal-free uvex xenova® toe cap – compact design, anatomical shape, good lateral stability, no thermal conductivity
- ergonomically designed outsole made from dual density polyurethane with excellent slip resistance

Comfort features:

- outstanding wearer comfort results from a newly developed last and climate-optimised, breathable materials with perforation (S1 model)
- virtually seam-free construction made from high-tech microvelour material to eliminate pressure points
- removable antistatic comfortable insole, with a moisture transport system and additional shock absorption around the heel and forefoot
- soft padding on collar and tongue
- sizes 35 to 40 have been produced using a women's last

Areas of application:

- light applications

| uvex 1 | Perforated shoe S1 SRC | | | Shoe S2 SRC | | |
|-------------------|--------------------------|----------|----------|--------------------------|----------|----------|
| Art. no. | 65657 | 65658 | 65659 | 65667 | 65668 | 65669 |
| Width | 10 | 11 | 12 | 10 | 11 | 12 |
| Standard | EN ISO 20345:2011 S1 SRC | | | EN ISO 20345:2011 S2 SRC | | |
| Upper | microvelour | | | microvelour | | |
| Lining | distance mesh lining | | | distance mesh lining | | |
| Sizes | 35 to 52 | 35 to 52 | 35 to 52 | 35 to 52 | 35 to 52 | 35 to 52 |
| Order unit | PR | PR | PR | PR | PR | PR |

Safety Footwear

uvex 1



85467
85468
85469



85477
85478
85479



uvex 1 · Perforated shoe S1 SRC · Perforated lace-up boot S1 SRC

General features:

- ultra low weight and versatile perforated S1 safety shoe or boot
- made from synthetic materials, so suitable for people allergic to chrome
- all sole materials are free of silicones, plasticisers and other paint wetting impairment substances
- elastic laces for quick, individual adjustment, normal laces also provided (shoe)

Protection features:

- meets the ESD specification with volume resistance under 35 megaohms
- 100% metal-free uvex xenova® toe cap – compact design, anatomical shape, good lateral stability, no thermal conductivity
- ergonomically designed outsole made from dual density polyurethane with excellent slip resistance

Comfort features:

- outstanding wearer comfort results from a newly developed last and climate-optimised, breathable materials with perforation
- virtually seam-free construction made from high-tech microvelour material to eliminate pressure points
- removable antistatic comfortable insole, with a moisture transport system and additional shock absorption around the heel and forefoot
- soft padding on collar and tongue
- sizes 35 to 40 have been produced using a women's last

Areas of application:

- light applications



| uvex 1 | Perforated shoe S1 SRC | | | Perforated lace-up boot S1 SRC | | |
|-------------------|--------------------------|----------|----------|--------------------------------|----------|----------|
| Art. no. | 85467 | 85468 | 85469 | 85477 | 85478 | 85479 |
| Width | 10 | 11 | 12 | 10 | 11 | 12 |
| Standard | EN ISO 20345:2011 S1 SRC | | | EN ISO 20345:2011 S1 SRC | | |
| Upper | microvelour | | | microvelour | | |
| Lining | distance mesh lining | | | distance mesh lining | | |
| Sizes | 35 to 52 | 35 to 52 | 35 to 52 | 35 to 52 | 35 to 52 | 35 to 52 |
| Order unit | PR | PR | PR | PR | PR | PR |

Safety Footwear

uvex 1



85307
85308
85309



85347
85348
85349
85340



climazone

uvex 1 • Sandal S1 SRC • Shoe S2 SRC

General features:

- ultra low weight, versatile S1 safety sandal or S2 safety shoe
- made from synthetic materials, so suitable for people allergic to chrome
- all sole materials are free of silicones, plasticisers and other paint wetting impairment substances
- two adjustable hook-and-loop straps (sandal)

Protection features:

- meets the ESD specification with volume resistance under 35 megaohms
- 100% metal-free uvex xenova® toe cap – compact design, anatomical shape, good lateral stability, no thermal conductivity
- ergonomically designed outsole made from dual density polyurethane with excellent slip resistance

Comfort features:

- outstanding wearer comfort results from a newly developed last and climate-optimised, breathable materials with perforation (sandals)
- virtually seam-free construction made from high-tech microvelour material to eliminate pressure points
- removable antistatic comfortable insole, with a moisture transport system and additional shock absorption around the heel and forefoot
- soft padding on collar and tongue (sandal) or collar and dust tongue (shoe)
- sizes 35 to 40 have been produced using a women's last

Areas of application:

- light applications

| uvex 1 Sandal S1 SRC | | | |
|----------------------|--------------------------|----------|----------|
| Art. no. | 85307 | 85308 | 85309 |
| Width | 10 | 11 | 12 |
| Standard | EN ISO 20345:2011 S1 SRC | | |
| Upper | microvelour | | |
| Lining | distance mesh lining | | |
| Sizes | 35 to 52 | 35 to 52 | 35 to 52 |
| Order unit | PR | PR | PR |

| uvex 1 Shoe S2 SRC | | | | |
|--------------------|--------------------------|----------|----------|----------|
| Art. no. | 85347 | 85348 | 85349 | 85340 |
| Width | 10 | 11 | 12 | 14 |
| Standard | EN ISO 20345:2011 S2 SRC | | | |
| Upper | microvelour | | | |
| Lining | distance mesh lining | | | |
| Sizes | 35 to 52 | 35 to 52 | 35 to 52 | 35 to 52 |
| Order unit | PR | PR | PR | PR |

Safety Footwear

uvex 1



85317
85318
85319
85310



85327
85328
85329
85320



climazone

uvex 1 • Perforated shoe S1 SRC • Perforated lace-up boot S1 SRC

General features:

- ultra low weight and versatile perforated S1 safety shoe or boot
- made from synthetic materials, so suitable for people allergic to chrome
- all sole materials are free of silicones, plasticisers and other paint wetting impairment substances

Protection features:

- meets the ESD specification with volume resistance under 35 megaohms
- 100% metal-free uvex xenova® toe cap – compact design, anatomical shape, good lateral stability, no thermal conductivity
- ergonomically designed outsole made from dual density polyurethane with excellent slip resistance

Comfort features:

- outstanding wearer comfort results from a newly developed last and climate-optimised, breathable materials with perforation
- virtually seam-free construction made from high-tech microvelour material to eliminate pressure points
- removable antistatic comfortable insole, with a moisture transport system and additional shock absorption around the heel and forefoot
- soft padding on collar and tongue
- sizes 35 to 40 have been produced using a women's last

Areas of application:

- light applications



| uvex 1 Perforated shoe S1 SRC | | | | |
|-------------------------------|--------------------------|----------|----------|----------|
| Art. no. | 85317 | 85318 | 85319 | 85310 |
| Width | 10 | 11 | 12 | 14 |
| Standard | EN ISO 20345:2011 S1 SRC | | | |
| Upper | microvelour | | | |
| Lining | distance mesh lining | | | |
| Sizes | 35 to 52 | 35 to 52 | 35 to 52 | 35 to 52 |
| Order unit | PR | PR | PR | PR |

| uvex 1 Perforated lace-up boot S1 SRC | | | | |
|---------------------------------------|--------------------------|----------|----------|----------|
| Art. no. | 85327 | 85328 | 85329 | 85320 |
| Width | 10 | 11 | 12 | 14 |
| Standard | EN ISO 20345:2011 S1 SRC | | | |
| Upper | microvelour | | | |
| Lining | distance mesh lining | | | |
| Sizes | 35 to 52 | 35 to 52 | 35 to 52 | 35 to 52 |
| Order unit | PR | PR | PR | PR |

Safety Footwear

uvex 1



65507
65508
65509
65500

65567
65568
65569
65560

65537
65538
65539
65530



climazone

uvex 1 · Sandal S1 SRC · Perforated Shoe S1 SRC · Perforated lace-up boot S1 SRC

General features:

- ultra-lightweight, versatile S1 safety sandal and perforated S1 safety shoe/boot
- made from synthetic materials, so suitable for people allergic to chrome
- all sole materials are free of silicones, plasticisers and other paint wetting impairment substances
- two adjustable hook-and-loop straps (sandal) or elastic laces for quick, individual adjustment; normal laces also provided (shoe)

Protection features:

- meets the ESD specification with volume resistance under 35 megaohms
- 100% metal-free uvex xenova® toe cap – compact design, anatomical shape, good lateral stability, no thermal conductivity
- ergonomically designed outsole made from dual density polyurethane with excellent slip resistance

Comfort features:

- outstanding wearer comfort results from a newly developed last and climate-optimised, breathable materials with perforation
- virtually seam-free construction made from high-tech microvelour material to eliminate pressure points
- removable antistatic comfortable insole, with a moisture transport system and additional shock absorption around the heel and forefoot
- soft padding on collar and tongue
- sizes 35 to 40 have been produced using a women's last

Areas of application:

- light applications

| uvex 1 | Sandal S1 SRC | | | | Perforated Shoe S1 SRC | | | |
|-------------------|---------------------------|----------|----------|----------|---------------------------|----------|----------|----------|
| Art. no. | 65507 | 65508 | 65509 | 65500 | 65567 | 65568 | 65569 | 65560 |
| Width | 10 | 11 | 12 | 14 | 10 | 11 | 12 | 14 |
| Standard | EN ISO 20345: 2011 S1 SRC | | | | EN ISO 20345: 2011 S1 SRC | | | |
| Upper | microvelour | | | | microvelour | | | |
| Lining | distance mesh lining | | | | distance mesh lining | | | |
| Sizes | 35 to 52 | 35 to 52 | 35 to 52 | 35 to 52 | 35 to 52 | 35 to 52 | 35 to 52 | 35 to 52 |
| Order unit | PR | PR | PR | PR | PR | PR | PR | PR |

| uvex 1 | Perforated Lace-up boot S1 SRC | | | |
|-------------------|--------------------------------|----------|----------|----------|
| Art. no. | 65537 | 65538 | 65539 | 65530 |
| Width | 10 | 11 | 12 | 14 |
| Standard | EN ISO 20345: 2011 S1 SRC | | | |
| Upper | microvelour | | | |
| Lining | distance mesh lining | | | |
| Sizes | 35 to 52 | 35 to 52 | 35 to 52 | 35 to 52 |
| Order unit | PR | PR | PR | PR |

Safety Footwear

uvex 1



65577
65578
65579
65570



65547
65548
65549
65540



climazone

uvex 1 · Shoe S2 SRC · Lace-up boot S2 SRC

General features:

- ultra low weight, versatile S2 safety shoe/boot
- made from synthetic materials, so suitable for people allergic to chrome
- all sole materials are free of silicone, plasticisers and other paint wetting impairment substances
- elastic laces with quick release for individual adjustment, standard laces included (shoe)

Protection features:

- meets the ESD specification with volume resistance under 35 megaohms
- 100% metal-free uvex xenova® toe cap – compact design, anatomical shape, good lateral stability, no thermal conductivity
- ergonomically designed outsole made from dual density polyurethane with excellent slip resistance

Comfort features:

- outstanding wearer comfort thanks to a newly developed last and climate-optimised, breathable materials
- virtually seam-free construction from high-tech microvelour material to eliminate pressure points
- removable antistatic comfortable insole, with a moisture transport system and additional shock absorption around the heel and forefoot
- soft padding on collar and dust tongue
- sizes 35 to 40 have been produced using a women's last

Areas of application:

- light applications



| uvex 1 Shoe S2 SRC | | | | |
|--------------------|--------------------------|----------|----------|----------|
| Art. no. | 65577 | 65578 | 65579 | 65570 |
| Width | 10 | 11 | 12 | 14 |
| Standard | EN ISO 20345:2011 S2 SRC | | | |
| Upper | microvelour | | | |
| Lining | distance mesh lining | | | |
| Sizes | 35 to 52 | 35 to 52 | 35 to 52 | 35 to 52 |
| Order unit | PR | PR | PR | PR |

| uvex 1 Lace-up boot S2 SRC | | | | |
|----------------------------|--------------------------|----------|----------|----------|
| Art. no. | 65547 | 65548 | 65549 | 65540 |
| Width | 10 | 11 | 12 | 14 |
| Standard | EN ISO 20345:2011 S2 SRC | | | |
| Upper | microvelour | | | |
| Lining | distance mesh lining | | | |
| Sizes | 35 to 52 | 35 to 52 | 35 to 52 | 35 to 52 |
| Order unit | PR | PR | PR | PR |

Safety Footwear

uvex 1 x-tended support



85127
85128
85129



85117
85118
85119

| | | |
|--|---|---|
|  Focus Open 2013 Silver |  reddot design award winner 2013 |  German Design Award WINNER 2015 |
|--|---|---|



uvex 1 x-tended support · Perforated Shoe S1 SRC

General features:

- ultra low weight and versatile perforated S1 safety shoe
- made from synthetic materials, so suitable for people allergic to chrome
- all sole materials are free of silicones, plasticisers and other paint wetting impairment substances
- elastic laces for quick, individual adjustment, normal laces also provided

Protection features:

- meets the ESD specification with volume resistance under 35 megaohms
- 100% metal-free uvex xenova® toe cap – compact design, anatomical shape, good lateral stability, no thermal conductivity
- ergonomically designed outsole made from dual density polyurethane with excellent slip resistance
- ‘x-tended’ support: medial and lateral heel support for the foot with specially designed side frame – provides additional protection from ankle twisting, stabilises and guides the foot while providing impact protection
- penetration-resistant, non-metallic midsole in accordance with the latest safety standards, does not restrict flexibility of the shoe

Comfort features:

- outstanding wearer comfort results from a newly developed last and climate-optimised, breathable materials with perforation
- virtually seam-free construction made from high-tech microvelour material to eliminate pressure points
- removable antistatic comfortable insole, with a moisture transport system and additional shock absorption around the heel and forefoot
- soft padding on collar and tongue
- sizes 35 to 40 have been produced using a women’s last

Areas of application:

- light applications

| uvex 1 x-tended support | Perforated Shoe S1 SRC | | | Perforated Shoe S1 SRC | | |
|-------------------------|--------------------------|----------|----------|--------------------------|----------|----------|
| Art. no. | 85127 | 85128 | 85129 | 85117 | 85118 | 85119 |
| Width | 10 | 11 | 12 | 10 | 11 | 12 |
| Standard | EN ISO 20345:2011 S1 SRC | | | EN ISO 20345:2011 S1 SRC | | |
| Upper | microvelour | | | microvelour | | |
| Lining | distance mesh lining | | | distance mesh lining | | |
| Sizes | 35 to 52 | 35 to 52 | 35 to 52 | 35 to 52 | 35 to 52 | 35 to 52 |
| Order unit | PR | PR | PR | PR | PR | PR |

Safety Footwear

uvex 1 x-tended support



85141
85142
85143



85191
85192
85193



uvex 1 x-tended support · Perforated Shoe S1 P SRC

General features:

- ultra lightweight and versatile perforated S1 P safety shoe
- made from synthetic materials, so suitable for people allergic to chrome
- all sole materials are free of silicones, plasticisers and other paint wetting impairment substances
- foamed polyurethane scuffcap helps increase product life of upper
- elastic laces for quick, individual adjustment, normal laces also provided

Protection features:

- meets the ESD specification with volume resistance under 35 meg-ohms
- 100% metal-free uvex xenova® toe cap – compact design, anatomical shape, good lateral stability, no thermal conductivity
- ergonomically designed outsole made from dual density polyurethane with excellent slip resistance
- 'x-tended' support: medial and lateral heel support for the foot with specially designed side frame – provides additional protection from ankle twisting, stabilises and guides the foot while providing impact protection
- penetration-resistant, non-metallic midsole in accordance with the latest safety standards, does not restrict flexibility of the shoe

Comfort features:

- outstanding wearer comfort results from a newly developed last and climate-optimised, breathable materials with perforation
- virtually seam-free construction made from high-tech microvelour material to eliminate pressure points
- removable antistatic comfortable insole, with a moisture transport system and additional shock absorption around the heel and forefoot
- soft padding on collar and tongue
- sizes 35 to 40 have been produced using a women's last

Areas of application:

- light applications



| uvex 1 x-tended support | Perforated Shoe S1 P SRC | | | Perforated Shoe S1 P SRC | | |
|-------------------------|----------------------------|----------|----------|----------------------------|----------|----------|
| Art. no. | 85141 | 85142 | 85143 | 85191 | 85192 | 85193 |
| Width | 10 | 11 | 12 | 10 | 11 | 12 |
| Standard | EN ISO 20345:2011 S1 P SRC | | | EN ISO 20345:2011 S1 P SRC | | |
| Upper | microvelour | | | microvelour | | |
| Lining | distance mesh lining | | | distance mesh lining | | |
| Sizes | 35 to 52 | 35 to 52 | 35 to 52 | 35 to 52 | 35 to 52 | 35 to 52 |
| Order unit | PR | PR | PR | PR | PR | PR |

Safety Footwear

uvex 1 x-tended support



85361
85362
85363

85161
85162
85163

85171
85172
85173



uvex 1 x-tended support · Sandal S1 P SRC · Shoe S3 SRC · Lace-up boot S3 SRC

General features:

- ultra low weight, versatile S1 P safety sandal or S3 safety shoe/boot
- made from synthetic materials, so suitable for people allergic to chrome
- all sole materials are free of silicones, plasticisers and other paint wetting impairment substances
- foamed polyurethane scuffcap helps increase product life of upper
- two adjustable hook-and-loop straps (sandal)
- elastic laces for quick, individual adjustment, normal laces also provided (shoe)

Protection features:

- meets the ESD specification with volume resistance under 35 megaohms
- 100% metal-free uvex xenova® toe cap – compact design, anatomical shape, good lateral stability, no thermal conductivity
- ergonomically designed outsole made from dual density polyurethane with excellent slip resistance
- 'x-tended' support: medial and lateral heel support for the foot with specially designed side frame – provides additional protection from ankle twisting, stabilises and guides the foot while providing impact protection (shoe and boot)
- penetration-resistant, non-metallic midsole in accordance with the latest safety standards, does not restrict flexibility of the shoe

Comfort features:

- outstanding wearer comfort thanks to a newly developed last and climate-optimised, breathable materials with perforation (sandal)
- virtually seam-free construction made from high-tech microvelour material to eliminate pressure points
- removable antistatic comfortable insole, with a moisture transport system and additional shock absorption around the heel and forefoot
- soft padding on collar and tongue (sandal) or dust tongue
- sizes 35 to 40 have been produced using a women's last

Areas of application:

- light applications

| uvex 1 x-tended support | Sandal S1 P SRC | | | Shoe S3 SRC | | | Lace-up boot S3 SRC | | |
|-------------------------|-----------------------------|----------|----------|---------------------------|----------|----------|---------------------------|----------|----------|
| Art. no. | 85361 | 85362 | 85363 | 85161 | 85162 | 85163 | 85171 | 85172 | 85173 |
| Width | 10 | 11 | 12 | 10 | 11 | 12 | 10 | 11 | 12 |
| Standard | EN ISO 20345: 2011 S1 P SRC | | | EN ISO 20345: 2011 S3 SRC | | | EN ISO 20345: 2011 S3 SRC | | |
| Upper | microvelour | | | microvelour | | | microvelour | | |
| Lining | distance mesh lining | | | distance mesh lining | | | distance mesh lining | | |
| Sizes | 35 to 52 | 35 to 52 | 35 to 52 | 35 to 52 | 35 to 52 | 35 to 52 | 35 to 52 | 35 to 52 | 35 to 52 |
| Order unit | PR | PR | PR | PR | PR | PR | PR | PR | PR |

Safety Footwear

uvex 1 x-tended support



65681
65682
65683



65671
65672
65673



uvex 1 x-tended support · Perforated Shoe S1 P SRC · Shoe S3 SRC

General features:

- ultra-lightweight and versatile perforated S1 P safety shoe and S3 safety shoe
- made from synthetic materials, so suitable for people allergic to chrome
- all sole materials are free of silicones, plasticisers and other paint wetting impairment substances
- foamed polyurethane scuffcap helps increase product life of upper
- Boa® Fit System (consisting of a micro-adjustable dial, super-strong lightweight laces and low friction lace guides) engineered to optimise fit and provide precision, adaptability, and control

Protection features:

- meets the ESD specification with volume resistance under 35 megaohms
- 100% metal-free uvex xenova® toe cap – compact design, anatomical shape, good lateral stability, no thermal conductivity
- ergonomically designed outsole made from dual density polyurethane with excellent slip resistance
- 'x-tended' support: medial and lateral heel support for the foot with specially designed side frame – provides additional protection from ankle twisting, stabilises and guides the foot while providing impact protection
- penetration-resistant, non-metallic midsole in accordance with the latest safety standards, does not restrict flexibility of the shoe

Comfort features:

- outstanding wearer comfort thanks to a newly developed last and climate-optimised, breathable materials with perforation (S1 P model) or water-repellent (S3 model)
- virtually seam-free construction made from high-tech microvelour material to eliminate pressure points
- removable antistatic comfortable insole, with a moisture transport system and additional shock absorption around the heel and forefoot
- soft padding on collar and tongue
- sizes 35 to 40 have been produced using a women's last

Areas of application:

- light applications



| uvex 1 x-tended support | Perforated Shoe S1 P SRC | | | Shoe S3 SRC | | |
|-------------------------|-----------------------------|----------|----------|---------------------------|----------|----------|
| Art. no. | 65681 | 65682 | 65683 | 65671 | 65672 | 65673 |
| Width | 10 | 11 | 12 | 10 | 11 | 12 |
| Standard | EN ISO 20345: 2011 S1 P SRC | | | EN ISO 20345: 2011 S3 SRC | | |
| Upper | microvelour | | | microvelour | | |
| Lining | distance mesh lining | | | distance mesh lining | | |
| Sizes | 35 to 52 | 35 to 52 | 35 to 52 | 35 to 52 | 35 to 52 | 35 to 52 |
| Order unit | PR | PR | PR | PR | PR | PR |

Safety Footwear

uvex 1 ladies



85607
85608



85627
85628



uvex 1 ladies · Sandal S1 SRC · Shoe S2 SRC

General features:

- ultra low weight, versatile S1 safety sandal and S2 safety shoe
- made from synthetic materials, so suitable for people allergic to chrome
- all sole materials are free of silicones, plasticisers and other paint wetting impairment substances
- two adjustable hook-and-loop straps (sandal)
- elastic laces for quick, individual adjustment, normal laces also provided (shoe)

Protection features:

- meets the ESD specification with volume resistance under 35 megaohms
- 100% metal-free uvex xenova® toe cap – compact design, anatomical shape, good lateral stability, no thermal conductivity
- ergonomically designed outsole made from dual density polyurethane with excellent slip resistance

Comfort features:

- outstanding wearer comfort results from a newly developed last and climate-optimised, breathable materials with perforation (sandals)
- virtually seam-free construction made from high-tech microvelour material to eliminate pressure points
- removable antistatic comfortable insole, with a moisture transport system and additional shock absorption around the heel and forefoot
- soft padding on collar and tongue (sandal) or collar and dust tongue (shoe)

| uvex 1 ladies | Sandal S1 SRC | | Shoe S2 SRC | |
|---------------|--------------------------|-------|--------------------------|-------|
| Art. no. | 85607 | 85608 | 85627 | 85628 |
| Width | 10 | 11 | 10 | 11 |
| Standard | EN ISO 20345:2011 S1 SRC | | EN ISO 20345:2011 S2 SRC | |
| Upper | microvelour | | microvelour | |
| Lining | distance mesh lining | | distance mesh lining | |
| Sizes | 35 to 43 | | 35 to 43 | |
| Order unit | PR | | PR | |

Areas of application:

- light applications

All other models in the uvex 1 range are available for women (from size 35).
Product descriptions on pages 269 to 293.



Safety Footwear

uvex 1 ladies



85617
85618



85647
85648



climazone

uvex 1 ladies · Perforated shoe S1 SRC · Perforated lace-up boot S1 SRC

General features:

- ultra low weight and versatile perforated S1 safety shoe/boot
- made from synthetic materials, so suitable for people allergic to chrome
- all sole materials are free of silicones, plasticisers and other paint wetting impairment substances
- elastic laces for quick, individual adjustment, normal laces also provided (shoe)

Protection features:

- meets the ESD specification with volume resistance under 35 megaohms
- 100% metal-free uvex xenova® toe cap – compact design, anatomical shape, good lateral stability, no thermal conductivity
- ergonomically designed outsole made from dual density polyurethane with excellent slip resistance

Comfort features:

- outstanding wearer comfort results from a newly developed last and climate-optimised, breathable materials with perforation
- virtually seam-free construction made from high-tech microvelour material to eliminate pressure points
- removable antistatic comfortable insole, with a moisture transport system and additional shock absorption around the heel and forefoot
- soft padding on collar and tongue

Areas of application:

- light applications

| uvex 1 ladies | Perforated shoe S1 SRC | | Perforated lace-up boot S1 SRC | |
|-------------------|--------------------------|----------|--------------------------------|----------|
| Art. no. | 85617 | 85618 | 85647 | 85648 |
| Width | 10 | 11 | 10 | 11 |
| Standard | EN ISO 20345:2011 S1 SRC | | EN ISO 20345:2011 S1 SRC | |
| Upper | microvelour | | microvelour | |
| Lining | distance mesh lining | | distance mesh lining | |
| Sizes | 35 to 43 | 35 to 43 | 35 to 43 | 35 to 43 |
| Order unit | PR | PR | PR | PR |



Safety Footwear

uvex 1



85521
85522
85523
85524



uvex 1 · Shoe S3 SRC

General features:

- very low weight, versatile S3 safety shoe
- all sole materials are free of silicones, plasticisers and other paint wetting impairment substances
- elastic laces for quick, individual adjustment, normal laces also provided

Protection features:

- meets the ESD specifications with volume resistance under 35 megaohms
- 100% metal-free uvex xenova® toe cap – compact design, anatomical shape, good lateral stability, no thermal conductivity
- penetration-resistant, non-metallic midsole in accordance with the latest safety standards, does not restrict flexibility of the boot
- ergonomically designed outsole made from dual density polyurethane with excellent slip resistance

Comfort features:

- outstanding wearer comfort results from a newly developed last and climate-optimised, breathable materials
- virtually seam-free construction made from particularly soft cowhide leather to eliminate pressure points
- removable antistatic comfortable insole, with a moisture transport system and additional shock absorption around the heel and forefoot
- soft padding on collar and dust tongue
- sizes 35 to 40 have been produced using a women's last

Areas of application:

- light applications

| uvex 1 Shoe S3 SRC | | | | |
|--------------------|--------------------------------------|----------|----------|----------|
| Art. no. | 85521 | 85522 | 85523 | 85524 |
| Width | 10 | 11 | 12 | 14 |
| Standard | EN ISO 20345:2011 S3 SRC | | | |
| Upper | sturdy water-repellent leather upper | | | |
| Lining | distance mesh lining | | | |
| Sizes | 35 to 52 | 35 to 52 | 35 to 52 | 35 to 52 |
| Order unit | PR | PR | PR | PR |



85551
85552
85553
85554



uvex 1 · Lace-up boot S3 SRC

General features:

- very low weight, versatile S3 safety shoe
- all sole materials are free of silicones, plasticisers and other paint wetting impairment substances

Protection features:

- meets the ESD specifications with volume resistance under 35 megaohms
- 100% metal-free uvex xenova® toe cap – compact design, anatomical shape, good lateral stability, no thermal conductivity
- penetration-resistant, non-metallic midsole in accordance with the latest safety standards, does not restrict flexibility of the boot
- ergonomically designed outsole made from dual density polyurethane with excellent slip resistance

Comfort features:

- outstanding wearer comfort results from a newly developed last and climate-optimised, breathable materials
- virtually seam-free construction made from particularly soft cowhide leather to eliminate pressure points
- removable antistatic comfortable insole, with a moisture transport system and additional shock absorption around the heel and forefoot
- soft padding on collar and dust tongue
- sizes 35 to 40 have been produced using a women's last

Areas of application:

- light applications



| uvex 1 Lace-up boot S3 SRC | | | | |
|----------------------------|--------------------------------------|----------|----------|----------|
| Art. no. | 85551 | 85552 | 85553 | 85554 |
| Width | 10 | 11 | 12 | 14 |
| Standard | EN ISO 20345:2011 S3 SRC | | | |
| Upper | sturdy water-repellent leather upper | | | |
| Lining | distance mesh lining | | | |
| Sizes | 35 to 52 | 35 to 52 | 35 to 52 | 35 to 52 |
| Order unit | PR | PR | PR | PR |

uvex 1 business – the best of both worlds

Perfect for the office as well as the workshop.

Do you need to head straight from the meeting room to the production line? uvex's new line of safety shoes brings together three classic looks from the fashion world – Derby shoes, desert boots and Chelsea boots. uvex 1 business safety shoes can go wherever you go, managing to be stylish and safe at the same time! Their attractive appearance blends seamlessly with smart business and casual attire, while their steel cap provides maximum protection with plenty of toe room. Their first-class wearer comfort never fails to impress, from morning to night.

High wearer acceptance

This ultra-lightweight range of safety footwear in a modern business look is available in S2 and S3 versions, in stylish blue or grey.



Proven safety

The extra-wide steel cap, metal-free, penetration-resistant insert and non-slip outsole, which exceeds the requirements of the standard for shock absorption by almost 100%, provide optimum protection.



Breathable materials

The highly breathable, chrome-free materials and antistatic comfortable insole ensure a pleasant foot climate, even during prolonged periods of use.



Comfortable fit

The innovative microvelour material with soft padding and insole with additional shock absorption around the heel and forefoot guarantee a pressure-free fit.



Orthopaedic solutions in accordance with German DGVU 112-191* and Austrian ONORM Z1259

climazone



You can find more information at www.uvex-safety.com/uvex1business

* formerly BGR 191

Highstreet Fashion meets Safety



Safety Footwear

uvex 1 business



84697
84698
84699



84281
84282
84283



uvex 1 business · Shoe S2 SRC · Shoe S3 SRC

General features:

- modern, ultra-lightweight and flexible S2 and S3 safety shoes: safe, stylish and super comfortable in a modern business look
- made from synthetic materials, so suitable for people allergic to chrome
- all sole materials are free of silicones, plasticisers and other paint wetting impairment substances

Protection features:

- meets the ESD specification with volume resistance under 35 megaohms
- robust, extra-wide steel toe cap for maximum wearer comfort
- ergonomically designed outsole made from polyurethane with excellent slip resistance
- penetration-resistant, non-metallic midsole in accordance with the latest safety standards, does not restrict flexibility of the shoe (S3 model)

Comfort features:

- outstanding wearer comfort results from a newly developed last and climate-optimised, breathable materials
- made from high-tech microvelour for a soft, comfortable fit with no pressure points – with soft padding on the collar and a padded tongue
- removable antistatic comfortable insole, with a moisture transport system and additional shock absorption around the heel and forefoot

Areas of application:

- light applications

| uvex 1 business | Shoe S2 SRC | | | Shoe S3 SRC | | |
|-------------------|---------------------------|----------|----------|---------------------------|----------|----------|
| Art. no. | 84697 | 84698 | 84699 | 84281 | 84282 | 84283 |
| Width | 10 | 11 | 12 | 10 | 11 | 12 |
| Standard | EN ISO 20345: 2011 S2 SRC | | | EN ISO 20345: 2011 S3 SRC | | |
| Upper | microvelour | | | microvelour | | |
| Lining | textile lining | | | textile lining | | |
| Sizes | 39 to 52 | 39 to 52 | 39 to 52 | 39 to 52 | 39 to 52 | 39 to 52 |
| Order unit | PR | PR | PR | PR | PR | PR |

Safety Footwear

uvex 1 business



84271
84272
84273



84261
84262
84263



uvex 1 business · Lace-up boot S3 SRC · Slip-on boot S3 SRC

General features:

- modern, ultra-lightweight and flexible S3 safety boot and slip-on boot: safe, stylish and super comfortable in a modern business look
- made from synthetic materials, so suitable for people allergic to chrome
- all sole materials are free of silicones, plasticisers and other paint wetting impairment substances

Protection features:

- meets the ESD specification with volume resistance under 35 megaohms
- robust, extra-wide steel toe cap for maximum wearer comfort
- ergonomically designed outsole made from polyurethane with excellent slip resistance
- penetration-resistant, non-metallic midsole in accordance with the latest safety standards, does not restrict flexibility of the shoe

Comfort features:

- outstanding wearer comfort thanks to a newly developed last and climate-optimised, breathable materials
- made from high-tech microvelour for a soft, comfortable fit with no pressure points – with soft padding on the collar and a padded tongue (boot)
- removable antistatic comfortable insole, with a moisture transport system and additional shock absorption around the heel and forefoot

Areas of application:

- light applications



| uvex 1 business | Lace-up boot S3 SRC | | | Slip-on boot S3 SRC | | |
|-------------------|---------------------------|----------|----------|---------------------------|----------|----------|
| Art. no. | 84271 | 84272 | 84273 | 84261 | 84262 | 84263 |
| Width | 10 | 11 | 12 | 10 | 11 | 12 |
| Standard | EN ISO 20345: 2011 S3 SRC | | | EN ISO 20345: 2011 S3 SRC | | |
| Upper | microvelour | | | microvelour | | |
| Lining | textile lining | | | textile lining | | |
| Sizes | 39 to 52 | 39 to 52 | 39 to 52 | 39 to 52 | 39 to 52 | 39 to 52 |
| Order unit | PR | PR | PR | PR | PR | PR |

uvex business casual
Impeccably styled, exceptional protection

From classically elegant to sports casual: the uvex business casual has something to complement your outfit. Optimum all day protection, whether in the office or on the production floor.



9510

Optimum climate control
Ultra-breathable leather upper and textile lining regulates foot temperature maintaining the optimum 'in shoe' environment. The uvex 'climate comfort' insoles remove moisture and dries completely overnight.

Comfortable fit
The new, anatomically shaped last provides increased stability, supporting the natural movement of the foot without limiting flexibility.

9510
The supple high-quality leather and premium textiles create a durable modern look with high levels of comfort and hygiene for healthy feet.



9511

Shock absorption
The lightweight dual density PU (polyurethane) outsole and removable comfort insole have outstanding shock absorption characteristics which help reduce fatigue and the potential for musculoskeletal conditions.

9511
The combination of the finest, soft leather and suede with 'fabric appliqué' and high-quality, functional textile lining, creates a lightweight shoe and pure wearer comfort.



9512

Safety with every step
The ergonomic sole design and SRC rating delivers excellent slip resistance.

9512
The soft and supple leather upper of this classic 'wingtip Derby brogue' coupled with high-quality functional textiles, results in a comfortable, elegant style and healthy feet.



PU outsole

- ergonomically designed tread
- extremely flexible with outstanding shock absorption
- very lightweight due to unique PU outsole system
- two-layer system with abrasion and cut-resistant outsole
- noticeably improved slip resistance
- self-cleaning tread
- resistance to oil and petrol
- non-marking
- short-term heat resistance up to approximately +120 °C

Safety Footwear

uvex business casual



95102
95108

95112

95122
95128



uvex business casual · Shoe S1 SRC and S1 P SRC

General features:

- lightweight S1 and S1 P safety shoes perfect for office environments: from classically elegant to sporty and casual
- wingtip Derby brogue (95122 and 95128)
- all sole materials are free of silicones, plasticisers and other paint wetting impairment substances

Protection features:

- meets the ESD specification with volume resistance under 35 megaohms
- sturdy steel toe cap
- penetration-resistant steel midsole (S1 P models 95102, 95112 and 95122)
- self-cleaning, lightweight DUO polyurethane outsole with optimal abrasion resistance, shock absorption and excellent slip resistance

Comfort features:

- ideal foot climate constantly maintained due to uvex climazone: moisture-absorbing textile lining, breathable leather upper and comfortable climatic insole with a moisture transport system
- removable antistatic comfortable insole, with additional shock absorption in the heel and forefoot
- soft padding on collar and tongue

Areas of application:

- light applications

| uvex business casual | Shoe S1 P SRC | Shoe S1 SRC |
|----------------------|----------------------------|--------------------------|
| Art. no. | 95102 | 95108 |
| Width | 11 | 11 |
| Standard | EN ISO 20345:2011 S1 P SRC | EN ISO 20345:2011 S1 SRC |
| Upper | leather | leather |
| Lining | textile lining | textile lining |
| Sizes | 38 to 48 | 38 to 48 |
| Order unit | PR | PR |

| uvex business casual | Shoe S1 P SRC |
|----------------------|----------------------------|
| Art. no. | 95112 |
| Width | 11 |
| Standard | EN ISO 20345:2011 S1 P SRC |
| Upper | leather, suede |
| Lining | textile lining |
| Sizes | 38 to 48 |
| Order unit | PR |

| uvex business casual | Shoe S1 P SRC | Shoe S1 SRC |
|----------------------|----------------------------|--------------------------|
| Art. no. | 95122 | 95128 |
| Width | 11 | 11 |
| Standard | EN ISO 20345:2011 S1 P SRC | EN ISO 20345:2011 S1 SRC |
| Upper | leather | leather |
| Lining | textile lining | textile lining |
| Sizes | 38 to 48 | 38 to 48 |
| Order unit | PR | PR |



Safety Footwear

uvex office



95419



95414



95422

uvex office · Shoe S1 SRA

General features:

- office shoe in the classic English style in S1, shape with brogue design

Protection features:

- meets the ESD specification with volume resistance under 35 megaohms (only 95414)
- brief exposure up to 300 °C heat-resistant nitrile rubber outsole
- reliable protection for wearers: steel toe cap and stabilising uvex anti-twist heel cap helps prevent ankle twisting

Comfort features:

- comfortable fit
- ideal foot climate due to breathable lining and flexible, full-grain leather upper
- soft padding on collar
- comfortable insole

Areas of application:

- light applications

| | | |
|-------------------|--------------------------|--------------------------|
| uvex office | Shoe S1 SRA | Shoe S1 SRA |
| Art. no. | 95419 | 95414 |
| Width | 11 | 11 |
| Standard | EN ISO 20345:2011 S1 SRA | EN ISO 20345:2011 S1 SRA |
| Upper | leather | leather |
| Lining | synthetic lining | synthetic lining |
| Sizes | 38 to 47 | 38 to 47 |
| Order unit | PR | PR |

uvex office · Shoe S1 P SRA

General features:

- office shoe in the classic English style in S1 P, shape with brogue design

Protection features:

- reliable protection for wearers: penetration-resistant steel midsole (on S1 P model), steel toe cap and stabilising uvex anti-twist heel cap help prevent ankle twisting

Comfort features:

- comfortable fit
- ideal foot climate due to breathable lining and flexible, full-grain leather upper
- soft padding on collar
- shock-absorbing polyurethane outsole
- comfortable insole

Areas of application:

- light applications

| | |
|-------------------|----------------------------|
| uvex office | Shoe S1 P SRA |
| Art. no. | 95422 |
| Width | 11 |
| Standard | EN ISO 20345:2011 S1 P SRA |
| Upper | leather |
| Lining | synthetic lining |
| Sizes | 38 to 47 |
| Order unit | PR |



uvex office · sole made of nitrile rubber

- extremely comfortable underfoot
- non-slip
- abrasion-resistant
- highly cut-resistant
- outsole is heat-resistant for brief exposure up to +300 °C
- antistatic
- oil and petrol-resistant
- highly acid and alkali-resistant

uvex office · sole made from polyurethane

- extremely comfortable underfoot
- non-slip
- abrasion-resistant
- highly cut-resistant
- outsole is heat-resistant for brief exposure up to +120 °C
- antistatic
- oil and petrol-resistant
- with steel midsole

Safety Footwear

uvex motorsport



94969



94979

climazone

uvex motorsport shoe S1 SRA

General features:

- modern safety shoe in S1 with motor sport look
- flexible abrasion-resistant non-slip rubber outsole

Protection features:

- reliable protection for wearers: steel toe cap and stabilising uvex anti-twist heel cap to prevent ankle twisting

Comfort features:

- textile lining, nappa upper and the removable comfortable climatic insole with a moisture transport system are climate-optimised due to uvex climazone
- extra long lacing area for greater adaptability to individual foot shapes
- optimal shock absorption around the heel with uvex hydroflex® GEL shock absorption system and inner shock-absorbing heel wedge
- soft padding on collar and tongue

Areas of application:

- light applications

| | |
|-----------------------------|--------------------------|
| uvex motorsport shoe S1 SRA | |
| Art. no. | 94969 |
| Width | 11 |
| Standard | EN ISO 20345:2011 S1 SRA |
| Upper | nappa leather and suede |
| | textile lining |
| Sizes | 36 to 48 |
| Order unit | PR |



uvex motorsport sole

- outsole made from nitrile rubber
- outstanding comfort
- non-slip
- abrasion-resistant
- highly cut-resistant
- the outsole is heat-resistant for brief exposure up to +180 °C
- antistatic
- oil and petrol-resistant
- resistant to most acids and alkalis

Safety Footwear

uvex motion style



69752
69758



69788



69798



uvex motion style - Sandal S1 P SRC/S1 SRC

General features:

- low weight safety sandal in S1 P and S1 in a sporty design
- made from synthetic materials, so suitable for people allergic to chrome
- all sole materials are free of silicones, plasticisers and other paint wetting impairment substances
- can be adjusted to fit with two adjustable hook-and-loop straps

Protection features:

- meets the ESD specification with volume resistance under 35 megaohms
- self-cleaning, lightweight PU outsole with optimal abrasion resistance, shock absorption and excellent slip resistance
- reliable protection for wearers: steel toe cap and ,stabilising uvex anti-twist heel cap to prevent ankle twisting
- penetration-resistant, non-metallic midsole in accordance with the latest safety standards, does not restrict flexibility of the shoe (Sandal S1 P)

Comfort features:

- ideal foot climate constantly maintained due to uvex climazone: highly breathable lining and upper with perforation together with comfortable climatic insole with moisture transport system
- comfortable, soft and largely seamless design with no pressure points – with soft padding on collar and tongue
- antistatic uvex 3D hydroflex® foam insole for optimal shock absorption around heel and forefoot

Areas of application:

- light applications

| uvex motion style | Sandal S1 P SRC | Sandal S1 SRC |
|-------------------|----------------------------|--------------------------|
| Art. no. | 69752 | 69758 |
| Width | 11 | 11 |
| Standard | EN ISO 20345:2011 S1 P SRC | EN ISO 20345:2011 S1 SRC |
| Upper | high-tech microvelour | high-tech microvelour |
| Lining | distance mesh lining | distance mesh lining |
| Sizes | 36 to 50 | 36 to 48 |
| Order unit | PR | PR |

uvex motion style - Shoe S2 SRC · Lace-up boot S2 SRC

General features:

- low weight S2 safety shoe and boot with a sporty design
- made from synthetic materials, so suitable for people allergic to chrome
- all sole materials are free of silicones, plasticisers and other paint wetting impairment substances
- elastic laces for quick, individual adjustment (shoe)

Protection features:

- meets the ESD specification with volume resistance under 35 megaohms
- self-cleaning, lightweight PU outsole with optimal abrasion resistance, shock absorption and excellent slip resistance
- reliable protection for wearers: steel toe cap and stabilising uvex anti-twist heel cap help prevent ankle twisting

Comfort features:

- ideal foot climate constantly maintained due to uvex climazone: highly breathable lining and upper together with comfortable climatic insole with moisture transport system
- high-tech microvelour material
- comfortable, soft feel and seamless design with no pressure points – with soft padding on the collar and a padded dust tongue
- antistatic uvex 3D hydroflex® foam insole for optimal shock absorption around heel and forefoot

Areas of application:

- light applications

| uvex motion style | Shoe S2 SRC | Lace-up boot S2 SRC |
|-------------------|--------------------------|--------------------------|
| Art. no. | 69788 | 69798 |
| Width | 11 | 11 |
| Standard | EN ISO 20345:2011 S2 SRC | EN ISO 20345:2011 S2 SRC |
| Upper | high-tech microvelour | high-tech microvelour |
| Lining | distance mesh lining | distance mesh lining |
| Sizes | 36 to 50 | 36 to 50 |
| Order unit | PR | PR |

Safety Footwear

uvex motion style



69988



69898



69678



uvex motion style - Perforated Shoe S1 SRC

General features:

- low weight, perforated S1 safety shoe with a sporty design
- made from synthetic materials, so suitable for people allergic to chrome
- all sole materials are free of silicones, plasticisers and other paint wetting impairment substances
- elastic laces for quick, individual adjustment

Protection features:

- meets the ESD specification with volume resistance under 35 megaohms
- self-cleaning, lightweight PU outsole with optimal abrasion resistance and shock absorption and excellent slip resistance
- reliable protection for wearers: steel toe cap and stabilising uvex anti-twist heel cap to prevent ankle twisting

Comfort features:

- ideal foot climate constantly maintained due to uvex climazone: highly breathable lining and upper with perforation together with comfortable climatic insole with moisture transport system
- comfortable, soft and largely seamless design with no pressure points – with soft padding on collar and tongue
- antistatic uvex 3D hydroflex® foam insole for optimal shock absorption around heel and forefoot

Areas of application:

- light applications

uvex motion style - Perforated Lace-up boot S1 SRC

General features:

- low weight perforated S1 safety boot in a sporty design
- made from synthetic materials, so suitable for people allergic to chrome
- all sole materials are free of silicones, plasticisers and other paint wetting impairment substances

Protection features:

- meets the ESD specification with volume resistance under 35 megaohms
- self-cleaning, lightweight PU outsole with optimal abrasion resistance, shock absorption and excellent slip resistance
- reliable protection for wearers: steel toe cap and ,stabilising uvex anti-twist heel cap to prevent ankle twisting

Comfort features:

- ideal foot climate constantly maintained due to uvex climazone: highly breathable lining and upper with perforation together with comfortable climatic insole with moisture transport system
- comfortable, soft and largely seamless design with no pressure points – with soft padding on collar and tongue
- antistatic uvex 3D hydroflex® foam insole for optimal shock absorption around heel and forefoot

Areas of application:

- light applications



| uvex motion style | Perforated shoe S1 SRC | Perforated shoe S1 SRC |
|-------------------|--------------------------|--------------------------|
| Art. no. | 69898 | 69988 |
| Width | 11 | 11 |
| Standard | EN ISO 20345:2011 S1 SRC | EN ISO 20345:2011 S1 SRC |
| Upper | high-tech microvelour | high-tech microvelour |
| Lining | distance mesh lining | distance mesh lining |
| Sizes | 36 to 50 | 36 to 50 |
| Order unit | PR | PR |

| uvex motion style | Perforated Lace-up boot S1 SRC |
|-------------------|--------------------------------|
| Art. no. | 69678 |
| Width | 11 |
| Standard | EN ISO 20345:2011 S1 SRC |
| Upper | high-tech microvelour |
| Lining | distance mesh lining |
| Sizes | 36 to 48 |
| Order unit | PR |

Winners at Work – uvex 2

Pushing the Limits!



Superior performance across all disciplines

The innovative uvex 2 safety footwear range in protection classes S3, S2 and S1 P is up for the challenge: delivering optimum shock absorption, ergonomic fit, low weight and excellent climate characteristics, ensuring maximum performance and redefining the limits for safety footwear.

Energy-Saving and Lightweight.
Helps prevent fatigue.

Shock Absorption System for Professionals.
Relieve strain with every step.

Reliable stability.
With maximum freedom of movement.

Pressure-free, comfortable fit.
Thanks to uvex monoskin shaft design.

Anatomically designed for optimum comfort and fit.

Comfortable underfoot with climate control.
Highly breathable thanks to uvex climazone.

100% better than the standard
With up to 40 joules of energy absorption in the heel area, the uvex 2 reduces strain on the body.

In spite of the penetration-resistant midsole (S3, S1 P) the energy absorption in the heel is approximately twice that required by EN ISO 20345.

The uvex 2 multilayer shock absorption system and antistatic comfort insole with additional shock absorption elements at the heel and forefoot, help protect the musculoskeletal system on hard or rough terrain.

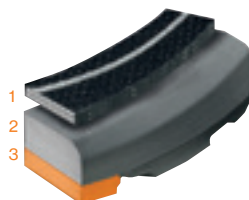
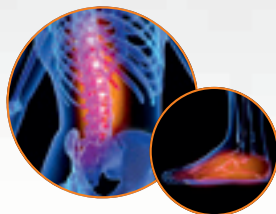

1 Comfort insole
2 PU midsole
3 PU or rubber outsole



Ultra lightweight

The uvex 2 range is one of the lightest S3, S2 and S1 P safety footwear ranges for robust applications in its field.¹



Website



Video

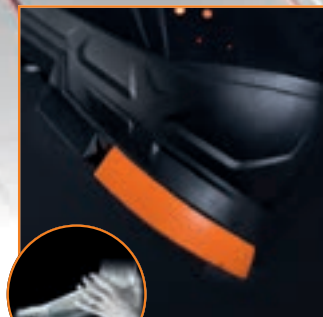

Highly flexible

Enjoy unlimited freedom of movement, especially when kneeling, thanks to the flexible penetration resistant, metal-free midsole. The uvex no tie quick-lace system allows laces to be adjusted easily and adapt throughout the day keeping feet comfortable².

Excellent stability

The directly moulded PU scuffcap reliably protects the upper and prevents wear and tear when kneeling. The externally visible heel basket system integrated into the sole ensures sure-footedness and additional ankle protection without impairing comfort.

² Features depend on model. Standard shoelaces (also supplied) can be used if preferred.

uvex 2

GTX VIBRAM® 100% waterproof. 100% comfortable.

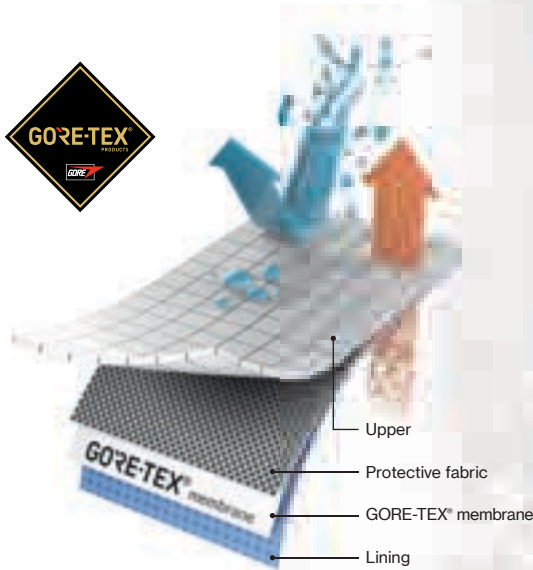

GORE-TEX® Extended Comfort Footwear²

- permanently waterproof and highly breathable
- maximum heat dissipation
- dry and comfortable at high temperatures and during tasks requiring high levels of physical exertion

uvex 2 – rubber sole¹
VIBRAM® – Inspired by Mountaineering

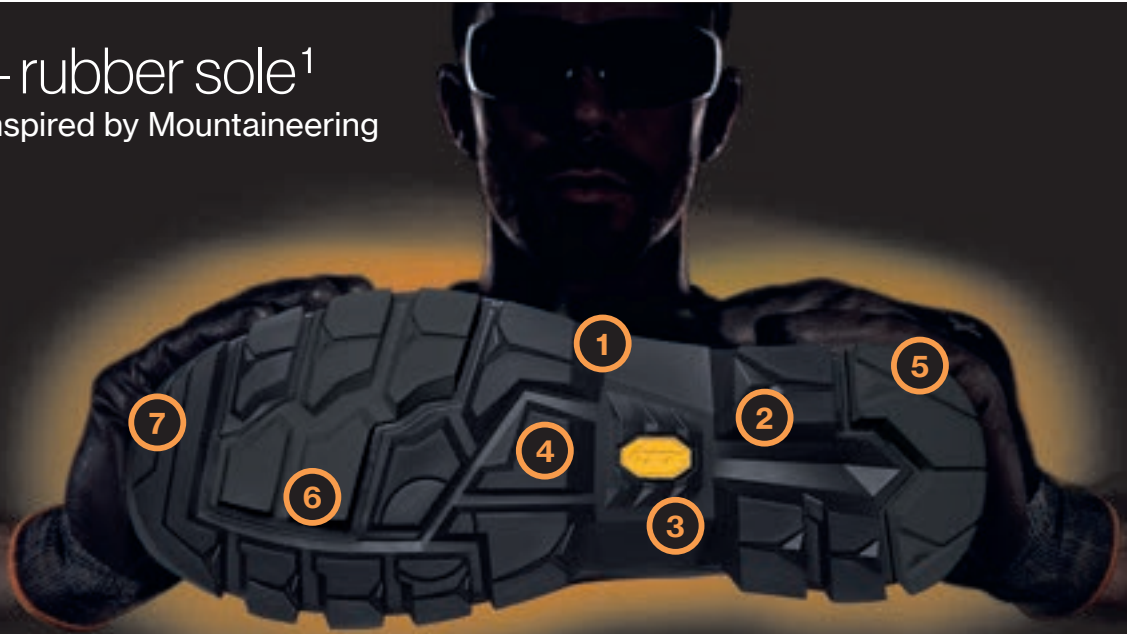

The rubber compound developed exclusively for uvex is optimised for moderately difficult applications with demanding ground conditions and integrates additional features in addition to the basic characteristics of the uvex 2 PU/PU sole:

- ① as light as a PU sole
- ② heat-resistant outsole for short periods up to +300 °C (HRO label)
- ③ increased cut resistance
- ④ heat-insulating (HI label, tested at +150 °C)
- ⑤ increased low-temperature flexibility and slip resistance
- ⑥ improved chemical resistance compared to PU soles
- ⑦ orthopaedic adjustments in accordance with German DGUV regulation 112-191 and Austrian ÖNORM Z1259 possible

Safety Footwear

uvex 2



65261
65262
65263



65271
65272
65273



65331
65332
65333



uvex 2 GTX VIBRAM® · Shoe S3 WR HI HRO SRC · Lace-up boot S3 WR HI HRO SRC

General features:

- lightweight and flexible, waterproof safety shoe / boot in S3 WR
- suitable for people allergic to chrome as made from synthetic materials
- foamed polyurethane scuffcap helps increase product life of upper
- elastic laces for quick, individual adjustment, normal laces also provided (6526x)
- Boa® Fit System (consisting of a micro-adjustable dial, super-strong lightweight laces and low friction lace guides) engineered to optimise fit and provide precision, adaptability, and control (6533x)

Protection features:

- 100% waterproof thanks to GORE-TEX® lining (WR label)
- meets the ESD specification with volume resistance less than 35 megaohms
- 100% metal-free uvex xenova® toe cap – compact design, anatomical shape, good lateral stability, no thermal conductivity
- ultra lightweight, double-layer sole made from optimal shock-absorbing polyurethane midsole and VIBRAM® rubber outsole with excellent anti-slip properties
- HI label for heat-insulating substructure (tested in accordance with standard at +150 °C)
- HRO label for heat-resistant substructure for brief exposure up to +300 °C
- secure grip when climbing on ladders due to the stabilising arch support
- penetration-resistant, non-metallic midsole in accordance with the latest safety standards, does not restrict flexibility of the shoe

Comfort features:

- breathable yet waterproof
- thanks to GORE-TEX® lining, outstanding wearer comfort resulting from a newly developed last and climate-optimised, breathable materials
- virtually seam-free construction made from high-tech microvelour material to eliminate pressure points
- removable antistatic comfortable insole, with a moisture transport system and additional shock absorption around the heel and forefoot
- soft padding on collar and dust tongue
- increased low-temperature flexibility of VIBRAM® rubber sole
- sizes 35 to 40 have been produced using a women's last

Areas of application:

- medium applications

| uvex 2 GTX Vibram® | Shoe S3 WR HI HRO SRC | | | Lace-up boot S3 WR HI HRO SRC | | | Shoe S3 WR HI HRO SRC | | |
|--------------------|------------------------------------|----------|----------|------------------------------------|----------|----------|------------------------------------|----------|----------|
| Art. no. | 65261 | 65262 | 65263 | 65271 | 65272 | 65273 | 65331 | 65332 | 65333 |
| Width | 10 | 11 | 12 | 10 | 11 | 12 | 10 | 11 | 12 |
| Standard | EN ISO 20345:2011 S3 WR HI HRO SRC | | | EN ISO 20345:2011 S3 WR HI HRO SRC | | | EN ISO 20345:2011 S3 WR HI HRO SRC | | |
| Upper | microvelour | | | microvelour | | | microvelour | | |
| Lining | GORE-TEX® laminate | | | GORE-TEX® laminate | | | GORE-TEX® laminate | | |
| Sizes | 35 to 52 | 35 to 52 | 35 to 52 | 35 to 52 | 35 to 52 | 35 to 52 | 35 to 52 | 35 to 52 | 35 to 52 |
| Order unit | PR | PR | PR | PR | PR | PR | PR | PR | PR |

GORE-TEX® is a registered trademark of W. L. GORE & Associates. | VIBRAM® is a registered trademark of VIBRAM S.P.A.

Safety Footwear

uvex 2



65221 65227
65222 65228
65223 65229
65224 65220

65231 65237
65232 65238
65233 65239
65234 65230



uvex 2 VIBRAM® - Shoe S3 HI HRO SRC/S2 HI HRO SRC - Lace-up boot S3 HI HRO SRC/S2 HI HRO SRC

General features:

- lightweight and flexible S2 and S3 safety shoe / boot
- foamed polyurethane scuffcap helps increase product life of upper
- elastic laces for quick, individual adjustment, normal laces also provided (shoe)

Protection features:

- meets the ESD specification with a volume resistance of less than 35 megaohms
- 100% metal-free uvex xenova® toe cap – compact design, anatomical shape, good lateral stability, no thermal conductivity
- ultra lightweight, double-layer sole made from optimal shock-absorbing midsole and VIBRAM® rubber outsole with excellent anti-slip

properties

- HI label for heat-insulating substructure (tested in accordance with standard at +150 °C)
- HRO label for heat-resistant substructure for brief exposure up to +300 °C
- secure grip when climbing on ladders due to the stabilising arch support
- penetration-resistant, non-metallic midsole in accordance with the latest safety standards, does not restrict flexibility of the shoe (on S3 models)

Comfort features:

- outstanding wearer comfort results from a newly developed last and climate-optimised, breathable materials
- virtually seam-free construction made from

particularly soft cowhide leather to eliminate pressure points

- removable antistatic comfortable insole, with a moisture transport system and additional shock absorption around the heel and forefoot
- soft padding on collar and dust tongue
- sizes 35 to 40 have been produced using a women's last

Areas of application:

- medium applications

| uvex 2 VIBRAM® | Shoe S3 HI HRO SRC | | | | Lace-up boot S3 HI HRO SRC | | | |
|----------------|--|----------|----------|----------|--|----------|----------|----------|
| Art. no. | 65221 | 65222 | 65223 | 65224 | 65231 | 65232 | 65233 | 65234 |
| Width | 10 | 11 | 12 | 14 | 10 | 11 | 12 | 14 |
| Standard | EN ISO 20345:2011 S3 HI HRO SRC | | | | EN ISO 20345:2011 S3 HI HRO SRC | | | |
| Upper | water-repellent, full-grain smooth leather | | | | water-repellent, full-grain smooth leather | | | |
| Lining | distance mesh lining | | | | distance mesh lining | | | |
| Sizes | 35 to 52 | 35 to 52 | 35 to 52 | 35 to 52 | 35 to 52 | 35 to 52 | 35 to 52 | 35 to 52 |
| Order unit | PR | PR | PR | PR | PR | PR | PR | PR |

| uvex 2 VIBRAM® | Shoe S2 HI HRO SRC | | | | Lace-up boot S2 HI HRO SRC | | | |
|----------------|--|----------|----------|----------|--|----------|----------|----------|
| Art. no. | 65227 | 65228 | 65229 | 65220 | 65237 | 65238 | 65239 | 65230 |
| Width | 10 | 11 | 12 | 14 | 10 | 11 | 12 | 14 |
| Standard | EN ISO 20345:2011 S2 HI HRO SRC | | | | EN ISO 20345:2011 S2 HI HRO SRC | | | |
| Upper | water-repellent, full-grain smooth leather | | | | water-repellent, full-grain smooth leather | | | |
| Lining | distance mesh lining | | | | distance mesh lining | | | |
| Sizes | 35 to 52 | 35 to 52 | 35 to 52 | 35 to 52 | 35 to 52 | 35 to 52 | 35 to 52 | 35 to 52 |
| Order unit | PR | PR | PR | PR | PR | PR | PR | PR |

VIBRAM® is a registered trademark of VIBRAM S.P.A.



uvex 2 VIBRAM® · Shoe S3 HI HRO SRC · Winter lace-up boot S3 CI HI HRO SRC

General features:

- lightweight and flexible S3 safety shoe and winter safety boot (only available in width 12)
- foamed polyurethane scuffcap helps increase product life of upper
- Boa® Fit System (consisting of a micro-adjustable dial, super-strong lightweight laces and low friction lace guides) engineered to optimise fit and provide precision, adaptability, and control (shoe)

Protection features:

- meets the ESD specification with volume resistance under 35 megaohms
- 100% metal-free uvex xenova® toe cap – compact design, anatomical shape, good lateral stability, no thermal conductivity

- ultra lightweight, double-layer sole made from optimal shock-absorbing midsole and VIBRAM® rubber outsole with excellent anti-slip properties
- insulating shoe design (CI certification in accordance with EN ISO 20345, winter boot only)
- HI marking for heat-insulating substructure (tested in accordance with standard at +150°C)
- HRO marking for heat-resistant substructure for brief exposure up to +300°C
- secure grip when climbing on ladders due to the stabilising arch support
- penetration-resistant, non-metallic midsole in accordance with the latest safety standards, does not restrict flexibility of the shoe

Comfort features:

- outstanding wearer comfort thanks to a newly developed last and climate-optimised, breathable materials
- virtually seam-free construction made from particularly soft cowhide leather to eliminate pressure points
- removable antistatic comfortable insole, with a moisture transport system and additional shock absorption around the heel and forefoot
- soft padding on collar and dust tongue
- sizes 35 to 40 have been produced using a women's last

Areas of application:

- medium applications



| uvex 2 VIBRAM® | Halbschuh S3 HI HRO SRC | | | Winter lace-up boot S3 CI HI HRO SRC |
|-------------------|--------------------------------------|----------|----------|--------------------------------------|
| Art. no. | 65311 | 65312 | 65313 | 65303 |
| Width | 10 | 11 | 12 | 12 |
| Standard | EN ISO 20345:2011 S3 HI HRO SRC | | | EN ISO 20345:2011 S3 CI HI HRO SRC |
| Upper | sturdy water-repellent leather upper | | | sturdy water-repellent leather upper |
| Lining | distance mesh lining | | | fleece lining |
| Sizes | 35 to 52 | 35 to 52 | 35 to 52 | 35 to 52 |
| Order unit | PR | PR | PR | PR |

VIBRAM® is a registered trademark of VIBRAM S.P.A.

Safety Footwear

uvex 2



65201
65202
65203
65204



65211
65212
65213
65214



uvex 2 VIBRAM® · Sandal S1 P HRO SRC · Perforated shoe S1 P HRO SRC

General features:

- lightweight and flexible S1 P safety sandal / perforated safety shoe
- suitable for people allergic to chrome as made from synthetic materials
- foamed polyurethane scuffcap helps increase product life of upper
- two adjustable velcro straps (sandal) or elastic laces for quick, individual adjustment; normal laces also provided (shoe)

Protection features:

- meets the ESD specification with volume resistance less than 35 megaohms
- 100% metal-free uvex xenova® toe cap – compact design, anatomical shape, good lateral stability, no thermal conductivity
- ultra lightweight, double-layer sole made from optimal shock-absorbing polyurethane midsole and VIBRAM® rubber outsole with excellent anti-slip properties
- HRO label for heat-resistant substructure for brief exposure up to +300 °C
- secure grip when climbing on ladders due to the stabilising arch support
- penetration-resistant, non-metallic midsole in accordance with the latest safety standards, does not restrict flexibility of the shoe

Comfort features:

- outstanding wearer comfort results from a newly developed last and climate-optimised, breathable, perforated materials
- virtually seam-free construction made from high-tech microvelour material to eliminate pressure points
- removable antistatic comfortable insole, with a moisture transport system and additional shock absorption around the heel and forefoot
- increased low-temperature flexibility of VIBRAM® rubber sole
- sizes 35 to 40 have been produced using a women's last

Areas of application:

- medium applications

| uvex 2 VIBRAM® | Sandal S1 P HRO SRC | | | | Perforated shoe S1 P HRO SRC | | | |
|----------------|--------------------------------|----------|----------|----------|--------------------------------|----------|----------|----------|
| Art. no. | 65201 | 65202 | 65203 | 65204 | 65211 | 65212 | 65213 | 65214 |
| Width | 10 | 11 | 12 | 14 | 10 | 11 | 12 | 14 |
| Standard | EN ISO 20345:2011 S1 P HRO SRC | | | | EN ISO 20345:2011 S1 P HRO SRC | | | |
| Upper | microvelour | | | | microvelour | | | |
| Lining | distance mesh lining | | | | distance mesh lining | | | |
| Sizes | 35 to 52 | 35 to 52 | 35 to 52 | 35 to 52 | 35 to 52 | 35 to 52 | 35 to 52 | 35 to 52 |
| Order unit | PR | PR | PR | PR | PR | PR | PR | PR |

Safety Footwear

uvex 2



65281
65282
65283
65284

65291
65292
65293
65294



climazone

uvex 2 VIBRAM® · Shoe S3 HI HRO SRC · Lace-up boot S3 HI HRO SRC

General features:

- lightweight and flexible S3 safety shoe / boot
- suitable for people allergic to chrome as made from synthetic materials
- foamed polyurethane scuffcap helps increase product life of upper
- elastic laces for quick, individual adjustment, normal laces also provided (shoe)

Protection features:

- meets the ESD specification with volume resistance less than 35 megaohms
- 100% metal-free uvex xenova® toe cap – compact design, anatomical shape, good lateral stability, no thermal conductivity
- ultra lightweight, double-layer sole made from optimal shock-absorbing polyurethane midsole and VIBRAM® rubber outsole with excellent anti-slip properties
- HI label for heat-insulating substructure (tested in accordance with standard at +150 °C)
- HRO label for heat-resistant substructure for brief exposure up to +300 °C
- secure grip when climbing on ladders due to the stabilising arch support
- penetration-resistant, non-metallic midsole in accordance with the latest safety standards, does not restrict flexibility of the shoe

Comfort features:

- outstanding wearer comfort results from a newly developed last and climate-optimised, breathable materials
- virtually seam-free construction made from high-tech microvelour material to eliminate pressure points
- removable antistatic comfortable insole, with a moisture transport system and additional shock absorption around the heel and forefoot
- soft padding on collar and dust tongue
- increased low-temperature flexibility of VIBRAM® rubber sole
- sizes 35 to 40 have been produced using a women's last

Areas of application:

- medium applications



| uvex 2 VIBRAM® | Shoe S3 HI HRO SRC | | | | Lace-up boot S3 HI HRO SRC | | | |
|----------------|---------------------------------|----------|----------|----------|---------------------------------|----------|----------|----------|
| Art. no. | 65281 | 65282 | 65283 | 65284 | 65291 | 65292 | 65293 | 65294 |
| Width | 10 | 11 | 12 | 14 | 10 | 11 | 12 | 14 |
| Standard | EN ISO 20345:2011 S3 HI HRO SRC | | | | EN ISO 20345:2011 S3 HI HRO SRC | | | |
| Upper | microvelour | | | | microvelour | | | |
| Lining | distance mesh lining | | | | distance mesh lining | | | |
| Sizes | 35 to 52 | 35 to 52 | 35 to 52 | 35 to 52 | 35 to 52 | 35 to 52 | 35 to 52 | 35 to 52 |
| Order unit | PR | PR | PR | PR | PR | PR | PR | PR |

VIBRAM® is a registered trademark of VIBRAM S.P.A.

uvex 2 PU/PU Sole

Optimum Grip with every Step



Walk and stand safely. Outdoor sole with excellent grip properties and optimum shock absorption

- 1** Effective ankle protection to ensure safety when working on ladders.
- 2** Resistant to oil and petrol. Resistant to temperatures for short periods up to +120 °C.
- 3** Orthopaedic adjustments in accordance with German DGUV regulation 112-191 and Austrian ÖNORM Z1259 possible
- 4** Free from harmful substances that interfere with wetting agents.
- 5** Abrasion-resistant TPU sections for secure foot placement to help prevent accidents.
- 6** Rugged, self-cleaning sole ensures maximum grip for demanding applications, uneven or dirty floors (SRC labelling).
- 7** Meets ESD requirements: bleed resistance < 35 megaohm.
- 8** Slip resistance (SRC)

Safety Footwear

uvex 2



65021 65027
65022 65028
65023 65029
65024 65020

65031 65037
65032 65038
65033 65039
65034 65030



climazone

uvex 2 · Shoe S3 SRC/S2 SRC · Lace-up boot S3 SRC/S2 SRC

General features:

- low weight and flexible S2 and S3 safety shoe/boot
- all sole materials are free of silicones, plasticisers and other paint wetting impairment substances
- foamed polyurethane scuffcap helps protect upper and increase product life
- elastic laces for quick, individual adjustment, normal laces also provided (shoe)

Protection features:

- meets the ESD specification with volume resistance under 35 megaohms
- 100% metal-free uvex xenova® toe cap –

compact design, anatomical shape, good lateral stability, no thermal conductivity

- ergonomically designed outsole made from dual density polyurethane with a rough, self-cleaning tread and excellent slip resistance
- secure grip when climbing on ladders due to the stabilising arch support
- penetration-resistant, non-metallic midsole in accordance with the latest safety standards, does not restrict flexibility of the shoe (on S3 models)

Comfort features:

- outstanding wearer comfort results from a newly developed last and climate-optimised, breathable materials
- virtually seam-free construction made from particularly soft cowhide leather to eliminate pressure points
- removable antistatic comfortable insole, with a moisture transport system and additional shock absorption around the heel and forefoot
- soft padding on collar and dust tongue
- sizes 35 to 40 have been produced using a women's last

Areas of application:

- medium applications



| uvex 2 | Shoe S2 SRC | | | | Lace-up boot S2 SRC | | | |
|------------|--|----------|----------|----------|--|----------|----------|----------|
| Art. no. | 65027 | 65028 | 65029 | 65020 | 65037 | 65038 | 65039 | 65030 |
| Width | 10 | 11 | 12 | 14 | 10 | 11 | 12 | 14 |
| Standard | EN ISO 20345:2011 S2 SRC | | | | EN ISO 20345:2011 S2 SRC | | | |
| Upper | water-repellent, full-grain smooth leather | | | | water-repellent, full-grain smooth leather | | | |
| Lining | distance mesh lining | | | | distance mesh lining | | | |
| Sizes | 35 to 52 | 35 to 52 | 35 to 52 | 35 to 52 | 35 to 52 | 35 to 52 | 35 to 52 | 35 to 52 |
| Order unit | PR | PR | PR | PR | PR | PR | PR | PR |

| uvex 2 | Shoe S3 SRC | | | | Lace-up boot S3 SRC | | | |
|------------|--|----------|----------|----------|--|----------|----------|----------|
| Art. no. | 65021 | 65022 | 65023 | 65024 | 65031 | 65032 | 65033 | 65034 |
| Width | 10 | 11 | 12 | 14 | 10 | 11 | 12 | 14 |
| Standard | EN ISO 20345:2011 S3 SRC | | | | EN ISO 20345:2011 S3 SRC | | | |
| Upper | water-repellent, full-grain smooth leather | | | | water-repellent, full-grain smooth leather | | | |
| Lining | distance mesh lining | | | | distance mesh lining | | | |
| Sizes | 35 to 52 | 35 to 52 | 35 to 52 | 35 to 52 | 35 to 52 | 35 to 52 | 35 to 52 | 35 to 52 |
| Order unit | PR | PR | PR | PR | PR | PR | PR | PR |

Safety Footwear

uvex 2



65001
65002
65003
65004



65011
65012
65013
65014



climazone

uvex 2 · Shoe S1 P SRC · Perforated shoe S1 P SRC

General features:

- lightweight and flexible S1 P safety sandal / perforated safety shoe
- suitable for people allergic to chrome as made from synthetic materials
- foamed polyurethane scuffcap helps increase product life of upper
- two adjustable velcro straps (sandal) or elastic laces for quick, individual adjustment; normal laces also provided (shoe)

Protection features:

- meets the ESD specification with a volume resistance of less than 35 megaohms
- 100% metal-free uvex xenova® toe cap – compact design, anatomical shape, good lateral stability, no thermal conductivity
- ergonomically designed outsole made from dual-density polyurethane with a rough, self-cleaning tread and excellent slip resistance
- secure grip when climbing on ladders due to the stabilising arch support
- penetration-resistant, non-metallic insole in accordance with the latest safety standards, does not restrict flexibility of the shoe

Comfort features:

- outstanding wearer comfort results from a newly developed last and climate-optimised, breathable, perforated materials
- virtually seam-free construction made from high-tech microvelour material to eliminate pressure points
- removable antistatic comfortable insole, with a moisture transport system and additional shock absorption around the heel and forefoot
- sizes 35 to 40 have been produced using a women's last

Areas of application:

- medium applications

| uvex 2 | Sandal S1 P SRC | | | | Perforated shoe S1 P SRC | | | |
|-------------------|----------------------------|----------|----------|----------|----------------------------|----------|----------|----------|
| Art. no. | 65001 | 65002 | 65003 | 65004 | 65011 | 65012 | 65013 | 65014 |
| Width | 10 | 11 | 12 | 14 | 10 | 11 | 12 | 14 |
| Standard | EN ISO 20345:2011 S1 P SRC | | | | EN ISO 20345:2011 S1 P SRC | | | |
| Upper | microvelour | | | | microvelour | | | |
| Lining | distance mesh lining | | | | distance mesh lining | | | |
| Sizes | 35 to 52 | 35 to 52 | 35 to 52 | 35 to 52 | 35 to 52 | 35 to 52 | 35 to 52 | 35 to 52 |
| Order unit | PR | PR | PR | PR | PR | PR | PR | PR |

Safety Footwear

uvex 2



65081
65082
65083
65084



65091
65092
65093
65094



climazone

uvex 2 · Shoe S3 SRC · Lace-up boot S3 SRC

General features:

- lightweight and flexible S3 safety shoe / boot
- suitable for people allergic to chrome as made from synthetic materials
- foamed polyurethane scuffcap helps increase product life of upper
- elastic laces for quick, individual adjustment, normal laces also provided (shoe)

Protection features:

- meets the ESD specification with a volume resistance of less than 35 megaohms
- 100% metal-free uvex xenova® toe cap – compact design, anatomical shape, good lateral stability, no thermal conductivity
- ergonomically designed outsole made from dual-density polyurethane with a rough, self-cleaning tread and excellent slip resistance
- secure grip when climbing on ladders due to the stabilising arch support
- penetration-resistant, non-metallic midsole in accordance with the latest safety standards, does not restrict flexibility of the shoe

Comfort features:

- outstanding wearer comfort results from a newly developed last and climate-optimised, breathable materials
- virtually seam-free construction made from high-tech microvelour material to eliminate pressure points
- removable antistatic comfortable insole, with a moisture transport system and additional shock absorption around the heel and forefoot
- soft padding on collar and dust tongue
- sizes 35 to 40 have been produced using a women's last

Areas of application:

- medium applications



| uvex 2 | Shoe S3 SRC | | | | Lace-up boot S3 SRC | | | |
|-------------------|--------------------------|----------|----------|----------|--------------------------|----------|----------|----------|
| Art. no. | 65081 | 65082 | 65083 | 65084 | 65091 | 65092 | 65093 | 65094 |
| Width | 10 | 11 | 12 | 14 | 10 | 11 | 12 | 14 |
| Standard | EN ISO 20345:2011 S3 SRC | | | | EN ISO 20345:2011 S3 SRC | | | |
| Upper | microvelour | | | | microvelour | | | |
| Lining | distance mesh lining | | | | distance mesh lining | | | |
| Sizes | 35 to 52 | 35 to 52 | 35 to 52 | 35 to 52 | 35 to 52 | 35 to 52 | 35 to 52 | 35 to 52 |
| Order unit | PR | PR | PR | PR | PR | PR | PR | PR |

uvex 2 xenova® – robust variety

Trend-setting all-rounder



Indoor and outdoor use

uvex 2 xenova® safety shoe series – exceptional, robust and comfortable shoes, whatever you're doing. Whether indoors or outdoors, the uvex 2 xenova® are the right choice for applications such as mechanical and plant engineering, metal processing, energy (generation, supply &

grid operation), municipal operations, motorway maintenance, railways, transport & logistics, airports, trades, ancillary construction work, horticulture and landscaping. uvex 2 xenova® – the trend-setting allrounders for a wide range of applications.

Metal-free safety

The uvex xenova® system offers high levels of safety thanks to its metal-free toe cap and optional metal-free, penetration-resistant

flexible midsole that keeps out the cold, and is lightweight and flexible for lasting wearer comfort.



Comfortable, lightweight shoes

The uvex 2 xenova® safety shoes do not compromise when it comes to comfort: shock-absorbing, extremely breathable, lightweight and a perfect fit thanks to

the unique combination of uvex technologies.



You can find more information at www.uvex-safety.com/uvex2xenova



uvex climazone standard The ultra-breathable high-tech microvelour upper material, distance mesh lining and comfortable insole with moisture transport system prevent the build-up of heat and reduce uncomfortable sweating.



Excellent fit due to newly developed last and uvex multiple fit system – available in 3 widths.



Lightweight and robust uvex dual density polyurethane sole with excellent slip resistance (SRC) and multi-layer shock absorption.

Impressively diverse

Made from high-quality black micro velour or smooth leather, the uvex 2 xenova® series offers an impressively wide variety of styles in accent colours blue, green and red in protection classes S1, S1 P, S2 and S3.

An overview of all uvex 2 xenova® models can be found on page 318.





uvex 2 xenova®

Model overview

| uvex 2 xenova® with microvelour upper | | | |
|---|---|---|---|
| S1 Sandal |  95537 95538 95539 |  95597 95598 95599 |  95047 95048 95049 |
| S1P Sandal |  95531 95532 95533 |  95591 95592 95593 |  95041 95042 95043 |
| S1 Perforated shoe |  95547 95548 95549 |  95607 95608 95609 |  95057 95058 95059 |
| S1P Perforated shoe with Boa® Fit System |  95581 95582 95583 | | |
| S2 Shoe |  95577 95578 95579 |  95687 95688 95689 |  95087 95088 95089 |
| uvex 2 xenova® with leather upper | | | |
| S2 Shoe |  95557 95558 95559 |  95647 95648 95649 |  95067 95068 95069 |
| S2 Lace-up boot |  95567 95568 95569 |  95667 95668 95669 |  95077 95078 95079 |
| S3 Shoe |  95551 95552 95553 |  95641 95642 95643 |  95061 95062 95063 |
| S3 Lace-up boot |  95561 95562 95563 |  95661 95662 95663 |  95071 95072 95073 |

Safety Footwear

uvex 2 xenova®



95537
95538
95539



95597
95598
95599



95047
95048
95049



climazone

uvex 2 xenova® · Sandal S1 SRC

General features:

- lightweight and modern S1 safety sandals
- made from synthetic materials, so suitable for people allergic to chrome
- all sole materials are free of silicones, plasticisers and other paint wetting impairment substances
- double, individually adjustable hook and loop straps

Protection features:

- meets the ESD specifications with volume resistance under 35 megaohms
- 100% metal-free uvex xenova® safety toe cap – compact design, anatomical shape, good lateral stability, no thermal conductivity
- ergonomically designed outsole made from dual density polyurethane with excellent slip resistance
- reflective elements for better visibility

Comfort features:

- lightweight with excellent shock-absorbing properties
- outstanding wearer comfort thanks to a newly developed last and climate-optimised, breathable materials
- removable antistatic comfortable insole, with a moisture transport system and additional shock absorption around the heel and forefoot
- soft padding on tongue and collar

Areas of application:

- medium applications



| uvex 2 xenova® | Sandal S1 SRC | | | Sandal S1 SRC | | | Sandal S1 SRC | | |
|----------------|--------------------------|----------|----------|---------------|----------|----------|---------------|----------|----------|
| Art. no. | 95537 | 95538 | 95539 | 95597 | 95598 | 95599 | 95047 | 95048 | 95049 |
| Width | 10 | 11 | 12 | 10 | 11 | 12 | 10 | 11 | 12 |
| Standard | EN ISO 20345:2011 S1 SRC | | | | | | | | |
| Upper | microvelour | | | | | | | | |
| Lining | distance mesh lining | | | | | | | | |
| Sizes | 38 to 52 | 38 to 52 | 38 to 52 | 38 to 52 | 38 to 52 | 38 to 52 | 38 to 52 | 38 to 52 | 38 to 52 |
| Order unit | PR | PR | PR | PR | PR | PR | PR | PR | PR |

Safety Footwear

uvex 2 xenova®



95531
95532
95533

95591
95592
95593

95041
95042
95043



climazone

uvex 2 xenova® · Sandal S1 P SRC

General features:

- lightweight and modern S1 P safety sandals
- made from synthetic materials, so suitable for people allergic to chrome
- all sole materials are free of silicones, plasticisers and other paint wetting impairment substances
- double, individually adjustable hook and loop straps

Protection features:

- meets the ESD specifications with volume resistance under 35 megaohms
- 100% metal-free uvex xenova® safety toe cap – compact design, anatomical shape, good lateral stability, no thermal conductivity
- penetration-resistant, non-metallic midsole in accordance with the latest safety standards, does not restrict flexibility of the shoe
- ergonomically designed outsole made from dual density polyurethane with excellent slip resistance
- reflective elements for better visibility

Comfort features:

- lightweight with excellent shock-absorbing properties
- outstanding wearer comfort thanks to a newly developed last and climate-optimised, breathable materials
- removable antistatic comfortable insole, with a moisture transport system and additional shock absorption around the heel and forefoot
- soft padding on tongue and collar

Areas of application:

- medium applications

| uvex 2 xenova® | Sandal S1 P SRC | | | Sandal S1 P SRC | | | Sandal S1 P SRC | | |
|----------------|----------------------------|----------|----------|-----------------|----------|----------|-----------------|----------|----------|
| Art. no. | 95531 | 95532 | 95533 | 95591 | 95592 | 95593 | 95041 | 95042 | 95043 |
| Width | 10 | 11 | 12 | 10 | 11 | 12 | 10 | 11 | 12 |
| Standard | EN ISO 20345:2011 S1 P SRC | | | | | | | | |
| Upper | microvelour | | | | | | | | |
| Lining | distance mesh lining | | | | | | | | |
| Sizes | 38 to 52 | 38 to 52 | 38 to 52 | 38 to 52 | 38 to 52 | 38 to 52 | 38 to 52 | 38 to 52 | 38 to 52 |
| Order unit | PR | PR | PR | PR | PR | PR | PR | PR | PR |

Safety Footwear

uvex 2 xenova®



95547
95548
95549

95607
95608
95609

95057
95058
95059



climazone

uvex 2 xenova® · Perforated shoe S1 SRC

General features:

- lightweight, modern, perforated S1 safety shoe
- made from synthetic materials, so suitable for people allergic to chrome
- all sole materials are free of silicones, plasticisers and other paint wetting impairment substances
- double, individually adjustable hook and loop straps

Protection features:

- meets the ESD specifications with volume resistance under 35 megaohms
- 100% metal-free uvex xenova® safety toe cap – compact design, anatomical shape, good lateral stability, no thermal conductivity
- ergonomically designed outsole made from dual density polyurethane with excellent slip resistance
- reflective elements for better visibility

Comfort features:

- lightweight with excellent shock-absorbing properties
- outstanding wearer comfort thanks to a newly developed last and climate-optimised, breathable materials, plus perforated upper
- removable antistatic comfortable insole, with a moisture transport system and additional shock absorption around the heel and forefoot
- soft padding on tongue and collar

Areas of application:

- medium applications



| uvex 2 xenova® | Perforated shoe S1 SRC | | | Perforated shoe S1 SRC | | | Perforated shoe S1 SRC | | |
|----------------|--------------------------|----------|----------|------------------------|----------|----------|------------------------|----------|----------|
| Art. no. | 95547 | 95548 | 95549 | 95607 | 95608 | 95609 | 95057 | 95058 | 95059 |
| Width | 10 | 11 | 12 | 10 | 11 | 12 | 10 | 11 | 12 |
| Standard | EN ISO 20345:2011 S1 SRC | | | | | | | | |
| Upper | microvelour | | | | | | | | |
| Lining | distance mesh lining | | | | | | | | |
| Sizes | 38 to 52 | 38 to 52 | 38 to 52 | 38 to 52 | 38 to 52 | 38 to 52 | 38 to 52 | 38 to 52 | 38 to 52 |
| Order unit | PR | PR | PR | PR | PR | PR | PR | PR | PR |

Safety Footwear

uvex 2 xenova®



95581
95582
95583



uvex 2 xenova® · Perforated shoe S1 P SRC

General features:

- lightweight, modern, perforated S1 P safety shoe
- made from synthetic materials, so suitable for people allergic to chrome
- all sole materials are free of silicones, plasticisers and other paint wetting impairment substances
- Boa® Fit System (consisting of a micro-adjustable dial, super-strong lightweight laces and low friction lace guides) engineered to optimise fit and provide precision, adaptability, and control.

Protection features:

- meets the ESD specifications with volume resistance under 35 megaohms
- 100% metal-free uvex xenova® safety toe cap – compact design, anatomical shape, good lateral stability, no thermal conductivity
- penetration-resistant, non-metallic midsole in accordance with the latest safety standards, does not restrict flexibility of the shoe
- ergonomically designed outsole made from dual density polyurethane with excellent slip resistance
- reflective elements for better visibility

Comfort features:

- lightweight with excellent shock-absorbing properties
- outstanding wearer comfort thanks to a newly developed last and climate-optimised, breathable materials, plus perforated upper
- removable antistatic comfortable insole, with a moisture transport system and additional shock absorption around the heel and forefoot
- soft padding on tongue and collar

Areas of application:

- medium applications

| uvex 2 xenova® | Perforated shoe S1 P SRC | | |
|----------------|----------------------------|----------|----------|
| Art. no. | 95581 | 95582 | 95583 |
| Width | 10 | 11 | 12 |
| Standard | EN ISO 20345:2011 S1 P SRC | | |
| Upper | microvelour | | |
| Lining | distance mesh lining | | |
| Sizes | 38 to 52 | 38 to 52 | 38 to 52 |
| Order unit | PR | PR | PR |

Safety Footwear

uvex 2 xenova®



95577
95578
95579



95687
95688
95689



95087
95088
95089



climazone

uvex 2 xenova® · Shoe S2 SRC

General features:

- lightweight, modern S2 safety shoe
- made from synthetic materials, so suitable for people allergic to chrome
- all sole materials are free of silicones, plasticisers and other paint wetting impairment substances
- double, individually adjustable hook and loop straps

Protection features:

- meets the ESD specifications with volume resistance under 35 megaohms
- 100% metal-free uvex xenova® safety toe cap – compact design, anatomical shape, good lateral stability, no thermal conductivity
- ergonomically designed outsole made from dual density polyurethane with excellent slip resistance
- reflective elements for better visibility

Comfort features:

- lightweight with excellent shock-absorbing properties
- outstanding wearer comfort thanks to a newly developed last and climate-optimised, breathable materials
- removable antistatic comfortable insole, with a moisture transport system and additional shock absorption around the heel and forefoot
- soft padding on dust tongue and collar

Areas of application:

- medium applications



| uvex 2 xenova® | Shoe S2 SRC | | | Shoe S2 SRC | | | Shoe S2 SRC | | |
|----------------|--------------------------|----------|----------|-------------|----------|----------|-------------|----------|----------|
| Art. no. | 95577 | 95578 | 95579 | 95687 | 95688 | 95689 | 95087 | 95088 | 95089 |
| Width | 10 | 11 | 12 | 10 | 11 | 12 | 10 | 11 | 12 |
| Standard | EN ISO 20345:2011 S2 SRC | | | | | | | | |
| Upper | microvelour | | | | | | | | |
| Lining | distance mesh lining | | | | | | | | |
| Sizes | 38 to 52 | 38 to 52 | 38 to 52 | 38 to 52 | 38 to 52 | 38 to 52 | 38 to 52 | 38 to 52 | 38 to 52 |
| Order unit | PR | PR | PR | PR | PR | PR | PR | PR | PR |

Safety Footwear

uvex 2 xenova®



95557
95558
95559

95647
95648
95649

95067
95068
95069



climazone

uvex 2 xenova® · Shoe S2 SRC

General features:

- extremely lightweight, versatile S2 safety shoe
- all sole materials are free of silicones, plasticisers and other paint wetting impairment substances
- heat-resistant loop lacing system

Protection features:

- meets the ESD specifications with volume resistance under 35 megaohms
- 100% metal-free uvex xenova® safety toe cap – compact design, anatomical shape, good lateral stability, no thermal conductivity
- ergonomically designed outsole made from dual density polyurethane with excellent slip resistance
- reflective elements for better visibility

Comfort features:

- lightweight with excellent shock-absorbing properties
- outstanding wearer comfort thanks to a newly developed last and climate-optimised, breathable materials
- removable antistatic comfortable insole, with a moisture transport system and additional shock absorption around the heel and forefoot
- soft padding on dust tongue and collar

Areas of application:

- medium applications

| uvex 2 xenova® | Shoe S2 SRC | | | Shoe S2 SRC | | | Shoe S2 SRC | | |
|-------------------|-------------------------------------|----------|----------|-------------|----------|----------|-------------|----------|----------|
| Art. no. | 95557 | 95558 | 95559 | 95647 | 95648 | 95649 | 95067 | 95068 | 95069 |
| Width | 10 | 11 | 12 | 10 | 11 | 12 | 10 | 11 | 12 |
| Standard | EN ISO 20345:2011 S2 SRC | | | | | | | | |
| Upper | water-repellent, full-grain leather | | | | | | | | |
| Lining | distance mesh lining | | | | | | | | |
| Sizes | 38 to 52 | 38 to 52 | 38 to 52 | 38 to 52 | 38 to 52 | 38 to 52 | 38 to 52 | 38 to 52 | 38 to 52 |
| Order unit | PR | PR | PR | PR | PR | PR | PR | PR | PR |

Safety Footwear

uvex 2 xenova®



95567
95568
95569

95667
95668
95669

95077
95078
95079



climazone

uvex 2 xenova® · Lace-up boot S2 SRC

General features:

- extremely lightweight, versatile S2 lace-up safety boot
- all sole materials are free of silicones, plasticisers and other paint wetting impairment substances
- heat-resistant loop lacing system and two pairs of lacing hooks

Protection features:

- meets the ESD specifications with volume resistance under 35 megaohms
- 100% metal-free uvex xenova® safety toe cap – compact design, anatomical shape, good lateral stability, no thermal conductivity
- ergonomically designed outsole made from dual density polyurethane with excellent slip resistance
- reflective elements for better visibility

Comfort features:

- lightweight with excellent shock-absorbing properties
- outstanding wearer comfort thanks to a newly developed last and climate-optimised, breathable materials
- removable antistatic comfortable insole, with a moisture transport system and additional shock absorption around the heel and forefoot
- soft padding on dust tongue and collar

Areas of application:

- medium applications



| uvex 2 xenova® | Lace-up boot S2 SRC | | | Lace-up boot S2 SRC | | | Lace-up boot S2 SRC | | |
|-------------------|-------------------------------------|----------|----------|---------------------|----------|----------|---------------------|----------|----------|
| Art. no. | 95567 | 95568 | 95569 | 95667 | 95668 | 95669 | 95077 | 95078 | 95079 |
| Width | 10 | 11 | 12 | 10 | 11 | 12 | 10 | 11 | 12 |
| Standard | EN ISO 20345:2011 S2 SRC | | | | | | | | |
| Upper | water-repellent, full-grain leather | | | | | | | | |
| Lining | distance mesh lining | | | | | | | | |
| Sizes | 38 to 52 | 38 to 52 | 38 to 52 | 38 to 52 | 38 to 52 | 38 to 52 | 38 to 52 | 38 to 52 | 38 to 52 |
| Order unit | PR | PR | PR | PR | PR | PR | PR | PR | PR |

Safety Footwear

uvex 2 xenova®



95551
95552
95553

95641
95642
95643

95061
95062
95063



climazone

uvex 2 xenova® · Shoe S3 SRC

General features:

- extremely lightweight, versatile S3 safety shoe
- upper over the toe cap lasts longer thanks to the PU-coated leather scuffcap
- all sole materials are free of silicones, plasticisers and other paint wetting impairment substances
- heat-resistant loop lacing system

Protection features:

- meets the ESD specifications with volume resistance under 35 megaohms
- 100% metal-free uvex xenova® safety toe cap – compact design, anatomical shape, good lateral stability, no thermal conductivity
- penetration-resistant, non-metallic midsole in accordance with the latest safety standards, does not restrict flexibility of the shoe
- ergonomically designed outsole made from dual density polyurethane with excellent slip resistance
- reflective elements for better visibility

Comfort features:

- lightweight with excellent shock-absorbing properties
- outstanding wearer comfort thanks to a newly developed last and climate-optimised, breathable materials
- removable antistatic comfortable insole, with a moisture transport system and additional shock absorption around the heel and forefoot
- soft padding on dust tongue and collar

Areas of application:

- medium applications

| uvex 2 xenova® | Shoe S3 SRC | | | Shoe S3 SRC | | | Shoe S3 SRC | | |
|----------------|-------------------------------------|----------|----------|-------------|----------|----------|-------------|----------|----------|
| Art. no. | 95551 | 95552 | 95553 | 95641 | 95642 | 95643 | 95061 | 95062 | 95063 |
| Width | 10 | 11 | 12 | 10 | 11 | 12 | 10 | 11 | 12 |
| Standard | EN ISO 20345:2011 S3 SRC | | | | | | | | |
| Upper | water-repellent, full-grain leather | | | | | | | | |
| Lining | distance mesh lining | | | | | | | | |
| Sizes | 38 to 52 | 38 to 52 | 38 to 52 | 38 to 52 | 38 to 52 | 38 to 52 | 38 to 52 | 38 to 52 | 38 to 52 |
| Order unit | PR | PR | PR | PR | PR | PR | PR | PR | PR |

Safety Footwear
uvex 2 xenova®



95561
95562
95563

95661
95662
95663

95071
95072
95073



climazone

uvex 2 xenova® · Lace-up boot S3 SRC

General features:

- extremely lightweight, versatile S3 lace-up safety boot
- upper over the toe cap lasts longer thanks to the PU-coated leather scuffcap
- all sole materials are free of silicones, plasticisers and other paint wetting impairment substances
- heat-resistant loop lacing system and two pairs of lacing hooks

Protection features:

- meets the ESD specifications with volume resistance under 35 megaohms
- 100% metal-free uvex xenova® safety toe cap – compact design, anatomical shape, good lateral stability, no thermal conductivity
- penetration-resistant, non-metallic midsole in accordance with the latest safety standards, does not restrict flexibility of the shoe
- ergonomically designed outsole made from dual density polyurethane with excellent slip resistance
- reflective elements for better visibility

Comfort features:

- lightweight with excellent shock-absorbing properties
- outstanding wearer comfort thanks to a newly developed last and climate-optimised, breathable materials
- removable antistatic comfortable insole, with a moisture transport system and additional shock absorption around the heel and forefoot
- soft padding on dust tongue and collar

Areas of application:

- medium applications



| uvex 2 xenova® | Lace-up boot S3 SRC | | | Lace-up boot S3 SRC | | | Lace-up boot S3 SRC | | |
|----------------|-------------------------------------|----------|----------|---------------------|----------|----------|---------------------|----------|----------|
| Art. no. | 95561 | 95562 | 95563 | 95661 | 95662 | 95663 | 95071 | 95072 | 95073 |
| Width | 10 | 11 | 12 | 10 | 11 | 12 | 10 | 11 | 12 |
| Standard | EN ISO 20345:2011 S3 SRC | | | | | | | | |
| Upper | water-repellent, full-grain leather | | | | | | | | |
| Lining | distance mesh lining | | | | | | | | |
| Sizes | 38 to 52 | 38 to 52 | 38 to 52 | 38 to 52 | 38 to 52 | 38 to 52 | 38 to 52 | 38 to 52 | 38 to 52 |
| Order unit | PR | PR | PR | PR | PR | PR | PR | PR | PR |

uvex

uvex 2 trend – safety and comfort redefined

Add a splash of colour to your day.

Whether in the assembly hall or on the production line, indoors or outdoors:

uvex 2 trend safety footwear range is suitable for medium applications (S1-S3) and incorporates numerous proven technologies at an affordable price. The uvex anti-twist heel cap for increased stability to prevent ankle twisting and the high-quality outsole materials combined with a sporty look and bold colours make this footwear appealing to wear. The result: maximum comfort and reliable safety.



Affordable Quality and Comfort

Sporty design

Contemporary colours and a long, flexible lacing area give the uvex 2 trend range a sporty look and a high degree of wearer acceptance.

Greater visibility

Reflective elements provide greater visibility – and therefore safety – even in poor light conditions.

Pleasant foot climate

The breathable, chrome-free microvelour material ensures a pleasant foot climate at all times, even during prolonged periods of use.



climazone



Orthopaedic solutions in accordance with German DGUV 112-191* and Austrian ONORM Z1259

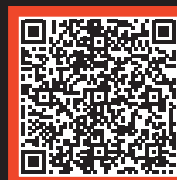

You can find more information at www.uvex-safety.com/uvex2trend



First-class wearer comfort

The midsole follows the lines of the arch, making the safety shoes especially comfortable to wear.



Safe slip resistance

The ergonomic design of the outsole supports the natural rolling motion of the foot. The new outsole profiles offer the best grip on almost any surface.



Sturdy scuffcap **

The directly moulded PU scuffcap on the S3 version reliably protects the upper against wear, especially during tasks that require kneeling.



Reliable protection against twisting

The innovative uvex anti-twist heel cap gives the foot extra support to avoid painful twisting.

* formerly BGR 191 ** on selected models



Safety Footwear

uvex 2 trend



69367
69368
69369



uvex 2 trend - Sandal S1 SRC

General features:

- sporty S1 safety sandal with a wide fit
- breathable microvelour is made from synthetic materials, so suitable for people allergic to chrome
- all sole materials are free of silicones, plasticisers and other paint wetting impairment substances
- double, individually adjustable counter-traction hook and loop straps

Protection features:

- meets the ESD specifications with volume resistance under 35 megaohms
- reliable protection for the wearer and material: steel toe cap and stabilising uvex anti-twist heel cap to prevent ankle twisting
- ergonomically designed outsole made from dual density polyurethane with excellent slip resistance
- reflective elements for better visibility

Comfort features:

- ideal foot climate constantly maintained due to uvex climazone: highly breathable lining and upper with perforation and comfortable climatic insole with moisture transport system
- soft, comfortable fit with no pressure points – with soft padding on the collar and a padded tongue
- removable antistatic comfortable insole, with a moisture transport system and additional shock absorption around the heel and forefoot

Areas of application:

- medium applications

| | | | |
|--------------|--------------------------|----------|----------|
| uvex 2 trend | Sandal S1 SRC | | |
| Art. no. | 69367 | 69368 | 69369 |
| Width | 10 | 11 | 12 |
| Standard | EN ISO 20345:2011 S1 SRC | | |
| Upper | microvelour | | |
| Lining | distance mesh lining | | |
| Sizes | 38 to 52 | 38 to 52 | 38 to 52 |
| Order unit | PR | PR | PR |

Safety Footwear

uvex 2 trend



69361
69362
69363

69061
69062
69063

69461
69462
69463



uvex 2 trend - Sandal S1 P SRC

General features:

- sporty S1 P safety sandal with a wide fit
- breathable microvelour is made from synthetic materials, so suitable for people allergic to chrome
- all sole materials are free of silicones, plasticisers and other paint wetting impairment substances
- double, individually adjustable counter-traction hook and loop straps

Protection features:

- meets the ESD specifications with volume resistance under 35 megaohms
- reliable protection for the wearer and material: penetration-resistant steel midsole, steel toe cap and stabilising uvex anti-twist heel cap to prevent ankle twisting
- ergonomically designed outsole made from dual density polyurethane with excellent slip resistance
- reflective elements for better visibility

Comfort features:

- ideal foot climate constantly maintained due to uvex climazone: highly breathable lining and upper with perforation and comfortable climatic insole with moisture transport system
- soft, comfortable fit with no pressure points – with soft padding on the collar and a padded tongue
- removable antistatic comfortable insole, with a moisture transport system and additional shock absorption around the heel and forefoot

Areas of application:

- medium applications



| uvex 2 trend | Sandal S1 P SRC | | | Sandal S1 P SRC | | | Sandal S1 P SRC | | |
|-------------------|----------------------------|----------|----------|-----------------|----------|----------|-----------------|----------|----------|
| Art. no. | 69361 | 69362 | 69363 | 69061 | 69062 | 69063 | 69461 | 69462 | 69463 |
| Width | 10 | 11 | 12 | 10 | 11 | 12 | 10 | 11 | 12 |
| Standard | EN ISO 20345:2011 S1 P SRC | | | | | | | | |
| Upper | microvelour | | | | | | | | |
| Lining | distance mesh lining | | | | | | | | |
| Sizes | 38 to 52 | 38 to 52 | 38 to 52 | 38 to 52 | 38 to 52 | 38 to 52 | 38 to 52 | 38 to 52 | 38 to 52 |
| Order unit | PR | PR | PR | PR | PR | PR | PR | PR | PR |

Safety Footwear

uvex 2 trend



69377
69378
69379

69077
69078
69079

69477
69478
69479



uvex 2 trend - Perforated shoe S1 SRC

General features:

- sporty S1 safety shoe with a wide fit
- breathable microvelour is made from synthetic materials, so suitable for people allergic to chrome
- all sole materials are free of silicones, plasticisers and other paint wetting impairment substances

Protection features:

- meets the ESD specifications with volume resistance under 35 megaohms
- reliable protection for the wearer and material: steel toe cap and stabilising uvex anti-twist heel cap to prevent ankle twisting
- ergonomically designed outsole made from dual density polyurethane with excellent slip resistance
- reflective elements for better visibility

Comfort features:

- ideal foot climate constantly maintained due to uvex climazone: highly breathable lining and upper with perforation and comfortable climatic insole with moisture transport system
- soft, comfortable fit with no pressure points – with soft padding on the collar and a padded tongue
- removable antistatic comfortable insole, with a moisture transport system and additional shock absorption around the heel and forefoot

Areas of application:

- medium applications

| uvex 2 trend | Perforated shoe S1 SRC | | | Perforated shoe S1 SRC | | | Perforated shoe S1 SRC | | |
|-------------------|--------------------------|----------|----------|------------------------|----------|----------|------------------------|----------|----------|
| Art. no. | 69377 | 69378 | 69379 | 69077 | 69078 | 69079 | 69477 | 69478 | 69479 |
| Width | 10 | 11 | 12 | 10 | 11 | 12 | 10 | 11 | 12 |
| Standard | EN ISO 20345:2011 S1 SRC | | | | | | | | |
| Upper | microvelour | | | | | | | | |
| Lining | distance mesh lining | | | | | | | | |
| Sizes | 38 to 52 | 38 to 52 | 38 to 52 | 38 to 52 | 38 to 52 | 38 to 52 | 38 to 52 | 38 to 52 | 38 to 52 |
| Order unit | PR | PR | PR | PR | PR | PR | PR | PR | PR |

Safety Footwear

uvex 2 trend



69381
69382
69383



69081
69082
69083



climazone BOA

uvex 2 trend - Perforated shoe S1 P SRC

General features:

- sporty S1 P safety sandal with a wide fit
- breathable microvelour is made from synthetic materials, so suitable for people allergic to chrome
- all sole materials are free of silicones, plasticisers and other paint wetting impairment substances
- Boa® Fit System (consisting of a micro-adjustable dial, super-strong lightweight laces and low friction lace guides) engineered to optimise fit and provide precision, adaptability, and control.

Protection features:

- meets the ESD specifications with volume resistance under 35 megohms
- reliable protection for the wearer and material: penetration-resistant steel midsole, steel toe cap and stabilising uvex anti-twist heel cap to prevent ankle twisting
- ergonomically designed outsole made from dual density polyurethane with excellent slip resistance
- reflective elements for better visibility

Comfort features:

- ideal foot climate constantly maintained due to uvex climazone: highly breathable lining and upper with perforation and comfortable climatic insole with moisture transport system
- soft, comfortable fit with no pressure points – with soft padding on the collar and a padded tongue
- removable antistatic comfortable insole, with a moisture transport system and additional shock absorption around the heel and forefoot

Areas of application:

- medium applications



| uvex 2 trend | Perforated shoe S1 P SRC | | | Perforated shoe S1 P SRC | | |
|-------------------|----------------------------|----------|----------|--------------------------|----------|----------|
| Art. no. | 69381 | 69382 | 69383 | 69081 | 69082 | 69083 |
| Width | 10 | 11 | 12 | 10 | 11 | 12 |
| Standard | EN ISO 20345:2011 S1 P SRC | | | | | |
| Upper | microvelour | | | | | |
| Lining | distance mesh lining | | | | | |
| Sizes | 38 to 52 | 38 to 52 | 38 to 52 | 38 to 52 | 38 to 52 | 38 to 52 |
| Order unit | PR | PR | PR | PR | PR | PR |

Safety Footwear

uvex 2 trend



69397
69398
69399



69097
69098
69099



69497
69498
69499



uvex 2 trend · Shoe S2 SRC

General features:

- sporty S2 safety shoe with a wide fit
- breathable microvelour is made from synthetic materials, so suitable for people allergic to chrome
- all sole materials are free of silicones, plasticisers and other paint wetting impairment substances

Protection features:

- meets the ESD specifications with volume resistance under 35 megohms
- reliable protection for the wearer and material: steel toe cap and stabilising uvex anti-twist heel cap to prevent ankle twisting
- ergonomically designed outsole made from dual density polyurethane with excellent slip resistance
- reflective elements for better visibility

Comfort features:

- ideal foot climate constantly maintained due to uvex climazone: highly breathable lining and upper, and comfortable climatic insole with moisture transport system
- soft, comfortable fit with no pressure points – with soft padding on the collar and a padded tongue
- removable antistatic comfortable insole, with a moisture transport system and additional shock absorption around the heel and forefoot

Areas of application:

- medium applications

| uvex 2 trend | Shoe S2 SRC | | | Shoe S2 SRC | | | Shoe S2 SRC | | |
|-------------------|--------------------------|----------|----------|-------------|----------|----------|-------------|----------|----------|
| Art. no. | 69397 | 69398 | 69399 | 69097 | 69098 | 69099 | 69497 | 69498 | 69499 |
| Width | 10 | 11 | 12 | 10 | 11 | 12 | 10 | 11 | 12 |
| Standard | EN ISO 20345:2011 S2 SRC | | | | | | | | |
| Upper | microvelour | | | | | | | | |
| Lining | distance mesh lining | | | | | | | | |
| Sizes | 38 to 52 | 38 to 52 | 38 to 52 | 38 to 52 | 38 to 52 | 38 to 52 | 38 to 52 | 38 to 52 | 38 to 52 |
| Order unit | PR | PR | PR | PR | PR | PR | PR | PR | PR |

Safety Footwear

uvex 2 trend



69341
69342
69343

69347
69348
69349

69351
69352
69353

69357
69358
69359



uvex 2 trend · Shoe S2/S3 SRC · Lace-up boot S2/S3 SRC

General features:

- sporty S2 and S3 safety shoe/boot with a wide fit
- all sole materials are free of silicones, plasticisers and other paint wetting impairment substances
- dirt-resistant, smooth-running and heat-resistant lacing system
- upper over the toe cap is protected by the foamed scuffcap (S3 models)

Protection features:

- meets the ESD specifications with volume resistance under 35 megaohms
- reliable protection for the wearer and material: penetration-resistant steel midsole (S3 models), steel toe cap and stabilising uvex anti-twist heel cap to prevent ankle twisting
- ergonomically designed outsole made from dual density polyurethane with excellent slip resistance
- reflective elements for better visibility

Comfort features:

- ideal foot climate constantly maintained due to uvex climazone: highly breathable lining and upper, and comfortable climatic insole with moisture transport system
- soft, comfortable fit with no pressure points – with soft padding on the collar and a padded tongue
- removable antistatic comfortable insole, with a moisture transport system and additional shock absorption around the heel and forefoot

Areas of application:

- medium applications



| | | | | | | |
|--------------|--------------------------|----------|----------|--------------------------|----------|----------|
| uvex 2 trend | Shoe S2 SRC | | | Lace-up boot S2 SRC | | |
| Art. no. | 69347 | 69348 | 69349 | 69357 | 69358 | 69359 |
| Width | 10 | 11 | 12 | 10 | 11 | 12 |
| Standard | EN ISO 20345:2011 S2 SRC | | | EN ISO 20345:2011 S2 SRC | | |
| Upper | Full-grain soft leather | | | Full-grain soft leather | | |
| Lining | distance mesh lining | | | distance mesh lining | | |
| Sizes | 38 to 52 | 38 to 52 | 38 to 52 | 38 to 52 | 38 to 52 | 38 to 52 |
| Order unit | PR | PR | PR | PR | PR | PR |

| | | | | | | |
|--------------|--------------------------|----------|----------|--------------------------|----------|----------|
| uvex 2 trend | Shoe S3 SRC | | | Lace-up boot S3 SRC | | |
| Art. no. | 69341 | 69342 | 69343 | 69351 | 69352 | 69353 |
| Width | 10 | 11 | 12 | 10 | 11 | 12 |
| Standard | EN ISO 20345:2011 S3 SRC | | | EN ISO 20345:2011 S3 SRC | | |
| Upper | Full-grain soft leather | | | Full-grain soft leather | | |
| Lining | distance mesh lining | | | distance mesh lining | | |
| Sizes | 38 to 52 | 38 to 52 | 38 to 52 | 38 to 52 | 38 to 52 | 38 to 52 |
| Order unit | PR | PR | PR | PR | PR | PR |

Safety Footwear

uvex xenova® hygiene



69278



69608



uvex xenova® hygiene · Shoe S1 SRC

General features:

- low weight metal-free S1 safety shoe
- upper made from splashproof microfibre material that is easy to clean, completely closed around the forefoot to protect against moisture penetration
- made from synthetic materials, so suitable for people allergic to chrome
- quick-action plastic fastener with hook-and-loop strap for individual adjustment

Protection features:

- meets the ESD specification with volume resistance under 35 megaohms
- 100% metal-free uvex xenova® toe cap – compact design, anatomical shape, good lateral stability, no thermal conductivity
- self-cleaning, lightweight PU outsole with optimal abrasion resistance, shock absorption and excellent slip resistance

Comfort features:

- lightweight and excellent shock absorption – optimal shock absorption in the heel and forefoot with the uvex 3D hydroflex® foam insole
- ideal foot climate constantly maintained due to uvex climazone: particularly breathable lining and upper and comfortable climatic insole with a moisture transport system
- side openings to make the shoe more breathable
- soft padding on collar and tongue

Areas of application:

- medium applications

| | |
|----------------------------------|--------------------------|
| uvex xenova® hygiene Shoe S1 SRC | |
| Art. no. | 69278 |
| Width | 11 |
| Standard | EN ISO 20345:2011 S1 SRC |
| Upper | microfibres |
| Lining | textile lining |
| Sizes | 36 to 50 |
| Order unit | PR |

uvex xenova® hygiene · Slingback SB A E FO SRC

General features:

- low weight safety shoe SB as slingback
- upper made from splashproof microfibre material that is easy to clean, completely closed around the forefoot to protect against moisture penetration
- minimal number of seams to reduce contamination
- made from synthetic materials, so suitable for people allergic to chrome
- all sole materials are free of silicones, plasticisers and other paint wetting impairment substances

Protection features:

- meets the ESD specification with volume resistance under 35 megaohms
- 100% metal-free uvex xenova® toe cap – compact design, anatomical shape, good lateral stability, no thermal conductivity
- self-cleaning, lightweight PU outsole with optimal abrasion resistance, shock absorption and excellent slip resistance

Comfort features:

- lightweight and excellent shock absorption – optimal shock absorption in the heel and forefoot with uvex 3D hydroflex® foam insole
- ideal foot climate constantly maintained due to uvex climazone: particularly breathable lining and upper and comfortable climatic insole with a moisture transport system
- soft padding on collar

Areas of application:

- medium applications

| | |
|--|---------------------------------|
| uvex xenova® hygiene Slingback SB A E FO SRC | |
| Art. no. | 69608 |
| Width | 11 |
| Standard | EN ISO 20345:2011 SB A E FO SRC |
| Upper | microfibres |
| Lining | textile lining |
| Sizes | 36 to 50 |
| Order unit | PR |

Safety Footwear

uvex xenova® hygiene



69628



69648



69658



uvex xenova® hygiene · Shoe S2 SRC

General features:

- low weight metal-free S2 safety shoe and slip-on shoe
- upper made from splashproof microfibre material that is easy to clean
- minimal number of seams to reduce contamination
- made from synthetic materials, so suitable for people allergic to chrome
- all sole materials are free of silicones, plasticisers and other paint wetting impairment substances

Protection features:

- meets the ESD specification with volume resistance under 35 megaohms
- 100% metal-free uvex xenova® toe cap – compact design, anatomical shape, good lateral stability, no thermal conductivity
- self-cleaning, lightweight PU outsole with optimal abrasion resistance, shock absorption and excellent slip resistance

Comfort features:

- low weight and excellent shock absorption – optimal shock absorption in the heel and forefoot together with uvex 3D hydroflex® foam insole
- ideal foot climate constantly maintained due to uvex climazone: highly breathable lining and upper and comfortable climatic insole with a moisture transport system
- soft padding on collar and tongue

Areas of application:

- medium applications

| uvex xenova® hygiene | Shoe S2 SRC | Shoe S2 SRC | Shoe S2 SRC |
|----------------------|--------------------------|--------------------------|--------------------------|
| Art. no. | 69628 | 69648 | 69658 |
| Width | 11 | 11 | 11 |
| Standard | EN ISO 20345:2011 S2 SRC | EN ISO 20345:2011 S2 SRC | EN ISO 20345:2011 S2 SRC |
| Upper | microfibres | microfibres | microfibres |
| Lining | textile lining | textile lining | textile lining |
| Sizes | 36 to 50 | 36 to 50 | 36 to 50 |
| Order unit | PR | PR | PR |



uvex

uvex quatro GTX

Extremely robust.
Even in wet conditions.



GORE-TEX® Extended Comfort Footwear¹

- permanently waterproof and highly breathable
- maximum heat dissipation

Dry and comfortable at high temperatures.



Feet remain dry even under extreme conditions: The uvex quatro GTX reliably prevents the penetration of water thanks to its GORE-TEX® membrane, at the same time ensuring a superior foot climate due to the high level of breathability – the perfect combination between protection and wearer comfort.

uvex quatro GTX sole

- dual component PU / rubber sole for outdoor use
- outstanding comfort underfoot thanks to ultra soft, shock-absorbing midsole and non-slip rubber outsole
- extremely cut-resistant

- temperature-resistance of outsole for brief exposure up to +300°C
- suitable for general use on almost all surfaces and in a very broad temperature range of -20°C for brief exposure up to +300°C
- resistant to most chemicals

- excellent slip resistance even on damp and oily surfaces
- antistatic
- HI, CI, HRO, SRC



Safety Footwear

uvex quatro GTX



84042



84052



climazone

uvex quatro GTX · Shoe S3 WR CI HI HRO SRC · Lace-up boot S3 WR CI HI HRO SRC

General features:

- robust, modern waterproof shoe / lace-up boot in S3 WR with extra wide fit
- smooth-running, dirt-resistant lacing system
- highly resistant, water-repellent upper leather with foam scuffcap helps protect the upper

Protection features:

- 100% waterproof thanks to GORE-TEX® lining (WR label)
- dual-component sole, comprising shock-absorbing PU midsole and resistant, anti-slip rubber outsole
- outsole largely resistant to chemicals, highly cut-resistant and offering optimum protection against heat and cold
- reliable protection for wearers: penetration-resistant steel midsole, steel toe cap and the stabilising heel cap to prevent ankle twisting
- HI label for heat-insulating substructure (tested in accordance with standard at +150°C)
- CI label for cold-insulating footwear design
- HRO label for heat-resistant substructure for brief exposure up to +300°C

Comfort features:

- foot climate constantly maintained thanks to uvex climazone: breathable GORE-TEX® textile lining, and comfortable climatic insole with a moisture transport system
- breathable yet waterproof thanks to GORE-TEX® lining
- soft, padded collar (boot), soft padding on collar and dust tongue (shoe)
- removable, antistatic insole for optimum foot support

Areas of application:

- heavy applications



| uvex quatro GTX | Shoe S3 WR CI HI HRO SRC | Lace-up boot S3 WR CI HI HRO SRC |
|-------------------|---------------------------------------|---------------------------------------|
| Art. no. | 84042 | 84052 |
| Width | 11 | 11 |
| Standard | EN ISO 20345:2011 S3 WR CI HI HRO SRC | EN ISO 20345:2011 S3 WR CI HI HRO SRC |
| Upper | sturdy water-repellent nappa leather | sturdy water-repellent nappa leather |
| Lining | GORE-TEX® laminate | GORE-TEX® laminate |
| Sizes | 38 to 48 | 38 to 48 |
| Order unit | PR | PR |

► **uvex recommends footwear with steel midsoles for demanding applications such as construction and construction-related industries.**

GORE-TEX® is a registered trademark of W. L. GORE & Associates.

Safety Footwear

uvex quatro pro



84002



84012



uvex quatro pro sole



climazone

uvex quatro pro · Shoe S3 SRC · Lace-up boot S3 SRC

General features:

- sturdy, modern shoe and lace-up boot with extra wide fit
- smooth-running, dirt-resistant lacing system

Protection features:

- highly resistant, water-repellent upper leather with foam scuffcap helps protect the upper
- outdoor sole design provides a high level of stability with a heel brace, support in the arch area and a rough, non-slip, self-cleaning tread
- reliable protection for wearers: penetration-resistant steel midsole, steel toe cap and stabilising uvex anti-twist heel cap to prevent ankle twisting

Comfort features:

- ideal foot climate constantly maintained due to uvex climazone: breathable textile lining and comfortable climatic insole with a moisture transport system
- soft, padded collar and padded dust tongue
- antistatic uvex 3D hydroflex® foam insole for optimal shock absorption around heel and forefoot

Areas of application:

- heavy application

uvex quatro pro · sole

- dual-density PU outdoor sole
- extremely comfortable underfoot due to particularly soft midsole and stable PU outsole
- highly effective non-slip properties due to special tread design
- support in the arch area when climbing
- integrated PU scuffcap and PU heel cap to protect leather upper
- side stabilisers to prevent ankle twisting
- outsole is heat-resistant to +120 °C
- antistatic
- oil and petrol-resistant
- silicone-free
- self-cleaning tread

► **uvex recommends footwear with steel midsoles for demanding applications such as construction and construction-related industries.**

| uvex quatro pro | Shoe S3 SRC | Lace-up boot S3 SRC |
|-------------------|--------------------------------------|--------------------------------------|
| Art. no. | 84002 | 84012 |
| Width | 11 | 11 |
| Standard | EN ISO 20345:2011 S3 SRC | EN ISO 20345:2011 S3 SRC |
| Upper | sturdy water-repellent leather upper | sturdy water-repellent leather upper |
| Lining | textile lining | textile lining |
| Sizes | 38 to 50 | 38 to 50 |
| Order unit | PR | PR |

Safety Footwear
uvex quatro pro



84022



84032

84039



climazone

uvex quatro pro · Winter lace-up boot S3 CI SRC · Winter zip-up boot S3 CI SRC/S2 CI SRC

General features:

- sturdy, modern S2/S3 CI winter lace-up boot and zip-up boot with extra wide fit
- smooth-running, dirt-resistant lacing system (84022)

Protection features:

- highly resistant, water-repellent leather upper with foam scuffcap helps protect the upper
- outdoor sole design provides a high level of stability with a heel brace, support in the arch area and a rough, non-slip, self-cleaning tread
- reliable protection for people and material: penetration-resistant steel midsole (on S3 models), steel toe cap and stabilising uvex anti-twist heel cap help prevent ankle twisting
- cold-insulating shoe design (CI label in accordance with EN ISO 20345)

Comfort features:

- ideal foot climate constantly maintained due to uvex climazone: insulating warm lining and comfortable climatic insole with moisture transport system
- soft, padded collar and dust tongue (84022)
- easy to put on and take off with the zip fastener on the inside (84032, 84039)
- antistatic uvex 3D hydroflex® foam insole for optimal shock absorption around the heel and forefoot

Areas of application:

- heavy application



► **uvex recommends footwear with steel midsoles for demanding applications such as construction and construction-related industries.**

| uvex quatro pro | Winter lace-up boot S3 CI SRC | Zip-up winter boot S3 CI SRC | Zip-up winter boot S2 CI SRC |
|-------------------|--------------------------------------|--------------------------------------|--------------------------------------|
| Art. no. | 84022 | 84032 | 84039 |
| Width | 11 | 11 | 11 |
| Standard | EN ISO 20345:2011 S3 CI SRC | EN ISO 20345:2011 S3 CI SRC | EN ISO 20345:2011 S2 CI SRC |
| Upper | sturdy water-repellent leather upper | sturdy water-repellent leather upper | sturdy water-repellent leather upper |
| Lining | fleece lining | fleece lining | fleece lining |
| Sizes | 38 to 50 | 38 to 50 | 38 to 50 |
| Order unit | PR | PR | PR |

Safety Footwear

uvex offroad construction



85983



85993



uvex offroad construction · Shoe S3 SRC · Lace-up boot S3 SRC

General features:

- robust, modern shoe or lace-up boot
- smooth-running, dirt-resistant lacing system

Protection features:

- highly resistant, water-repellent leather upper with foam scuffcap that also helps protect the material
- outdoor sole design with support in the arch area and rough, non-slip and self-cleaning tread
- reliable protection for wearers and materials: penetration-resistant steel midsole and 100% metal-free toe cap
- Reflective element for better visibility

Comfort features:

- breathable textile lining
- removable, antistatic insole
- soft, padded collar (boot), soft padding on collar and dust tongue (shoe)
- TPU part on the heel for easy removal of the shoe

Areas of application:

- heavy applications

Description of the sole:

- dual-density PU outdoor sole
- extremely comfortable walking thanks to soft midsole and stable PU outsole
- support in the arch area and integrated PU scuffcap to protect the leather upper
- outsole is heat-resistant to +120°C
- antistatic
- oil and petrol-resistant
- self-cleaning tread

► uvex recommends footwear with steel midsoles for demanding applications such as construction and construction-related industries.

| uvex offroad construction | Shoe S3 SRC | Lace-up Boot S3 SRC |
|---------------------------|--------------------------------------|--------------------------------------|
| Art. no. | 85983 | 85993 |
| Width | 11 | 11 |
| Standard | EN ISO 20345:2011 S3 SRC | EN ISO 20345:2011 S3 SRC |
| Upper | sturdy water-repellent leather upper | sturdy water-repellent leather upper |
| Lining | textile lining | textile lining |
| Sizes | 35 to 50 | 35 to 50 |
| Order unit | PR | PR |

Safety Footwear

uvex motion 3XL



64963



uvex motion 3XL · Shoe S3 SRC

General features:

- extremely wide innovative shoe
- made from synthetic textiles, so suitable for people allergic to chrome
- variable PU outsole individually adjustable to a range of protective modifications
- ample room for individually adapted insole for diabetic wearers

Protection features:

- meets the ESD specification with volume resistance under 35 megaohms
- 100% metal-free uvex xenova® toe cap means the entire shoe is neither thermally conductive nor magnetic
- penetration-resistant, non-metallic midsole in accordance with the latest safety standards, does not restrict flexibility of the shoe
- extended uvex anti-twist heel cap significantly increases stability and offers improved protection from ankle twisting

Comfort features:

- virtually seam-free construction from high-tech microvelour material to eliminate pressure points
- soft padding on collar and padded dust tongue
- elastic laces for quick, individual adjustment
- individually changeable antistatic EVA insole



| | |
|-----------------|--------------------------|
| uvex motion 3XL | Shoe S3 SRC |
| Art. no. | 64963 |
| Width | > 15 |
| Standard | EN ISO 20345:2011 S3 SRC |
| Upper | microvelour |
| Lining | distance mesh lining |
| Sizes | 35 to 50 |
| Order unit | PR |

► Further information on this product can be found on pages 416 to 421

Safety Footwear

Accessories · Inlay soles



 **LOW**
 Art. no. 95281
 Art. no. 95284
 Art. no. 95287
 Sizes 35 to 52

 **MEDIUM**
 Art. no. 95282
 Art. no. 95285
 Art. no. 95288
 Sizes 35 to 52

 **HIGH**
 Art. no. 95283
 Art. no. 95286
 Art. no. 95289
 Sizes 35 to 52



climazone

Comfortable tune-up

Antistatic insole concept for use in safety footwear. Designed to increase wearer comfort and enhance ergonomics by providing optimum support for the arches of the feet, helping to reduce foot fatigue.

- three different arch support versions: High, Medium, Low
- very good cushioning for comfort underfoot
- reduces symptoms of fatigue
- prevents pressure points
- non-irritating, comfortable surface structure
- breathable and absorbs moisture
- anti-bacterial
- antistatic
- suitable for ESD footwear
- hand-washable at 30°C
- certified for use in the following uvex safety shoes in accordance with EN ISO 20345:2011: uvex 1, uvex 1 G2, uvex 2, uvex 2 VIBRAM®, uvex 2 xenova®

| Comfortable tune-up | | | |
|---------------------|---|---|---|
| Art. no. | 95281 | 95282 | 95283 |
| Sizes | 35 to 52 | 35 to 52 | 35 to 52 |
| Version | certified for the following uvex safety footwear in accordance with EN ISO 20345:2011: uvex 1, uvex 2, uvex 2 VIBRAM®, uvex 2 xenova® | certified for the following uvex safety footwear in accordance with EN ISO 20345:2011: uvex 1, uvex 2, uvex 2 VIBRAM®, uvex 2 xenova® | certified for the following uvex safety footwear in accordance with EN ISO 20345:2011: uvex 1, uvex 2, uvex 2 VIBRAM®, uvex 2 xenova® |
| Order unit | PR | PR | PR |

| Comfortable tune-up | | | |
|---------------------|---|---|---|
| Art. no. | 95284 | 95285 | 95286 |
| Sizes | 35 to 52 | 35 to 52 | 35 to 52 |
| Version | certified for the following uvex safety footwear in accordance with EN ISO 20345:2011: uvex 1 sport | certified for the following uvex safety footwear in accordance with EN ISO 20345:2011: uvex 1 sport | certified for the following uvex safety footwear in accordance with EN ISO 20345:2011: uvex 1 sport |
| Order unit | PR | PR | PR |

| Comfortable tune-up | | | |
|---------------------|--|--|--|
| Art. no. | 95287 | 95288 | 95289 |
| Sizes | 35 to 52 | 35 to 52 | 35 to 52 |
| Version | certified for the following uvex safety footwear in accordance with EN ISO 20345:2011: uvex 1 G2 | certified for the following uvex safety footwear in accordance with EN ISO 20345:2011: uvex 1 G2 | certified for the following uvex safety footwear in accordance with EN ISO 20345:2011: uvex 1 G2 |
| Order unit | PR | PR | PR |

Safety Footwear

Accessories · Inlay soles



Comfortable climatic insole uvex 1 · uvex 2 · uvex 2 VIBRAM® · uvex 2 xenova®

- full-surface shock absorption
- ultra breathable and moisture-absorbing materials
- perforated for improved breathability
- shock absorption zones support natural foot movement
- non-irritating, comfortable surface structure
- antistatic properties
- arch support

| Comfortable climatic insole uvex 1, uvex 2, uvex 2 VIBRAM®, uvex 2 xenova® | | | | |
|--|----------------------------|----------------------------|----------------------------|--|
| Art. no. | 95347 | 95348 | 95349 | 95340 |
| Sizes | 35 to 52 | 35 to 52 | 35 to 52 | 35 to 52 |
| Version | for uvex 1, uvex 2, uvex 2 | for uvex 1, uvex 2, uvex 2 | for uvex 1, uvex 2, uvex 2 | for uvex 1, uvex 2, uvex 2 VIBRAM® |
| | VIBRAM®, width 10 | VIBRAM®, width 11 | VIBRAM®, width 12 | VIBRAM®, width 14 |
| | uvex 2 xenova® | uvex 2 xenova® | uvex 2 xenova® | uvex 2 xenova® not suitable for subsequent adjustments, only available for shoes in width 14 |
| Order unit | PR | PR | PR | PR |

Comfortable climatic insole uvex 1 G2

- improved full-surface shock absorption
- ultra-breathable, moisture-absorbing and quick-drying materials
- shock absorption zones support natural movement of the foot
- non-irritating, comfortable surface structure
- antistatic properties
- arch support
- washable, hand wash at 30°C

| Comfortable climatic insole uvex 1 G2 | | | | |
|---------------------------------------|---------------|---------------|---------------|---|
| Art. no. | 94907 | 94908 | 94909 | 94900 |
| Sizes | 35 to 52 | 35 to 52 | 35 to 52 | 35 to 52 |
| Version | for uvex 1 G2 | for uvex 1 G2 | for uvex 1 G2 | for uvex 1 G2 |
| | Width 10 | Width 11 | Width 12 | Width 14 |
| | | | | not suitable for subsequent adjustments, only available for shoes in width 14 |
| Order unit | PR | PR | PR | PR |

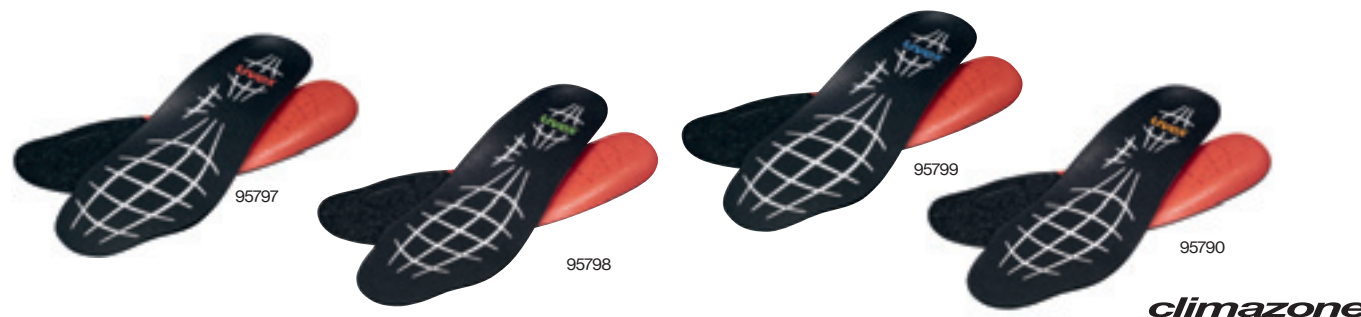

Comfortable climatic insole uvex 1 sport

- full-surface shock absorption
- ultra breathable and moisture-absorbing materials
- shock absorption zones support natural foot movement
- non-irritating, comfortable surface structure
- antistatic properties
- arch support

| Comfortable climatic insole uvex 1 sport | | | | |
|--|------------------|------------------|------------------|------------------|
| Art. no. | 95797 | 95798 | 95799 | 95790 |
| Sizes | 35 to 52 | 35 to 52 | 35 to 52 | 35 to 52 |
| Version | for uvex 1 sport | for uvex 1 sport | for uvex 1 sport | for uvex 1 sport |
| | Width 10 | Width 11 | Width 12 | Width 14 |
| Order unit | PR | PR | PR | PR |



Safety Footwear

Accessories · Inlay soles



climazone

Comfortable climatic insole uvex 1 business

- full-surface shock absorption
- ultra breathable and moisture-absorbing materials
- shock absorption zones support natural foot movement
- non-irritating, comfortable surface structure
- antistatic properties
- arch support

| Comfortable climatic insole uvex 1 business | | | |
|---|---------------------|---------------------|---------------------|
| Art. no. | 95157 | 95158 | 95159 |
| Sizes | 39 to 52 | 39 to 52 | 39 to 52 |
| Version | for uvex 1 business | for uvex 1 business | for uvex 1 business |
| | Width 10 | Width 11 | Width 12 |
| Order unit | PR | PR | PR |



climazone

Comfortable climatic insole uvex 1 sport NC

- full-surface shock absorption
- ultra breathable and moisture-absorbing materials
- shock absorption zones support natural foot movement
- non-irritating, comfortable surface structure
- antistatic properties
- arch support

| Comfortable climatic insole uvex 1 sport NC | | | |
|---|---------------------|---------------------|---------------------|
| Art. no. | 95177 | 95178 | 95179 |
| Sizes | 35 to 52 | 35 to 52 | 35 to 52 |
| Version | for uvex 1 sport NC | for uvex 1 sport NC | for uvex 1 sport NC |
| | Width 10 | Width 11 | Width 12 |
| Order unit | PR | PR | PR |



Comfortable climatic insole uvex 2 trend

- full-surface shock absorption
- ultra breathable and moisture-absorbing materials
- shock absorption zones support natural foot movement
- non-irritating, comfortable surface structure
- antistatic properties
- arch support

| Comfortable climatic insole uvex 2 trend | | | |
|--|------------------|------------------|------------------|
| Art. no. | 95187 | 95188 | 95189 |
| Sizes | 38 to 52 | 38 to 52 | 38 to 52 |
| Version | for uvex 2 trend | for uvex 2 trend | for uvex 2 trend |
| | Width 10 | Width 11 | Width 12 |
| Order unit | PR | PR | PR |

► For precise information on the certification of certain replacement insole and safety footwear combinations, please turn to the detailed overview on pages 350 to 355

Safety Footwear

Accessories · Inlay soles



95954
95956

climazone

Comfortable climatic insole uvex 3D hydroflex® foam

- full shock absorption for the foot with additional shock-absorbing elements around the heel and under the forefoot to ensure comfort in exposed pressure zones
- ultra breathable and moisture-absorbent materials
- perforation for improved breathability
- shock absorption zones support natural foot movement
- non-irritating, comfortable surface structure
- antistatic properties
- arch support

| | | |
|---|-------------------------------------|--|
| Comfortable climatic insole uvex 3D hydroflex® foam | | |
| Art. no. | 95954 | 95956 |
| Sizes | 38 to 50 | 35 to 50 |
| Version | for uvex origin and uvex quatro pro | for uvex motion style, uvex xenova® hygiene width 11 |
| Order unit | PR | PR |



95950

climazone

Comfortable climatic insole uvex hydroflex® GEL

- very high capacity to absorb and transport moisture for a balanced shoe climate
- uvex hydroflex® GEL, visible from above, for even more effective shock absorption
- shock absorption system directly beneath the heel bone
- antistatic properties
- arch support

| | |
|---|--|
| Comfortable climatic insole uvex hydroflex® GEL | |
| Art. no. | 95950 |
| Sizes | 36 to 48 |
| Version | approved for the uvex motorsport product range |
| Order unit | PR |



95388

climazone

Comfortable climatic insole

- full-surface shock absorption
- ultra breathable and moisture-absorbing materials
- perforated for improved breathability
- shock absorption zones support natural foot movement
- non-irritating, comfortable surface structure
- antistatic properties
- arch support

| | |
|-----------------------------|--------------------------|
| Comfortable climatic insole | |
| Art. no. | 95388 |
| Sizes | 38 to 48 |
| Version | for uvex business casual |
| Order unit | PR |



95370

climazone

Comfortable climatic insole

- ultra breathable and moisture-absorbing materials
- non-irritating, comfortable surface structure
- antistatic properties

| | |
|-----------------------------|-------------------------------|
| Comfortable climatic insole | |
| Art. no. | 95370 |
| Sizes | 35 to 48 |
| Version | for uvex offroad construction |
| Order unit | PR |



Safety Footwear

uvex care system



uvex nano shoe add on

footwear waterproofing for protection against moisture penetration and stains

The principle

Water-based uvex nano shoe "add on" waterproofing forms a colourless, invisible film on leather and textile surfaces which protects footwear from moisture penetration and water or oil stains. Although the technological expertise owes its origins to chemical nanotechnology, the product contains no actual nano particles. uvex nano shoe 'add on' makes footwear surfaces smooth so, that liquids simply run off. It does not alter the look or breathability of the impregnated material, irrespective of whether this is suede,

leather or textile. Contains no aggressive ingredients which might attack footwear surfaces.

How it works

- Protects from moisture penetration:
The speed at which moisture penetrates leather or textile surfaces which have been treated is significantly reduced. Water and oil simply run off.
- Maintains breathability:
uvex nano shoe 'add on' waterproofing does not affect the breathability of footwear surface materials.
- Improves cleaning
Footwear surfaces impregnated with uvex nano shoe 'add on' can be more easily cleaned, since water and oil stains cannot penetrate deep into the fabric.
- Long-lasting stain prevention:
Regular applications will significantly reduce repeated staining from water or oil-based liquids.

- No change to the look or feel of the surface:

The look or feel of footwear is not altered by the neutral uvex nano shoe 'add on' waterproofing. uvex nano shoe 'add on' is free from formaldehyde and phenol and contains no nano particles.

Application

- Clean leather and textile surfaces thoroughly beforehand
- Shake solution before use, then spray onto material to form a thin film over the surface (avoid drips forming)
- If necessary, wipe over excess liquid with a cloth to spread evenly
- Leave to dry at room temperature for at least 12 hours
- Repeat treatment as above when needed to maintain the effect

The nano shoe add on working principle

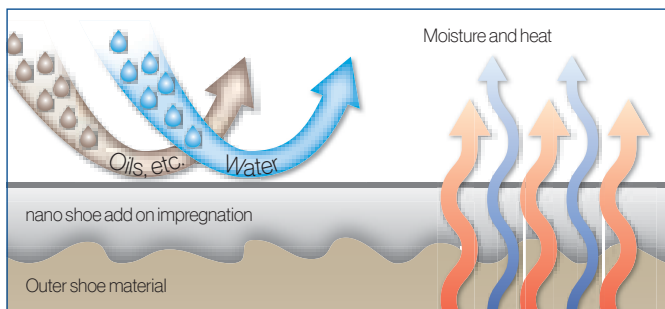

| |
|-----------------------|
| uvex nano shoe add on |
| Art. no. 9698100 |
| Content 100 ml |
| Order unit PC |



uvex nano shoe add in:

footwear disinfectant against foot odour and athlete's foot

The principle

uvex nano shoe 'add in' uses specially developed technology which releases controlled doses of active ingredients with long-lasting effect: The uvex nano shoe 'add in' disinfectant contains antimicrobial and antifungal active ingredients which eliminate bacteria and fungus over the longer term. Although this expertise owes its origins to chemical nanotechnology, the uvex nano shoe

'add in' does not contain any actual nano particles: The formula contains only active ingredients which are approved for use for a number of years and can be found in cosmetics (formaldehyde-free, phenol-free).

How it works

- Odour prevention:
Regular application of uvex nano shoe 'add in' in new shoes will prevent any build-up of odour from the outset. Unlike deodorants, which simply cover sweaty smells, this product deals with the underlying causes: bacteria.
- Ongoing deodorization:
Application of uvex nano shoe 'add in' will return footwear that has already been well worn to odour-neutral conditions.

- Kills fungi:
Filamentous or yeast fungi are among the most common causes of skin diseases (such as athlete's foot) affecting the feet. uvex nano shoe 'add in' kills existing fungi and prevents reoccurrence.

Application

- For use on the inside surfaces of all footwear
- Spray uvex nano shoe 'add in' (about 5-10 doses) into your footwear outside in the open air. After 15 minutes drying time, your shoes will be ready to wear
- Recommended initial treatment of badly affected footwear: three applications per week
- Regular use will prevent odours and fungus developing in the longer term

The nano shoe add in working principle
Controlled release of germicidal agents to protect against foot odour and athletes foot

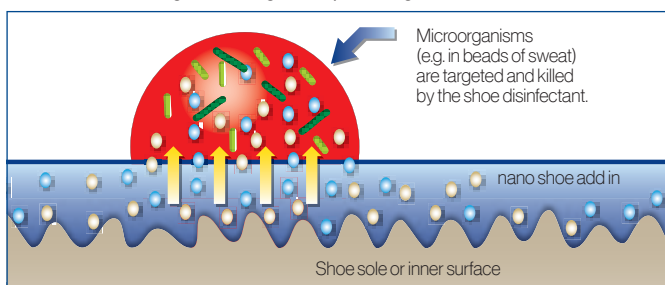

| |
|-----------------------|
| uvex nano shoe add in |
| Art. no. 9698300 |
| Content 125 ml |
| Order unit PC |

Safety Footwear

Polymer boot · Accessories



94756



94766



98754

NORA safety boots S5 SRC

General features:

- long PVC safety boot

Protection features:

- free of plasticisers included on the SVHC Candidate List of the REACH Regulation
- resistant to oil, grease, fuel, alkalis, acids and disinfectants
- with steel toecap and midsole
- toe and heel reinforcements plus ankle protection
- antistatic

Comfort features:

- anatomically shaped lasts, prevent foot fatigue
- leg height 33 cm (for size 42 boot)
- long shaft, can be shortened
- anatomically shaped insole
- pull-off aid

uvex tricort liner socks

- kind to the skin
- extremely high level of moisture absorption
- washable at up to 30 °C
- elastic



| | | |
|--------------------------|--------------------------|--------------------------|
| NORA safety boots S5 SRC | | |
| Art. no. | 94756 | 94766 |
| Standard | EN ISO 20345:2011 S5 SRC | EN ISO 20345:2011 S5 SRC |
| Upper | PVC | PVC |
| Sizes | 37 to 48 | 36 to 47 |
| Order unit | PR | PR |

| | |
|--------------------------|----------------|
| uvex tricort liner socks | |
| Art. no. | 98754 |
| Sizes | 39/40 to 47/48 |
| Order unit | PR |

| Art. no. | Collection | EN ISO 20345 | Sizes | Product | Replacement insole | | | | | | | | | | | Page | |
|----------|-----------------------|--------------|----------|---|--------------------|---------------|----------------------|----------------|----------------------|-----|-----------------|---------------|--------------|-----------|-----|------|-----|
| | | | | | | steel midsole | uvex xenova® midsole | uvex climazone | uvex xenova® toe cap | ESD | lacquer-neutral | uvex medicare | ÖNorm Z 1259 | GORE-TEX® | BOA | | |
| 95569 | uvex 2 xenova® | S2 SRC | 38 to 52 | Lace-up boot, width 12 | 95349 | | | | | | | | | | | | 325 |
| 95577 | uvex 2 xenova® | S2 SRC | 38 to 52 | Shoe, width 10 | 95347 | | | | | | | | | | | | 323 |
| 95578 | uvex 2 xenova® | S2 SRC | 38 to 52 | Shoe, width 11 | 95348 | | | | | | | | | | | | 323 |
| 95579 | uvex 2 xenova® | S2 SRC | 38 to 52 | Shoe, width 12 | 95349 | | | | | | | | | | | | 323 |
| 95581 | uvex 2 xenova® | S1 P SRC | 38 to 52 | Perforated Shoe, width 10 | 95347 | | | | | | | | | | | | 322 |
| 95582 | uvex 2 xenova® | S1 P SRC | 38 to 52 | Perforated Shoe, width 11 | 95348 | | | | | | | | | | | | 322 |
| 95583 | uvex 2 xenova® | S1 P SRC | 38 to 52 | Perforated Shoe, width 12 | 95349 | | | | | | | | | | | | 322 |
| 95591 | uvex 2 xenova® | S1 P SRC | 38 to 52 | Sandal, width 10 | 95347 | | | | | | | | | | | | 320 |
| 95592 | uvex 2 xenova® | S1 P SRC | 38 to 52 | Sandal, width 11 | 95348 | | | | | | | | | | | | 320 |
| 95593 | uvex 2 xenova® | S1 P SRC | 38 to 52 | Sandal, width 12 | 95349 | | | | | | | | | | | | 320 |
| 95597 | uvex 2 xenova® | S1 SRC | 38 to 52 | Sandal, width 10 | 95347 | | | | | | | | | | | | 319 |
| 95598 | uvex 2 xenova® | S1 SRC | 38 to 52 | Sandal, width 11 | 95348 | | | | | | | | | | | | 319 |
| 95599 | uvex 2 xenova® | S1 SRC | 38 to 52 | Sandal, width 12 | 95349 | | | | | | | | | | | | 319 |
| 95607 | uvex 2 xenova® | S1 SRC | 38 to 52 | Perforated Shoe, width 10 | 95347 | | | | | | | | | | | | 321 |
| 95608 | uvex 2 xenova® | S1 SRC | 38 to 52 | Perforated Shoe, width 11 | 95348 | | | | | | | | | | | | 321 |
| 95609 | uvex 2 xenova® | S1 SRC | 38 to 52 | Perforated Shoe, width 12 | 95349 | | | | | | | | | | | | 321 |
| 95641 | uvex 2 xenova® | S3 SRC | 38 to 52 | Shoe, width 10 | 95347 | | | | | | | | | | | | 326 |
| 95642 | uvex 2 xenova® | S3 SRC | 38 to 52 | Shoe, width 11 | 95348 | | | | | | | | | | | | 326 |
| 95643 | uvex 2 xenova® | S3 SRC | 38 to 52 | Shoe, width 12 | 95349 | | | | | | | | | | | | 326 |
| 95647 | uvex 2 xenova® | S2 SRC | 38 to 52 | Shoe, width 10 | 95347 | | | | | | | | | | | | 324 |
| 95648 | uvex 2 xenova® | S2 SRC | 38 to 52 | Shoe, width 11 | 95348 | | | | | | | | | | | | 324 |
| 95649 | uvex 2 xenova® | S2 SRC | 38 to 52 | Shoe, width 12 | 95349 | | | | | | | | | | | | 324 |
| 95661 | uvex 2 xenova® | S3 SRC | 38 to 52 | Lace-up boot, width 10 | 95347 | | | | | | | | | | | | 327 |
| 95662 | uvex 2 xenova® | S3 SRC | 38 to 52 | Lace-up boot, width 11 | 95348 | | | | | | | | | | | | 327 |
| 95663 | uvex 2 xenova® | S3 SRC | 38 to 52 | Lace-up boot, width 12 | 95349 | | | | | | | | | | | | 327 |
| 95667 | uvex 2 xenova® | S2 SRC | 38 to 52 | Lace-up boot, width 10 | 95347 | | | | | | | | | | | | 325 |
| 95668 | uvex 2 xenova® | S2 SRC | 38 to 52 | Lace-up boot, width 11 | 95348 | | | | | | | | | | | | 325 |
| 95669 | uvex 2 xenova® | S2 SRC | 38 to 52 | Lace-up boot, width 12 | 95349 | | | | | | | | | | | | 325 |
| 95687 | uvex 2 xenova® | S2 SRC | 38 to 52 | Shoe, width 10 | 95347 | | | | | | | | | | | | 323 |
| 95688 | uvex 2 xenova® | S2 SRC | 38 to 52 | Shoe, width 11 | 95348 | | | | | | | | | | | | 323 |
| 95689 | uvex 2 xenova® | S2 SRC | 38 to 52 | Shoe, width 12 | 95349 | | | | | | | | | | | | 323 |
| 95790 | Inlay soles | | 38 to 52 | Comfortable climatic insole, width 14 | - | | | | | | | | | | | | 345 |
| 95797 | Inlay soles | | 35 to 52 | Comfortable climatic insole, width 10 | - | | | | | | | | | | | | 345 |
| 95798 | Inlay soles | | 36 to 52 | Comfortable climatic insole, width 11 | - | | | | | | | | | | | | 345 |
| 95799 | Inlay soles | | 37 to 52 | Comfortable climatic insole, width 12 | - | | | | | | | | | | | | 345 |
| 95950 | Inlay soles | | 36 to 48 | Comfortable climatic insole uvex hydroflex® GEL | - | | | | | | | | | | | | 347 |
| 95954 | Inlay soles | | 38 to 50 | Comfortable climatic insole uvex 3D hydroflex® foam | - | | | | | | | | | | | | 347 |
| 95956 | Inlay soles | | 35 to 50 | Comfortable climatic insole uvex 3D hydroflex® foam | - | | | | | | | | | | | | 347 |
| 9698100 | uvex nano shoe add on | | | Shoe impregnation | - | | | | | | | | | | | | 348 |
| 9698300 | uvex nano shoe add in | | | Shoe disinfectant | - | | | | | | | | | | | | 348 |
| 98754 | Accessories | | 39 to 48 | Tricot liner socks | - | | | | | | | | | | | | 349 |



Safety categories in accordance with EN ISO 20345

- SB Specification for safety shoes for industrial use with a toecap of 200 joules resistance
- S1 Areas in which the effects of moisture are not expected to be a factor. Antistatic properties, energy absorption in the heel, the closed heel region and resistance to fuel and oil also required.
- S2 Areas in which the effects of damp can also be expected. In addition to S1, also water-repellent (water-resistant) leather.
- S3 Areas for S2 shoes in which penetration resistance and a treaded sole are also required.
- S5 Wet areas in which penetration resistance and a treaded sole are also required.

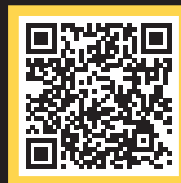

You can find more information at uvex-academy.com

This practical seminar will help you to analyse the dangers that employees face, determine what equipment is required to keep them safe and select the most appropriate protective footwear

- Basic information on the areas of application of PPE footwear
- Information on standards, the differences between primary and secondary requirements and their applications
- Description of the labels found on protective footwear and the meaning of the various codes
- Identification and assessment of dangers, developing a risk analysis strategy and understanding which safety equipment is necessary
- Information on materials, production processes and areas of application including:
 - Upper materials and lining
 - Soles
 - Protective toecaps
 - Penetration-resistant inlay
- Choosing the correct protective footwear for each application

Target group

Those responsible for the work-related health and safety of employees, e.g. health and safety officers, specialist purchasers and representatives of employee groups.



For more information or to book a place, please visit uvex-academy.de, call +49 (0)911 9736 1710 or email academy@uvex.de



Individual PPE



SBU Occupational Health

Individual personal protective equipment (PPE)

Individual personal protective equipment (PPE) from uvex. More than just a standard solution.

The health of employees is of great importance for any company. uvex offers premium tailor-made solutions for protecting eyes, ears and feet, offering maximum safety for the whole team.

Decades of experience and innovative technologies form the basis for products that are manufactured in our facilities in Germany in accordance with the most stringent safety standards. Our individual personal protective equipment ensures that maximum levels of safety and comfort are provided.

At uvex, innovation is not just a word: it is an intrinsic part of the corporate strategy. Many external awards confirm our continued commitment to this strategy for the future.

The investment in award winning designs, state-of-the-art materials and technologies allows uvex to deliver scientifically based product solutions which not only protect and are comfortable but have features which increase fit and therefore, wearer acceptance.

uvex – an exceptional partner.



- Certificates**
- ISO 9001
 - Ohris
 - REACH

Awards

Individual PPE from uvex – employee health is worth it.

- Individual eye, ear and foot protection
- Innovative technologies and solutions
- First-class, certified product quality
- Development and manufacturing in Germany
- Adjustments carried out by qualified specialists

Optics



Individual eye protection from uvex

Prescription safety spectacles protect the eyes, and improve the wearer's vision. uvex offers individual prescription safety and VDU (visual display unit) spectacles for all areas of application.

- Prescription safety spectacles certified in accordance with EN 166
- A wide selection of focus types and lens materials to meet all requirements
- An extremely wide range of frames, cater for all employee facial shapes
- Qualified advice and individual adjustment from opticians

Otoplastics



Individual hearing protection from uvex

Excessive noise in the workplace can lead to irreversible damage to hearing. Individually adapted uvex otoplastics fit perfectly, ensuring maximum wearer protection and comfort.

- Tailor-made hearing protection certified in accordance with EN 352
- A wide selection of filters, otoplastic shapes and materials ensures appropriate hearing protection is available for (virtually) all areas of application.
- Individual adjustments carried out by qualified specialists

Orthopaedics



Individual foot protection from uvex

Whether walking or standing still, safety footwear has to fit comfortably. uvex's orthopaedic foot protection is adapted to individual wearers' foot related medical conditions.

- Orthopaedic safety footwear certified in accordance with EN ISO 20345:2011
- For example, comfortable customised inserts and orthopaedic shoe adjustments
- A wide selection of suitable safety footwear
- Special footwear for extra wide feet and medical conditions (e.g. diabetes)
- Individual adjustments carried out by qualified orthopaedic specialists



SBU Occupational Health

uvex – a competent partner

uvex prides itself on its expertise and service delivery to the same high level as its products.

uvex offers an all-round professional service undertaking skilled risk assessments, through to the manufacture of individual safety products. The organisation is able to adapt its offer to meet the specific requirements of all companies.

Technological expertise



Innovation „Made in Germany“

Whether it's eye, ear or foot protection, the individual PPE range from uvex provides exceptional quality and the latest technology. uvex innovations continue to set new standards in industrial health and safety.

- uvex's prescription safety eyewear is recognised for its exceptional wearer comfort, stylistic designs and sophisticated functionality.
- uvex hearing protection is individually moulded to the shape of the ear canal ensuring optimum protection and comfort.
- uvex's customised safety footwear provides a solution for those with medical problems such as fallen arches, splay foot and flat feet.

Advisory expertise



Well-rounded professional expertise

Individual PPE products demand competent advisory expertise to guarantee the right solution and fit. For this reason, adjustments are carried out by qualified professionals such as opticians, acousticians and orthopaedic shoemakers.

Upon request, uvex can provide seminars for professional individuals (e.g. company doctors or occupational nurses) within companies to provide them with a level of knowledge about the adjustment of PPE products.

- Individual PPE products for all employees
- Certified products create legal certainty
- Adjustments carried out by qualified specialists
- uvex academy: seminars/safety days

Our extensive network of highly qualified experts in optics, acoustics and orthopaedics ensures the availability of first-rate quality of care in your area.

Service expertise



Tailored to meet requirements

Our products are not the only part of our service that we can tailor make. To ensure the maximum efficiency of your organisation, we can arrange for our professionals to visit your organisation – early mornings, evenings or at night if required.

- On site product customisation on request
- Service network of specialists throughout Germany
- Highly qualified in-house specialists
- Professional flexible solutions that are specifically tailored to the individual needs of your company

Social responsibility

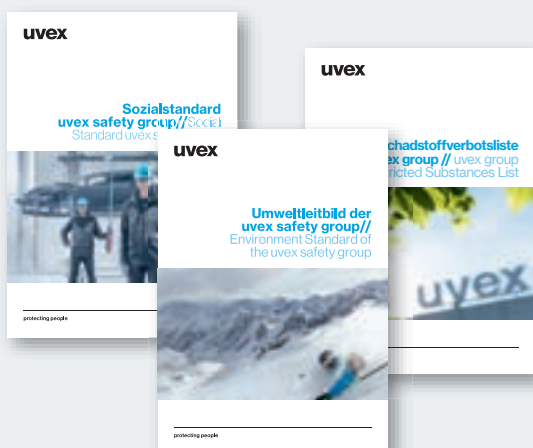

Sustainability guaranteed

uvex takes its social responsibility commitments seriously putting its environmental protection and social commitment at the forefront of its daily business.

- Sustainable manufacturing concept
- Avoidance of chemicals beyond the requirements of the EU REACH regulation (uvex's own banned hazardous substances list which goes beyond that of REACH)
- uvex social standard for all manufacturing plants
- Social commitment (e.g. Rainer Winter Foundation, Vision for the World)



uvex RX App

The virtual companion for prescription safety spectacles

Optimal selection of products – conveniently on the iPad.

What are the advantages of the different lens types and coatings for innovative uvex prescription safety spectacles? Find the optimum product to meet requirements quickly and easily using the practical uvex RX app.

For example, test at the touch of a button the effect different filters have on the optical properties of spectacles. The app includes striking videos which show the impact tests conducted to determine the stability of lenses. Comprehensive product brochures can also be downloaded for detailed information.

Range of information

Which prescription safety spectacles are best for your requirements? The uvex RX app offers comprehensive information, from innovative product specifications to impact test videos.

Realistic perspective

The uvex RX app provides a realistic experience of vision through varifocal lenses.



www.uvex-safety.com/uvex_app/uvex-rx



View everything

The uvex RX app makes product selection easier.

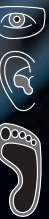

Prescription Safety Eyewear

Prescription safety spectacles

Basic collection plastic frames



5503 7415 54/17

5503 1300 50/17
5503 1300 54/17

uvex RX 5503

- plastic frames with classic lens shape
- transparent side shields with integrated brow guard
- good fit with anatomically shaped nose bridge

| uvex RX 5503 | | | |
|----------------------|-----------------|-----------------|-------------------------------|
| Art. no. | 6109219 | 6109203 | 6109204 |
| Ref. no. | 5503 1300 50/17 | 5503 1300 54/17 | 5503 7415 54/17 |
| Lens diameter | 50 mm | 54 mm | 54 mm |
| Bridge width | 17 mm | 17 mm | 17 mm |
| Colour | anthracite | anthracite | green, grey |
| Extras | | | metal arms with sprung hinges |



5504 1525 55/20

5504 1300 55/20

uvex RX 5504

- plastic frames with oval-shaped lenses
- transparent side shields with integrated brow guard
- good fit with anatomically shaped nose bridge

| uvex RX 5504 | | |
|----------------------|-----------------|-------------------------------|
| Art. no. | 6109206 | 6109207 |
| Ref. no. | 5504 1300 55/20 | 5504 1525 55/20 |
| Lens diameter | 55 mm | 55 mm |
| Bridge width | 20 mm | 20 mm |
| Colour | anthracite | grey, translucent |
| Extras | | metal arms with sprung hinges |



5511 3000 49/20



5511 1500 49/20

uvex RX 5511

- Kevlar round frame with metal arms
- transparent side shields
- good fit with anatomically shaped nose bridge and easily adjustable earpieces

| uvex RX 5511 | | |
|----------------------|-----------------|-----------------|
| Art. no. | 6108216 | 6108217 |
| Ref. no. | 5511 3000 49/20 | 5511 1500 49/20 |
| Lens diameter | 49 mm | 49 mm |
| Bridge width | 20 mm | 20 mm |
| Colour | blue | grey |
| Extras | metal arms | metal arms |

previously: uvex 9137 ceramic

Prescription safety spectacles

Basic collection plastic frames



5502 1725 56/15

5502 3525 56/15

uvex RX 5502

- close-fitting plastic frames
- side shields and integrated brow guard frame design
- specially shaped frames provide protection against particles from below
- good fit with anatomically shaped nose bridge
- individually adjustable side arms with four different lengths and adjustable soft-form comfort ear pieces

| uvex RX 5502 | | |
|----------------------|-----------------|-----------------|
| Art. no. | 6108215 | 6108202 |
| Ref. no. | 5502 1725 56/15 | 5502 3525 56/15 |
| Lens diameter | 56 mm | 56 mm |
| Bridge width | 15 mm | 15 mm |
| Colour | grey | light blue |



5506 1725 56/18

uvex RX 5506

- comfortable plastic frame
- side shields and integrated brow guard frame design
- good fit with anatomically shaped nose bridge

| uvex RX 5506 | |
|----------------------|-------------------------|
| Art. no. | 6109210 |
| Ref. no. | 5506 1725 56/18 |
| Lens diameter | 56 mm |
| Bridge width | 18 mm |
| Colour | light grey, translucent |

previously: uvex 9134 meteor



Prescription safety spectacles

Basic collection metal frames



5105 1800 50/20



5106 1400 50/20
5106 1400 52/20

uvex RX 5105

- metal frame with flat profile
- transparent side shields
- anatomically adjustable nose bridge and easily adjustable earpieces deliver exceptional fit

| | | |
|---------------|-----------------|--|
| uvex RX 5105 | | |
| Art. no. | 6109107 | |
| Ref. no. | 5105 1800 50/20 | |
| Lens diameter | 50 mm | |
| Bridge width | 20 mm | |
| Colour | silver | |

previously: uvex 9253 silverstar

uvex RX 5106

- classic design metal frame
- transparent side shields
- anatomically adjustable nose bridge and easily adjustable earpieces delivers exceptional fit

| | | |
|---------------|-----------------|-----------------|
| uvex RX 5106 | | |
| Art. no. | 6109108 | 6109109 |
| Ref. no. | 5106 1400 50/20 | 5106 1400 52/20 |
| Lens diameter | 50 mm | 52 mm |
| Bridge width | 20 mm | 20 mm |
| Colour | gunmetal, matt | gunmetal, matt |

previously: uvex 9254 greystar



5107 6200 47/20
5107 6200 49/20



5108 3400 54/19
5108 3400 56/19

uvex RX 5107

- metal frame with oval-shaped lenses
- transparent side shield
- anatomically adjustable nose bridge and easily adjustable earpieces delivers exceptional fit

| | | |
|---------------|-----------------|-----------------|
| uvex RX 5107 | | |
| Art. no. | 6109110 | 6109111 |
| Ref. no. | 5107 6200 47/20 | 5107 6200 49/20 |
| Lens diameter | 47 mm | 49 mm |
| Bridge width | 20 mm | 20 mm |
| Colour | antique gold | antique gold |

previously: uvex 9154 starlet

uvex RX 5108

- slim, expressive metal frame
- transparent side shields
- very good fit with anatomically adjustable nose bridge and easily adjustable earpieces

| | | |
|---------------|-----------------|-----------------|
| uvex RX 5108 | | |
| Art. no. | 6109112 | 6109113 |
| Ref. no. | 5108 3400 54/19 | 5108 3400 56/19 |
| Lens diameter | 54 mm | 56 mm |
| Bridge width | 19 mm | 19 mm |
| Colour | steel blue | steel blue |

previously: uvex 9155 mercury

Prescription safety spectacles

Basic collection metal frames



5102 1400 51/20
5102 1400 53/20



5103 1400 53/17
5103 1400 55/17

uvex RX 5102

- fashionable, aviator-style metal frame
- transparent side shields
- anatomically adjustable nose bridge and easily adjustable earpieces deliver exceptional fit

| uvex RX 5102 | | |
|---------------|-----------------|-----------------|
| Art. no. | 6109100 | 6109101 |
| Ref. no. | 5102 1400 51/20 | 5102 1400 53/20 |
| Lens diameter | 51 mm | 53 mm |
| Bridge width | 20 mm | 20 mm |
| Colour | gunmetal, matt | gunmetal, matt |

previously: uvex 9256 pilot

uvex RX 5103

- classic design metal frame with double bridge
- transparent side shields
- anatomically adjustable, soft nose pads and easily adjustable earpieces deliver exceptional fit

| uvex RX 5103 | | |
|---------------|-----------------|-----------------|
| Art. no. | 6109104 | 6109105 |
| Ref. no. | 5103 1400 53/17 | 5103 1400 55/17 |
| Lens diameter | 53 mm | 55 mm |
| Bridge width | 17 mm | 17 mm |
| Colour | gunmetal, matt | gunmetal, matt |



5101 1018 54/17
5101 1018 56/17



5104 6054 56/21

uvex RX 5101

- classic design metal frame with double bridge
- side shields made of wire mesh for good air circulation
- anatomically adjustable, soft nose pads and easily adjustable earpieces deliver exceptional fit
- arms with sprung hinges and easily adjustable earpieces

| uvex RX 5101 | | |
|---------------|-----------------|-----------------|
| Art. no. | 6109102 | 6109103 |
| Ref. no. | 5101 1018 54/17 | 5101 1018 56/17 |
| Lens diameter | 54 mm | 56 mm |
| Bridge width | 17 mm | 17 mm |
| Colour | black, silver | black, silver |

uvex RX 5104

- large metal frame design with double bridge
- transparent side shields
- anatomically adjustable, soft nose pads and easily adjustable earpieces deliver exceptional fit

| uvex RX 5104 | | |
|---------------|-----------------|--|
| Art. no. | 6109106 | |
| Ref. no. | 5104 6054 56/21 | |
| Lens diameter | 56 mm | |
| Bridge width | 21 mm | |
| Colour | gold, havanna | |



uvex RX ti Titanium frames

Titanium is a high-quality material used exclusively in the aerospace industry and medical technology. Titanium has been used in prescription frames since 1983.

Titanium is corrosion-resistant and does not provoke allergic reactions. With a specific density of 4.5 g/cm^3 , titanium is approximately half the weight of stainless steel.

- ▶ Extremely stable
- ▶ Low weight
- ▶ Allergy neutral
- ▶ Suitable for cold forming
- ▶ Provides excellent wearer comfort



Prescription safety spectacles

uvex RX ti



5900 1600 49/20

uvex RX ti 5900

- titanium frame with oval-shaped lenses
- transparent side shields
- frame is lightweight, allergy neutral and corrosion-resistant
- anatomically adjustable, soft nose pads and easily adjustable earpieces for exceptional fit

| | |
|----------------------|-----------------|
| uvex RX ti 5900 | |
| Art. no. | 6109400 |
| Ref. no. | 5900 1600 49/20 |
| Lens diameter | 49 mm |
| Bridge width | 20 mm |
| Colour | titanium blue |



5901 1600 50/20

uvex RX ti 5901

- classic design titanium frame
- transparent side shields
- frame is lightweight, allergy neutral and corrosion-resistant
- anatomically adjustable, soft nose pads and easily adjustable earpieces for exceptional fit

| | |
|----------------------|-----------------|
| uvex RX ti 5901 | |
| Art. no. | 6109401 |
| Ref. no. | 5901 1600 50/20 |
| Lens diameter | 50 mm |
| Bridge width | 20 mm |
| Colour | titanium blue |



5902 1600 52/19

uvex RX ti 5902

- thin lightweight titanium frame
- transparent side shields
- light, hypoallergenic pure titanium nose bridge and flexible arms made of beta-titanium
- anatomically adjustable, soft nose pads and easily adjustable earpieces for exceptional fit

| | |
|----------------------|-----------------|
| uvex RX ti 5902 | |
| Art. no. | 6109402 |
| Ref. no. | 5902 1600 52/19 |
| Lens diameter | 52 mm |
| Bridge width | 19 mm |
| Colour | titanium blue |

previously: uvex RX ti 9248



Prescription safety spectacles

uvex RX cb



Thanks to the special shape and overall width of the uvex RX cb frames, they are ideal for individuals with a flat nose bridge, high cheekbones and/or wide temples. The soft-form comfort ear pieces adjust to the wearer to ensure a non-slip fit.

uvex RX cb frames fulfil the requirements regarding field of vision (7.1.1) and side protection (7.2.8) in accordance with EN 166:2002 based on Asian headform 2M, as defined in DIS ISO 18526-4:2018.

Prescription safety spectacles

uvex RX cb



6109232

uvex RX cb 5580

- wide fitting plastic frame for the best fit
- frame design with side shields and integrated brow guard
- easily adjustable, soft-form ear pieces for extra comfort
- ideal for individuals with a flat nose bridge, high cheekbones and/or wide temples.
- tested for use with Asian headform 2M, DIS ISO 18526-4:2018

| | |
|-----------------|-----------------|
| uvex RX cb 5580 | |
| Art. no. | 6109232 |
| Ref. no. | 5580 3015 57/14 |
| Lens | 57 mm |
| Bridge width | 14 mm |
| Colour | dark blue, grey |



6109233

uvex RX cb 5581

- plastic frame with extra wide temple width
- frame design with side shields and integrated brow guard
- easily adjustable, soft-form ear pieces for extra comfort
- ideal for individuals with a flat nose bridge, high cheekbones and/or wide temples.
- tested for use with Asian headform 2M, DIS ISO 18526-4:2018

| | |
|-----------------|-----------------|
| uvex RX cb 5581 | |
| Art. no. | 6109233 |
| Ref. no. | 5581 1542 58/14 |
| Lens | 58 mm |
| Bridge width | 14 mm |
| Colour | grey, dark red |



Prescription safety spectacles

Lens options for plastic and metal frames in uvex basic collection models · uvex RX ti · uvex RX cb

| Focus type | | Lens type | Parameter for centering of the lenses |
|---|---|---|---|
| Description | | | Specific height Box measure |
| Single vision | | | |
| <ul style="list-style-type: none"> - Correction of visual defect in far, in-between or near distance |  | Single vision, Single vision HD | Single vision HD ≥ centre of lens Main line of sight |
| Certified prescription range | | | |
| Comfort lenses | | | |
| Nahcomfort - Version with expanded near vision - Ideal for workplace environments of 30 cm to approx. 2 m |  | Nahcomfort Standard, Nahcomfort Optima Versions see page 388 | min. 17 mm Main line of sight |
| Distanzcomfort - Calculation of the individual correction for defined distances (1 m, 2 m or 4 m) |  | Distanzcomfort Optima | min. 17 mm Zero line of sight |
| Single vision Relax - To accommodate the prescription for the lower part of the lens, the prescription is increased by +0.5 of a diopter |  | Single vision Relax | min. 17 mm Zero line of sight |
| Certified prescription range | | | |
| Bifocals | | | |
| <ul style="list-style-type: none"> - Correction of visual defect in far and reading distance - Visible segment for near distance - Steplike change from far distance to near distance at the edge of segment - Instantly well-tolerated, visible edge of segment supports orientation |  | Width of segment: 28 mm, curved | |
| Certified prescription range | | | |
| Varifocals | | | |
| <ul style="list-style-type: none"> - Correction of visual defect in far, in-between and near distance - Gliding change from far distance to near distance (progressive canal) - The non-visible gliding zone corrects in-between distances |  | Varifocal Standard - Standard area for far distance and near distance - Long, narrow canal of progression | min. 23 mm Zero line of sight |
| |  | Varifocal Pro Work - Large area for far distance - Wide canal of progression - Optimized area for reading distance | min. 20 mm Zero line of sight |
| |  | Varifocal Piccolo - Suitable for flat frames - Large area for far distance and near distance - Shortened canal of progression | min. 17 mm Zero line of sight |
| |  | Varifocal Top One - Very comfortable, large long-distance and close-up field of vision - Wide canal of progression for added convenience - Minimal blur in peripheral vision | min. 19 mm Zero line of sight |
| |  | Varifocal Optima, Varifocal Optima HD - Individual adjusted multifocal lens of latest generation - Wide field of view for any distance - Improved design - Almost no blurred zones in periphery area >> Version HD see page 388 | Optima min. 17 mm Optima HD min. 16 mm (depending on the corridor length) Zero line of sight |
| Certified prescription range | | | |

- ▶ The overview shows the maximum prescription range which is approved and certified. Depending on the size of the frame and the lens material, further restrictions may apply.
- ▶ Please take into account the specifications relating to the line of sight when determining the vision point.

| Material | | | | | | | Extras, optional | | | | | |
|---|---|--|--|---|--|-----------------------|---|-------------|--------------------------|------|---|--|
| CR 39 | HI 1.6 | Plastic HI 1.67 | PC | Trivex | Silicate Hard glass | Normal AR | Multi AR | Super AR | UV blue protect | Tint | Variomatic brown | |
| ■ | ■ | ■ | ■ | ■ | HD not available | ■ | ■ | ■ | ■ | ■ | ■ | |
| | incl. hard coating recommended from +/- 4.0 dpt. | incl. hard coating only available with SAR recommended from +/- 6.0 dpt. | incl. hard coating | incl. hard coating only available with SAR | | only single vision | only single vision, not for hard glass | ■ | only HI 1.67 or PC | | only Polycarbonate or Trivex | |
| +10.0 to -10.0 dpt. at maximum value cyl. ±8.0 dpt. | +12.0 to -13.0 dpt. at maximum value cyl. ±8.0 dpt. | +13.0 to -14.5 dpt. at maximum value cyl. ±8.0 dpt. | +9.5 to -12.0 dpt. at maximum value cyl. ±8.0 dpt. | +8.0 to -11.0 dpt. at maximum value cyl. ±7.0 dpt. | +7.0 to -6.0 dpt. at maximum value cyl. ±4.0 dpt. | | | | | | +7.5 to -8.5 dpt. at maximum value cyl. ±6.0 dpt. | |
| Standard/ Optima | only Optima | only Optima | Standard/ Optima | only Optima | — | ■ | not for hard glass | ■ | only HI 1.67 or PC | — | — | |
| ■ | ■ | ■ | ■ | ■ | — | ■ | not for hard glass | ■ | only HI 1.67 or PC | — | — | |
| ■ | ■ | ■ | ■ | ■ | — | ■ | not for hard glass | ■ | only HI 1.67 or PC | — | — | |
| +9.0 to -7.5 dpt. at maximum value cyl. ±6.0 dpt. | +8.0 to -8.0 dpt. at maximum value cyl. ±6.0 dpt. | +9.0 to -10.0 dpt. at maximum value cyl. ±6.0 dpt. | +9.0 to -4.5 dpt. at maximum value cyl. ±6.0 dpt. | +7.0 to -6.0 dpt. at maximum value cyl. ±4.0 dpt. | +6.0 to -4.5 dpt. at maximum value cyl. ±4.0 dpt. | | | | | | | |
| ■ | ■ | — | ■ | — | ■ | ■ | not for hard glass | ■ | — | ■ | — | |
| +7.0 to -8.0 dpt. at maximum value cyl. ±6.0 dpt. Add. +3.0 | +8.5 to -10.5 dpt. at maximum value cyl. ±8.0 dpt. Add. +3.0 | | +10.0 to -10.0 dpt. at maximum value cyl. ±6.0 dpt. Add. +3.0 | | +6.0 to -6.0 dpt. at maximum value cyl. ±4.0 dpt. Add. +3.0 | | | | | | | |
| ■ | ■ | ■ | ■ | — | ■ | ■ | not for hard glass | ■ | — | ■ | only Polycarbonate | |
| ■ | ■ | ■ | ■ | ■ | ■ | ■ | not for hard glass | ■ | only HI 1.67 or PC | ■ | only Polycarbonate or Trivex | |
| ■ | ■ | ■ | ■ | — | ■ | ■ | — | ■ | — | ■ | only Polycarbonate | |
| ■ | ■ | ■ | ■ | — | ■ | ■ | not for hard glass | ■ | only HI 1.67 or PC | ■ | only Polycarbonate | |
| ■ | ■ | ■ | ■ | ■ | — | only Optima | only Optima not for hard glass | ■ | only HI 1.67 or PC | ■ | only Polycarbonate or Trivex | |
| +6.0 to -10.0 dpt. at maximum value cyl. ±6.0 dpt. Add. +3.0 | +9.5 to -12.0 dpt. at maximum value cyl. ±6.0 dpt. Add. +3.0 | +10.0 to -12.0 dpt. at maximum value cyl. ±6.0 dpt. Add. +3.0 | +9.5 to -10.0 dpt. at maximum value cyl. ±6.0 dpt. Add. +3.0 | +6.0 to -13.0 dpt. at maximum value cyl. ±6.0 dpt. Add. +3.0 | +6.0 to -6.0 dpt. at maximum value cyl. ±4.0 dpt. Add. +3.0 | | | | | | +7.5 to -10.0 dpt. at maximum value cyl. ±6.0 dpt. Add. +3.0 | |



Prescription safety spectacles

uvex RX cd



5518 1333 54/22



5518 1341 54/22



5518 5074 54/22

uvex RX cd 5518

- sporty frame design: attractive and durable
- metal-free
- comfortable soft arms (uvex duo component technology), non-slip fit without pressure points
- good fit thanks to anatomically shaped nose bridge

| uvex RX cd 5518 | | | |
|-----------------|-----------------|-------------------|------------------|
| Art. no. | 6109230* | 6109231* | 6109234* |
| Ref. no. | 5518 1341 54/22 | 5518 5074 54/22 | 5518 1333 54/22 |
| Lens diameter | 54 mm | 54 mm | 54 mm |
| Bridge width | 22 mm | 22 mm | 22 mm |
| Colour | anthracite, red | dark brown, green | anthracite, blue |

► Please note the glazing options for uvex RX cd on page 380/381



* These frames fulfil the requirements regarding field of vision (7.1.1) and side protection (7.2.8) in accordance with EN 166:2002 based on Asian headform 2M, as defined in DIS ISO 18526-4:2018.

Prescription safety spectacles

uvex RX cd



5520 1333 54/18



5520 1344 54/18

uvex RX cd 5520

- contemporary plastic frame in stylish colours
- good fit thanks to anatomically shaped nose bridge
- translucent lens frame for an unobstructed field of view
- uvex Comfort Sliders allow the side arm length and inclination to be adjusted for a customised fit
- the spectacles can also be worn without uvex Comfort Sliders
- completely metal-free

| uvex RX cd 5520 | | |
|-----------------|------------------|------------------|
| Art. no. | 6109236* | 6109245* |
| Ref. no. | 5520 1333 54/18 | 5520 1344 54/18 |
| Lens diameter | 54 mm | 54 mm |
| Bridge width | 18 mm | 18 mm |
| Colour | anthracite, blue | anthracite, pink |

► Please note the glazing options for uvex RX cd on pages 380/381



Accessories for uvex x-fit pro non-prescription safety spectacles are compatible with uvex RX cd 5520 and can be purchased from the uvex online shop.

<https://www.uvex-safety-shop.de/home>

uvex Comfort Slider
Art. no. 9958024
Order unit 1 PC
Contents 5 pairs

uvex mini LED light
Art. no. 9999100
Order unit 1 PC

uvex x-fit pro headband
Art. no. 9958023
Order quantity multiples 5 PC



Prescription safety spectacles

uvex RX cd



5514 1033 53/18



5514 1045 55/18

uvex RX cd 5514

- close-fitting plastic frame
- transparent side shields and integrated brow guard frame design
- soft, adjustable nose bridge
- easily adjustable soft-form comfort ear pieces

| uvex RX cd 5514 | | |
|----------------------|-----------------|-----------------|
| Art. no. | 6109225* | 6109226* |
| Ref. no. | 5514 1033 53/18 | 5514 1045 55/18 |
| Lens diameter | 53 mm | 55 mm |
| Bridge width | 18 mm | 18 mm |
| Colour | black, blue | black, red |

► Please note the glazing options for uvex RX cd on page 380/381



5515 1347 51/17



5515 1371 53/17



5515 1342 57/17

uvex RX cd 5515

- close-fitting plastic frame
- side shields and integrated brow guard frame design
- soft, adjustable nose bridge
- easily adjustable soft-form comfort ear pieces

| uvex RX cd 5515 | | | |
|----------------------|-------------------|--------------------|----------------------|
| Art. no. | 6109227 | 6109228* | 6109229* |
| Ref. no. | 5515 1347 51/17 | 5515 1371 53/17 | 5515 1342 57/17 |
| Lens diameter | 51 mm | 53 mm | 57 mm |
| Bridge width | 17 mm | 17 mm | 17 mm |
| Colour | anthracite, coral | anthracite, petrol | anthracite, dark red |

► Please note the glazing options for uvex RX cd on page 380/381

Prescription safety spectacles

uvex RX cd



5505 2900 55/19
5505 2900 57/19



5505 2126 55/19
5505 2126 57/19

uvex RX cd 5505

- close-fitting plastic frames
- integrated side shields and brow guard for an exceptionally close fit
- specially shaped frames provide protection against particles from below
- good fit with anatomically shaped nose bridge
- individually adjustable side arm length and angle for a customised fit and adjustable soft-form comfort ear pieces

uvex RX cd 5505

| | | | | |
|----------------------|-----------------|-----------------|-----------------|-----------------|
| Art. no. | 6109208 | 6109209 | 6109214 | 6109215 |
| Ref. no. | 5505 2900 55/19 | 5505 2900 57/19 | 5505 2126 55/19 | 5505 2126 57/19 |
| Lens diameter | 55 mm | 57 mm | 55 mm | 57 mm |
| Bridge width | 19 mm | 19 mm | 19 mm | 19 mm |
| Colour | transparent | transparent | crystal, matt | crystal, matt |

► Please note the glazing options for uvex RX cd on page 380/381



5505 9020 55/19
5505 9020 57/19

uvex RX cd 5505 plan PC SAR

- plastic frame with polycarbonate lenses for users who do not require a prescription
- non-prescription lenses with super anti-reflective coating – to minimise reflections on surfaces

uvex RX cd 5505 plan PC SAR

| | | |
|----------------------|---------------------------|---------------------------|
| Art. no. | 6108208 | 6108209 |
| Ref. no. | 5505 9020 55/19 | 5505 9020 57/19 |
| Lens diameter | 55 mm | 57 mm |
| Bridge width | 19 mm | 19 mm |
| Colour | crystal, matt | crystal, matt |
| Configuration | flat polycarbonate lenses | flat polycarbonate lenses |
| | HC, SAR | HC, SAR |
| Order unit | PC | PC |



5505 seal 55/19
5505 seal 57/19



5505 2126 55/19 with 5505 seal 55/19



5505 2900 57/19 with 5505 seal 57/19

uvex RX cd 5505 seal

- foam seal frame for uvex RX cd 5505 for use when working with dust, chips or fluids
- complies with EN 166 "Protection against liquid droplets and splashes" (category "3")

uvex RX cd 5505 seal

| | | |
|------------------------|------------------|------------------|
| Art. no. | 6118000 | 6118001 |
| Ref. no. | 5505 seal 55/19 | 5505 seal 57/19 |
| Lens diameter | 55 mm | 57 mm |
| Bridge width | 19 mm | 19 mm |
| Colour | black | black |
| Compatible with | Art. no. 6108208 | Art. no. 6108209 |
| | Art. no. 6109208 | Art. no. 6109209 |
| | Art. no. 6109214 | Art. no. 6109215 |
| Order unit | PC | PC |



Prescription safety spectacles

uvex RX cd 5505 flip-up – special versions



5505 9910 55/19
5505 9910 57/19

uvex RX cd 5505 flip-up, didymium

- flip-up incl. non-prescription didymium lenses
- didymium lenses are special filters with a high absorption rate of 589 nm
- they filter bright yellow sodium flare
- lightweight polycarbonate filter with high mechanical strength
- level of protection 2-2 in accordance with EN 170, mech. strength F in accordance with EN 166
- Note: Didymium lenses do not provide increased protection against infrared radiation (IR)

| uvex RX cd 5505 flip-up, didymium | | |
|-----------------------------------|---------------------|---------------------|
| Art. no. | 6109237 | 6109238 |
| Ref. no. | 5505 9910 55/19 | 5505 9910 57/19 |
| Lens diameter | 55 mm | 57 mm |
| Bridge width | 19 mm | 19 mm |
| Colour | crystal matt, green | crystal matt, green |
| Features: flip-up | | |
| Lenses | violet PC, didymium | violet PC, didymium |
| Lens marking | 2-2 W 1 F CE | 2-2 W 1 F CE |



5505 9975 55/19
5505 9975 57/19

uvex RX cd 5505 flip-up, X-ray protection

- flip-up incl. non-prescription mineral lenses that provide X-ray protection
- the lead equivalent of the protective lenses is 0.75
- protective X-ray lenses are not tested and marked in accordance with EN 166

| uvex RX cd 5505 flip-up, X-ray protection | | |
|---|----------------------|----------------------|
| Art. no. | 6109241 | 6109242 |
| Ref. no. | 5505 9975 55/19 | 5505 9975 57/19 |
| Lens diameter | 55 mm | 57 mm |
| Bridge width | 19 mm | 19 mm |
| Colour | crystal matt, green | crystal matt, green |
| Features: flip-up | | |
| Lenses | Leaded mineral glass | Leaded mineral glass |
| Lens marking | Pbeq 0.75 | Pbeq 0.75 |

Prescription safety spectacles

uvex RX cd 5505 flip-up – special versions



5505 9965 55/19
5505 9965 57/19

uvex RX cd 5505 flip-up, CBR65

- flip-up incl. non-prescription CBR65 lenses
- high-contrast, fatigue-free vision
- in workplaces with extremely harsh lighting conditions, blue light is reduced by up to 50%
- slight tint for LED lights, computers and other visual display screens that produce bright, harsh unnatural light with high blue content, or for those working outdoors

| uvex RX cd 5505 flip-up, CBR65 | | |
|--------------------------------|---------------------|---------------------|
| Art. no. | 6109243 | 6109244 |
| Ref. no. | 5505 9965 55/19 | 5505 9965 57/19 |
| Lens diameter | 55 mm | 57 mm |
| Bridge width | 19 mm | 19 mm |
| Colour | crystal matt, green | crystal matt, green |
| Features: flip-up | | |
| Lens | PC CBR65 | PC CBR65 |
| Lens marking | 5-1.4 W 1 FK CE | 5-1.4 W 1 FK CE |



5505 9911 55/19
5505 9911 57/19

uvex RX cd 5505 flip-up, polarising filter

- flip-up incl. non-prescription lenses with polarising filter
- polarising filters only let in radiation from one vibration direction – scattered radiation (e.g. reflection on the surface of water) is suppressed
- particularly suitable for workplaces with a high risk of glare (e.g. offshore, maritime environment, construction industry) and/or highly reflective surfaces
- level of protection 5-3.1 in accordance with EN 172, mech. strength F in accordance with EN 166

| uvex RX cd 5505 flip-up, polarising filter | | |
|--|---------------------|---------------------|
| Art. no. | 6109239 | 6109240 |
| Ref. no. | 5505 9911 55/19 | 5505 9911 57/19 |
| Lens diameter | 55 mm | 57 mm |
| Bridge width | 19 mm | 19 mm |
| Colour | crystal matt, green | crystal matt, green |
| Features: flip-up | | |
| Lens | grey PC, polarising | grey PC, polarising |
| Lens marking | 5-3.1 W 1 F CE | 5-3.1 W 1 F CE |



5505 9905 55/19
5505 9905 57/19

uvex RX cd 5505 flip-up welding protection

- flip-up with welding protection lenses, non-prescription
- level of protection 5 (welding), suitable for autogenous welding
- new filter technology with grey-tinted lenses provides reliable protection against UV and infrared radiation as well as ensuring perfect colour recognition
- Note: welding protection lenses do not provide sufficient protection against laser beams!
- level of protection 5 in accordance with EN 169 (welding), mech. strength F in accordance with EN 166

| uvex RX cd 5505 flip-up welding protection | | |
|--|---|---|
| Art. no. | 6109218 | 6109235 |
| Ref. no. | 5505 9905 55/19 | 5505 9905 57/19 |
| Lens | 55 mm | 57 mm |
| Bridge width | 19 mm | 19 mm |
| Colour | black, green | black, green |
| Features: flip-up | | |
| Lens | PC grey, welding protection 5 uvex infraradur plus | PC grey, welding protection 5 uvex infraradur plus |
| Lens marking | 5 W1 FTK CE | 5 W1 FTK CE |



Prescription safety spectacles

Lens options for uvex RX cd













uvex RX cd 5505



uvex RX cd 5505 flip-up



uvex RX cd 5514

| | | | | | Lens type | Parameter for centering of the lenses |
|--|---|--|--|--|--|---|
| Description | | | | | | Specific height Box measure |
| Single vision | | | | | | |
|  | | | | | Single vision, Single vision HD | Single vision HD min. centre of lens Main line of sight |
| Prescription range | | | | | | |
| Comfort lenses | | | | | | |
|  Nahcomfort Standard |  Nahcomfort Optima |  Distanzcomfort Optima |  Single vision Relax | | Nahcomfort Standard, Nahcomfort Optima Versions see page 388 | min. 17 mm Main line of sight |
| | | | | | Distanzcomfort Optima | min. 17 mm Zero line of sight |
| | | | | | Single vision Relax | min. 17 mm Zero line of sight |
| Prescription range | | | | | | |
| Bifocals | | | | | | |
|  | | | | | Width of segment: 28 mm, curved | |
| Prescription range | | | | | | |
| Varifocals | | | | | | |
|  Varifocal Standard |  Varifocal Pro Work |  Varifocal Piccolo |  Varifocal Top One |  Varifocal Optima Varifocal Optima HD | Varifocal Standard | min. 23 mm Zero line of sight |
| | | | | | Varifocal Pro Work | min. 20 mm Zero line of sight |
| | | | | | Varifocal Piccolo | min. 17 mm Zero line of sight |
| | | | | | Varifocal Top One | min. 19 mm Zero line of sight |
| | | | | | Varifocal Optima | min. 17 mm Zero line of sight |
| | | | | | Varifocal Optima HD | min. 16 mm (depending on the corridor length) Zero line of sight |
| Prescription range | | | | | | |

► In order to ensure optimum vision, uvex compensate the values in accordance to the frame wrap angle (FWA).
The overview below provides information on the lens options for uvex RX cd frames.
Please also ensure the frame fits correctly.

► Please take into account the specifications relating to the line of sight when determining the vision point.



uvex RX cd 5515



uvex RX cd 5518



uvex RX cd 5520

| | Material | | | | | Extras, optional | | | | | |
|--|---|---|---|---|---|--------------------|--------------------|----------|----------------------------|---------|---|
| | CR 39 | HI 1.6 | HI 1.67 | PC | Trivex | Normal AR | Multi AR | Super AR | UV blue protect | Tinting | Variomatic brown |
| | ■ | ■ | ■ | ■ | ■ | ■ | ■ | ■ | ■ | ■ | ■ |
| | | incl. hard coating | incl. hard coating only available with SAR | incl. hard coating | incl. hard coating only available with SAR | only single vision | only single vision | | only HI 1.67 or PC | | only Polycarbonate or Trivex |
| | +6.0 to -6.0 dpt. at maximum value cyl. ±4.0 dpt. | +6.0 to -6.0 dpt. at maximum value cyl. ±4.0 dpt. | +6.0 to -6.0 dpt. at maximum value cyl. ±4.0 dpt. | +6.0 to -6.0 dpt. at maximum value cyl. ±4.0 dpt. | +6.0 to -6.0 dpt. at maximum value cyl. ±4.0 dpt. | | | | | | +6.0 to -6.0 dpt. at maximum value cyl. ±4.0 dpt. |
| | Standard/Optima | only Optima | only Optima | Standard/Optima | only Optima | ■ | ■ | ■ | only Optima, HI 1.67 or PC | — | — |
| | ■ | ■ | ■ | ■ | ■ | ■ | ■ | ■ | only HI 1.67 or PC | — | — |
| | ■ | ■ | ■ | ■ | ■ | ■ | ■ | ■ | only HI 1.67 or PC | — | — |
| | +6.0 to -6.0 dpt. at maximum value cyl. ±4.0 dpt. | +6.0 to -6.0 dpt. at maximum value cyl. ±4.0 dpt. | +6.0 to -6.0 dpt. at maximum value cyl. ±4.0 dpt. | +6.0 to -6.0 dpt. at maximum value cyl. ±4.0 dpt. | +6.0 to -6.0 dpt. at maximum value cyl. ±4.0 dpt. | | | | | | |
| | ■ | ■ | — | ■ | — | ■ | ■ | ■ | — | ■ | — |
| | +6.0 to -6.0 dpt. at maximum value cyl. ±4.0 dpt. | +6.0 to -6.0 dpt. at maximum value cyl. ±4.0 dpt. | | +6.0 to -6.0 dpt. at maximum value cyl. ±4.0 dpt. | | | | | | | |
| | ■ | ■ | ■ | ■ | — | ■ | ■ | ■ | — | ■ | only Polycarbonate |
| | ■ | ■ | ■ | ■ | ■ | ■ | ■ | ■ | only, HI 1.67 or PC | ■ | only Polycarbonate or Trivex |
| | ■ | ■ | ■ | ■ | — | ■ | — | ■ | — | ■ | only Polycarbonate |
| | ■ | ■ | ■ | ■ | — | ■ | ■ | ■ | only, HI 1.67 or PC | ■ | only Polycarbonate |
| | ■ | ■ | ■ | ■ | ■ | ■ | ■ | ■ | only, HI 1.67 or PC | ■ | only Polycarbonate or Trivex |
| | ■ | ■ | ■ | ■ | ■ | only Optima | only Optima | ■ | only, HI 1.67 or PC | ■ | only Polycarbonate or Trivex |
| | +6.0 to -6.0 dpt. at maximum value cyl. ±4.0 dpt. | +6.0 to -6.0 dpt. at maximum value cyl. ±4.0 dpt. | +6.0 to -6.0 dpt. at maximum value cyl. ±4.0 dpt. | +6.0 to -6.0 dpt. at maximum value cyl. ±4.0 dpt. | +6.0 to -6.0 dpt. at maximum value cyl. ±4.0 dpt. | | | | | | +6.0 to -6.0 dpt. at maximum value cyl. ±4.0 dpt. |



uvex RX sp
Lifestyle at work

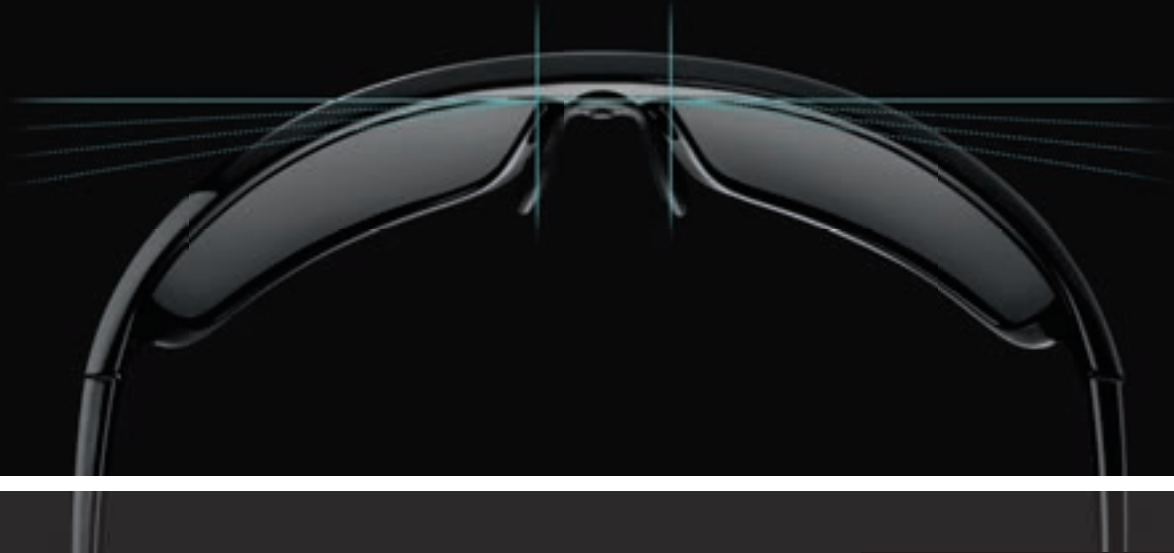

uvex RX sp frames

Make a statement with the uvex RX sp collection which stands out due to its sporty design and appealing frame colour combinations . All protection functions are fully integrated into the frame design requiring no separate side guards which is commonly the case with conventional protective spectacles.

The wraparound design offers the perfect fit and maximum protection thanks to its wide side arms and curvature of the lens. As with all uvex models, only the highest quality plastics are used in its protection.

uvex anatomic sport lens

The stronger curve of the uvex RX sp frame positions the lenses at an angle straight in front of the eye. We only use the specially developed uvex anatomic sport glazing to deliver maximum optical clarity.

This means:

- that we only use lenses with a base curve identical to that of the frame.
- that prescription values need to be recalculated based on the tilted position of the lenses. This will be considered for the glazing process.

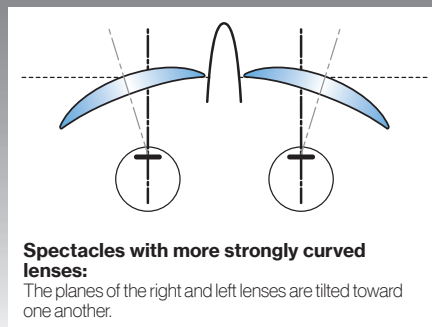
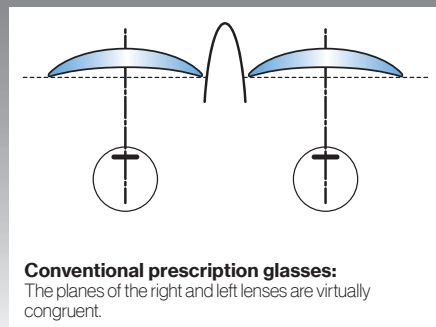

uvex HD lenses

uvex HD lenses – maximum individuality

A number of individual parameters are taken into account in the manufacture of uvex HD lenses:

- individual prescription values
- centering parameters (pupillary distance, fitting height)
- base curve of the lenses and the frame
- face form-wrap and pantoscopic tilt
- corneal vertex distance

Special programs have been developed to map thousands of individual points on the inside of the lenses. The results are directly incorporated into the customised uvex optima HD lenses.

No greater customisation is possible.

uvex HD lenses are available in the single vision HD and varifocal Optima HD designs. uvex service opticians or your uvex optical consultant will determine the individual measurements for you.

Prescription safety spectacles

uvex RX sp



5512 5573 65/16



5512 1348 65/16

uvex RX sp 5512

- sporty, plastic “wraparound” design with curved lenses and anatomic sport glazing
- uvex tight-fit-kit consisting of headband and foam material available
- side shield and integrated brow guard frame design
- the arms can be replaced with a headband for a more secure fit when working in extreme conditions
- the foam material guarantees a close and firm fit.
- very good fit with anatomically adjustable, soft nose bridge
- sporty side arms with a combination of soft and hard components ensure increased comfort and non-slip fit

Applications in combination with the tight-fit-kit:

- working in extreme situations, such as overhead or in confined spaces
- working with fluids (drops) or chips and dust

| uvex RX sp 5512 | | |
|-----------------|-----------------|--------------------|
| Art. no. | 6109220 | 6109221 |
| Ref. no. | 5512 5573 65/16 | 5512 1348 65/16 |
| Lens diameter | 65 mm | 65 mm |
| Bridge width | 16 mm | 16 mm |
| Colour | brown, olive | anthracite, orange |

| uvex tight-fit-kit | | |
|--------------------|--|--|
| Art. no. | 6118004 | 6118005 |
| Design | uvex tight-fit-kit for uvex RX sp 5512 | uvex tight-fit-kit for uvex RX sp 5512 |
| Colour | brown, olive | anthracite, orange |
| Order unit | PC | PC |

► Please note the glazing options for uvex RX sp on page 386/387



6118004



5512 5573 65/16 assembled with uvex tight-fit-kit 6118004



6118005



5512 1348 65/16 assembled with uvex tight-fit-kit 6118005



5513 1577 62/16

uvex RX sp 5513

- sporty, plastic “wraparound” design with large lenses and anatomic sport glazing
- side shield and integrated brow guard frame design
- good fit due to anatomically shaped soft nose bridge
- sporty arms with a combination of soft and hard components ensure increased comfort and non-slip fit

| uvex RX sp 5513 | |
|-----------------|-------------------|
| Art. no. | 6109222 |
| Ref. no. | 5513 1577 62/16 |
| Lens diameter | 62 mm |
| Bridge width | 16 mm |
| Colour | grey, light green |

► Please note the glazing options for uvex RX sp on pages 386/387



Prescription safety spectacles

uvex RX sp



5519 5573 56/21



5519 1371 56/21

uvex RX sp 5519

- plastic frame with sporty wrap-around design
- anatomically shaped, soft nose bridge
- side shields and integrated brow guard frame design
- specially-shaped frame edge provides protection against particles from below
- easily adjustable soft-form comfort ear pieces

| uvex RX sp 5519 | | |
|-----------------|-----------------|--------------------|
| Art. no. | 6109223 | 6109224 |
| Ref. no. | 5519 5573 56/21 | 5519 1371 56/21 |
| Lens diameter | 56 mm | 56 mm |
| Bridge width | 21 mm | 21 mm |
| Colour | brown, olive | anthracite, petrol |

► Please note the glazing options for uvex RX sp on pages 386/387



5510 1217 62/17



5510 1248 62/17

uvex RX sp 5510

- sporty, plastic “wraparound” design with curved lenses and anatomic sport glazing
- side shield and integrated brow guard frame design
- good fit with anatomically shaped soft nose bridge
- sporty arms with a combination of soft and hard components ensure increased comfort and non-slip fit

| uvex RX sp 5510 | | |
|-----------------|------------------------|--------------------|
| Art. no. | 6109216 | 6109217 |
| Ref. no. | 5510 1217 62/17 | 5510 1248 62/17 |
| Lens diameter | 62 mm | 62 mm |
| Bridge width | 17 mm | 17 mm |
| Colour | matt black, light grey | matt black, orange |

► Please note the glazing options for uvex RX sp on pages 386/387

uvex RX goggle

The first wide-vision goggles directly fitted with prescription lenses

Direct prescription lenses ensure perfect vision at all times.

uvex RX goggle: the first wide-vision goggles that can be directly fitted with prescription lenses. In contrast to standard prescription solutions with overspecs or prescription inserts, these goggles offer the best possible optical quality without optical aberrations and additional loss of light. The uvex RX goggle can therefore, be worn for extended periods with complete comfort.

Spectrophotometer measurements have shown that the transmission factor of the uvex RX goggle is up to 18% higher than safety goggles with prescription inserts or overspecs. The higher transmission level minimises the strain on eye muscles. This is further boosted by an additional anti-reflective coating on the prescription lenses.



Direct prescription lenses

Prescription safety lenses are inserted directly into the goggle frame according to the individual prescription strength.



Flexible headband clip

The flexible headband clip allows the goggle to adjust to different facial shapes for a customised fit. The comfortable fabric headband keeps the uvex RX goggle securely in place.



Sophisticated ventilation

Direct and indirect air vents ensure optimum protection and excellent ventilation for "eye zone" comfort.

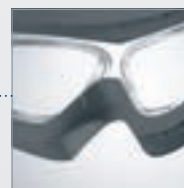

Hygiene

The flexible TPU frame is easy to clean. These goggles can be kept clean and hygienic, even under heavy strains and in extreme conditions.



uvex RX goggle

| | |
|----------------|------------------|
| uvex RX goggle | |
| Art. no. | 6109500 |
| Ref. no. | 9500 1379 61/14 |
| Lens | 61 mm |
| Bridge width | 14 mm |
| Colour | anthracite, lime |



Safety eyewear case with pocket for regular spectacles included

► Please note the glazing options for uvex RX goggle on pages 386/387

PC+

uvex uses highly impact resistant polycarbonate and has also increased the thickness in the middle of the lens. To ensure the eyewear remains securely in place upon impact, the frame is equipped with a special shock absorbing nut and the lenses have been shaped to deflect objects.

As a result, these prescription safety spectacles are the first to ever achieve mechanical strength class B. The frame and lenses both bear the relevant labelling.

For testing mechanical strength "B" a metal ball is fired frontal and lateral against the spectacle with impact speed of 432 km/h. (Comparison EN 166: impact with medium energy, 120 m/sec)

Recommended applications

for uvex RX goggles with PC+:

Workplaces with high risk of mechanical hazards, such as reshaping metal-cuttings, turning, grinding and milling.

► Mechanical strength "B", 120 m/s

for uvex RX goggles with Trivex:

Workplaces with high risk of chemical hazards, such as laboratories and those handling small quantities of chemicals.

► Mechanical strength "F", 45 m/s

For further information on lens materials and models, information can be found on page 388-390



Prescription safety spectacles

Lens options for uvex RX sp models · Special lenses for uvex RX goggle

| uvex RX sp 5519, uvex RX sp 5510 | | Important note | Lens type | Parameter for centering of the lenses | |
|---|----------------------------------|---|-----------------------|---------------------------------------|---------------------------------------|
| Description | | | | Specific height Box measure | |
|  | Single vision | for uvex RX sp 5510: Minimum PD ≥ 32.0 mm Fitting height ≥ centre of lens | Single vision | Main line of sight | |
| | | | Single vision HD | | |
| | Comfort lenses | for uvex RX sp 5510: Minimum PD ≥ 32.0 mm Fitting height ≥ centre of lens | Nahcomfort Optima | min. 17 mm Main line of sight | |
| | | | Distanzcomfort Optima | min. 17 mm Zero line of sight | |
| | | | Single vision Relax | min. 17 mm Zero line of sight | |
| | Varifocals | for uvex RX sp 5510: Minimum PD ≥ 32.0 mm Fitting height ≥ centre of lens | Varifocal Pro Work | min. 20 mm Zero line of sight | |
| | | | Varifocal Optima | min. 17 mm Zero line of sight | |
| | | | Varifocal Optima HD | min. 16 mm Zero line of sight | |
| | Prescription range | | | | |
| | uvex RX sp 5512, uvex RX sp 5513 | | Important note | Lens type | Parameter for centering of the lenses |
| Description | | | | Specific height Box measure | |
|  | Single vision | Minimum PD ≥ 32.0 mm Fitting height ≥ centre of lens | Single vision | Main line of sight | |
| | | | Single vision HD | | |
| | Comfort lenses | Minimum PD ≥ 32.0 mm Fitting height ≥ centre of lens | Nahcomfort Optima | min. 17 mm Main line of sight | |
| | | | Distanzcomfort Optima | min. 17 mm Zero line of sight | |
| | | | Single vision Relax | min. 17 mm Zero line of sight | |
| | Varifocals | Minimum PD ≥ 32.0 mm Fitting height ≥ centre of lens | Varifocal Pro Work | min. 20 mm Zero line of sight | |
| | | | Varifocal Optima | min. 17 mm Zero line of sight | |
| | | | Varifocal Optima HD | min. 16 mm Zero line of sight | |
| | Prescription range | | | | |
| | uvex RX goggle | | Important note | Lens type | Parameter for centering of the lenses |
| Description | | | | Specific height Box measure | |
|  | Single vision | When using PC or PC+ Minimum PD ≥ 32.0 mm When using Trivex Minimum PD ≥ 34.0 mm | Single vision | Main line of sight | |
| | | | Single vision HD | | |
| | Varifocals | When using PC or PC+ Minimum PD ≥ 32.0 mm When using Trivex Minimum PD ≥ 34.0 mm | Varifocal Pro Work | min. 20 mm Zero line of sight | |
| | | | Varifocal Optima | min. 17 mm Zero line of sight | |
| | | | Varifocal Optima HD | min. 16 mm Zero line of sight | |
| | Prescription range | | | | |

- ▶ In order to ensure optimum vision, uvex only uses the special uvex anatomic sport glazing. The overview below provides information on the lens options for uvex RX sp frames and uvex RX goggle. Please also ensure the frame fits correctly.
- ▶ Please take into account the specifications relating to the line of sight when determining the vision point.

| Material | | | | | | Extras, optional | | | | | |
|---|---|---|---|---|-----------|------------------|----------|--------------------|------|---|--|
| CR 39 | HI 1.6 | Plastic HI 1.67 | PC | Trivex | Normal AR | Multi AR | Super AR | UV blue protect | Tint | Variomatic brown | |
| ■ | ■ | ■ | ■ | ■ | ■ | ■ | ■ | ■ | ■ | ■ | |
| | incl. hard coating | incl. hard coating only available with SAR | incl. hard coating | incl. hard coating | | | | only HI 1.67 or PC | | only Polycarbonate or Trivex | |
| ■ | ■ | ■ | ■ | — | ■ | ■ | ■ | only HI 1.67 or PC | — | — | |
| ■ | ■ | ■ | ■ | — | ■ | ■ | ■ | only HI 1.67 or PC | — | — | |
| ■ | ■ | ■ | ■ | — | ■ | ■ | ■ | only HI 1.67 or PC | — | — | |
| ■ | ■ | ■ | ■ | ■ | ■ | ■ | ■ | only HI 1.67 or PC | ■ | only Polycarbonate or Trivex | |
| ■ | ■ | ■ | ■ | ■ | ■ | ■ | ■ | only HI 1.67 or PC | ■ | only Polycarbonate or Trivex | |
| ■ | ■ | ■ | ■ | ■ | ■ | ■ | ■ | only HI 1.67 or PC | ■ | only Polycarbonate or Trivex | |
| + 5.0 to - 5.0 dpt. at maximum value cyl. ±2.0 dpt. | + 5.0 to - 5.0 dpt. at maximum value cyl. ±2.0 dpt. | + 5.0 to - 5.0 dpt. at maximum value cyl. ±2.0 dpt. | + 5.0 to - 5.0 dpt. at maximum value cyl. ±2.0 dpt. | + 5.0 to - 5.0 dpt. at maximum value cyl. ±2.0 dpt. | | | | | | + 5.0 to - 5.0 dpt. at maximum value cyl. ±2.0 dpt. | |
| ■ | ■ | ■ | ■ | ■ | ■ | ■ | ■ | ■ | ■ | ■ | |
| | incl. hard coating | incl. hard coating only available with SAR | incl. hard coating | incl. hard coating | | | | only HI 1.67 or PC | | only Polycarbonate or Trivex | |
| ■ | ■ | ■ | ■ | — | ■ | ■ | ■ | only HI 1.67 or PC | — | — | |
| ■ | ■ | ■ | ■ | — | ■ | ■ | ■ | only HI 1.67 or PC | — | — | |
| ■ | ■ | ■ | ■ | — | ■ | ■ | ■ | only HI 1.67 or PC | — | — | |
| ■ | ■ | ■ | ■ | ■ | ■ | ■ | ■ | only HI 1.67 or PC | ■ | only Polycarbonate or Trivex | |
| ■ | ■ | ■ | ■ | ■ | ■ | ■ | ■ | only HI 1.67 or PC | ■ | only Polycarbonate or Trivex | |
| ■ | ■ | ■ | ■ | ■ | ■ | ■ | ■ | only HI 1.67 or PC | ■ | only Polycarbonate or Trivex | |
| + 3.5 to - 3.5 dpt. at maximum value cyl. ±2.0 dpt. | + 3.5 to - 3.5 dpt. at maximum value cyl. ±2.0 dpt. | + 3.5 to - 3.5 dpt. at maximum value cyl. ±2.0 dpt. | + 3.5 to - 3.5 dpt. at maximum value cyl. ±2.0 dpt. | + 3.5 to - 3.5 dpt. at maximum value cyl. ±2.0 dpt. | | | | | | + 3.5 to - 3.5 dpt. at maximum value cyl. ±2.0 dpt. | |
| Material | | | | | | Extras, optional | | | | | |
| CR 39 | HI 1.6 | Plastic HI 1.67 | PC/PC ⁺ | Trivex | Normal AR | Multi AR | Super AR | UV blue protect | Tint | Variomatic brown | |
| — | — | — | ■ | ■ | ■ | ■ | ■ | ■ | ■ | ■ | |
| | | | incl. hard coating | incl. hard coating only available with SAR | | | | only HI 1.67 or PC | | only Polycarbonate or Trivex | |
| — | — | — | ■ | ■ | ■ | ■ | ■ | only HI 1.67 or PC | ■ | only Polycarbonate or Trivex | |
| — | — | — | ■ | ■ | ■ | ■ | ■ | only HI 1.67 or PC | ■ | only Polycarbonate or Trivex | |
| — | — | — | ■ | ■ | ■ | ■ | ■ | only HI 1.67 or PC | ■ | only Polycarbonate or Trivex | |
| | | | + 3.50 to - 3.50 dpt. at maximum value cyl. ±2.0 dpt. | + 3.50 to - 3.50 dpt. at maximum value cyl. ±2.0 dpt. | | | | | | + 3.5 to - 3.5 dpt. at maximum value cyl. ±2.0 dpt. | |



Prescription safety spectacles

Focustypes

Single vision lenses

Single vision lenses correct long and short-sightedness.

Multi-focal lenses

In addition to correcting distance vision, multi-focal glasses correct long-sightedness and also correct intermediate distances, if applicable.

Multi-focal glasses are required when the eyes are no longer able to adjust easily due to the natural aging process. Small objects, just in front of the eye, are no longer clearly discerned (so-called age-related long-sightedness, presbyopia).

Bifocal

Visibly ground segment for near vision ("reading field")
Abrupt transition from distance to near vision at the edge of the segment

Instant wearer acceptance: distinct edge helps eyes to adjust
Intermediate ranges are not corrected

Multifocal

- Gradual transition from distance to near vision, known as progressive lenses
- Invisible progression also corrects in-between distances
- Clear vision at all viewing distances
- May require an initial phase of adjustment

uvex HD lenses

uvex HD lenses – maximum individuality

uvex optima prescription lenses in the so-called free-form design are produced specially for you. The inner surface of the raw lenses is calculated and produced taking into account your individual prescription, the glass curve and your eye measurements (distance between the eyes and fitting height).

Further individual parameters such as corneal vertex distance, face form-wrap and pantoscopic tilt are also taken into account. Special programs have been developed to map thousands of individual points on the inside of the lenses. The results are directly incorporated into the customised uvex optima HD lenses. Greater customisation is not possible.

uvex optima HD lenses are available in the single vision HD and varifocal Optima HD designs.

Selected optical associates or your uvex optical consultant will determine the individual measurements for you.

Comfort lenses

Comfort lenses are mainly used at computer workstations. Invisibly integrated correction areas ease the strain on the eyes when looking at near and intermediate distances (so-called accommodation support).

The visual requirements in many other working environments are also limited to areas, which are just in front of the eye up to a few meters away.

Comfort lenses are a good alternative, if the prescription safety spectacles are only used at workstations and distance vision (> 5 m distance) is mainly not necessary.

Nahcomfort Standard, Nahcomfort Optima

- Perfect solution for working distances between 30 cm and around 2 m
- The medium range of the lens surface is determined by the degression chosen and is designed for a distance of ca. 60 to 80 cm.
- Three versions available, depending on the required prescription for reading distance (addition) and the age of the wearer
- All that is needed to place an order are details of the close-range values and the required design (type A, B, C)
- When ordering the Nahcomfort Optima option, the inner surface of the raw lenses are calculated and manufactured, taking into account the correction, the glass curve and the distance between the eyes

| Type A | Type B | Type C |
|--------------------------|--------------------------|--------------------------|
| Degression** 0.75 dpt | Degression** 1.25 dpt | Degression** 1.75 dpt |
| < 50 years | 50 to 55 years | > 55 years |

** Degression: correction reduced, based on the close-range value

Distanzcomfort Optima

Perfect solution for working distances between 30 cm and around 1 m, 2 m or 4 m

By specifying the viewing distance, which is required at the workstation, the correction areas will be calculated individually

All that is needed to place an order are details of the distance and close-range values (addition), the viewing distance (one, two or four metres) as well as the eye measurements (distance between the eyes and fitting height)

Single Vision Relax

- This type of lens is targeted at people over the age of 30.
- An invisibly integrated change to the correction value of +0.5 dpt. in the lower area of the lens eases the strain on the eye when looking at near distances (so-called accommodation support).
- The distance correction remains unchanged
- All that is needed to place an order are details of the distance values and the eye measurements (distance between the eyes and fitting height)
- We recommend Single Vision Relax lenses for professionals, who use mobile devices (notebook, tablet, smartphone etc.) for their daily work.

Prescription safety spectacles

Lens materials · Anti-reflective coating · Tinting

Lens materials

Polycarbonate

Additional labelling: PC

- organic material with very high breaking strength
- only limited resistance to chemicals
- mechanical strength, class "F" (45 m/sec)
- PC+ – polycarbonate with increased centre thickness, specially for uvex RX goggle (see page 339)

Trivex™

- organic material with high breaking strength
- light weight, suitable for even higher prescription values
- excellent optical performance, even for higher prescription values
- excellent resistance to cleaning agents, oils and cosmetics
- good scratch resistance
- best all-round lens material
- mechanical strength, class "F" (45 m/sec)

CR39

Additional labelling: plastic

- Safety spectacles should always be modified otherwise the tensile strength is too low. The middle of the lens must be thicker in order to meet the requirements for tensile strength.
- light weight organic material
- very good optical performance even for high prescriptions
- suitable for working with chemicals and paints/varnishes
- good scratch resistance due to hard layer (optional)
- mechanical strength, class "S" (falling ball test)

HI (high index), organic lens materials with high refractive index

- organic lenses with a refractive index of 1.6 or 1.67 provide better vision (than CR 39)
- the lenses have the required optical efficacy if they comprise less material and the surface is less curved
- the lens is thinner and more aesthetically pleasing
- recommended for a prescription > +/-4.0 dpt.: HI 1.6 recommended for a prescription > +/-6.0 dpt.: HI 1.67
- mechanical strength, class "S" (falling ball test)

Hardened glass

Additional labelling: silicate, mineral glass, glass

- Safety spectacles should always be modified otherwise the tensile strength is too low. The tensile strength is increased through thermal or chemical hardening treatments.
- mechanical strength, class "S" (falling ball test)
 - highly scratch-resistant surface
 - suitable for working with chemicals and paints/varnishes
 - heavy weight, not recommended for prescription values greater than +/-4.0 dpt
 - spark penetration when welding or grinding
 - implosion with liquid metals

Anti-reflective coating

Anti-reflective coating is applied to the inside and outside of lenses by vapour deposition. It significantly reduces reflections on the surfaces, as well as offering an aesthetic advantage and reducing light transmission.

- 3 qualities are available:
- Normal anti-reflective coating
 - Multiple anti-reflective coating
 - Super anti-reflective coating

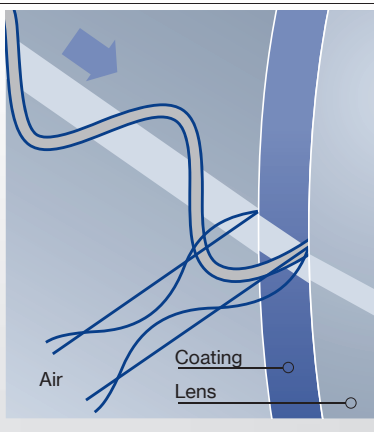

UV blue protect

Lens material with special absorber, which filters UV-radiation completely and reduces blue light.

- the lenses absorb UV-radiation up to 400 nm at 100%, filter short-wave, blue light until 410 nm almost completely and reduce the range from 410 nm to 420 around 86%
- uvex UV blue protect lenses are contrast enhancing and prevent eye fatigue and also prevent age-related macular degeneration (AMD)
- the mechanical strength of the lenses is ensured, clear lenses with uvex UV blue protect will have the marking 2C-1,2
- uvex UV blue protect is optionally available for lens materials Polycarbonate (PC) and HI 1,67

Tinting

Tinted lenses provide effective protection against glare in areas with high light intensity (for example, sunlight).

Constant tinting

- available in brown and grey
- tinting levels: 15%, 25%, 65%, 75%

Variable tinting – Variomatic™

- lenses tint automatically, depending on the intensity of the UV radiation and temperature
- tinting of between approx. 8% and 80%, in brown
- Polycarbonate and Trivex™ prescription safety lenses

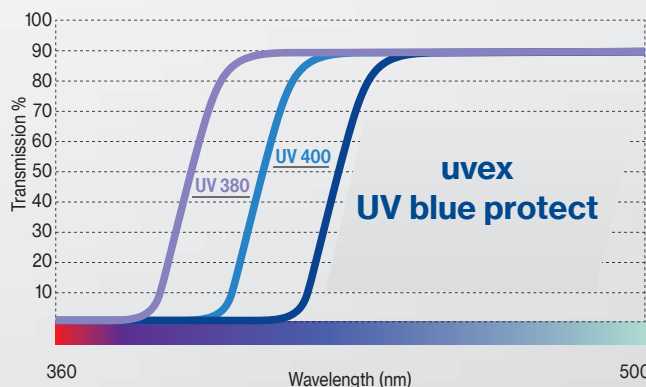

Prescription safety spectacles

Certification and labelling

The frames and lenses of tailor-made prescription safety spectacles in accordance with European standard 166 must feature a permanent mark.

Independent testing institutes carry out certification of the materials at regular intervals.

Frames and lenses must be marked with the manufacturer's identification and the mechanical strength, and the lenses must also be marked with the optical quality class.

The different methods used to test mechanical strength vary according to the lens material. The test methods are defined under European standard EN 168.

If the mechanical strength level marked on the lens differs from that on the frame, the lower mechanical strength applies to the eye protection as a whole.

NB: due to marking requirements, it is not possible to purchase frames without lenses. Please do not modify any feature of the complete spectacles obtained from uvex as this may reduce their protective function.

Basic requirements in accordance with EN 166 (extract)

• Mechanical strength

| Increased robustness | Impact resistance, low energy | Impact resistance, medium energy |
|--|--|---|
| Ball bearing drop test, Dropping a ball bearing (44 g) against the lens/supporting frame from a height of 1.30 m | Firing a ball bearing (0.88 g) against the lens/supporting frame, Impact speed 45 m/s (≈ 162 km/h) | Firing a ball bearing (0.88 g) against the lens/supporting frame, Impact speed 120 m/s (432 km/h) |
| Identification class: S | Identification class: F | Identification class: B |

Additional requirements in accordance with EN 166 (extract)

- Resistance to liquids (droplets and splashes)
Labelling: 3
- Resistance to coarse dust (grain size > 5µm)
Labelling: 4

Optional requirements in accordance with EN 166 (extract)

- Mechanical strength tested under extreme temperatures (+50°C and -5°C)
Labelling: T
This labelling is always in combination with mechanical strength (for example, FT).

Marking according to EN 166

| Lens marking | | | |
|-----------------------------|---|---|---|
| Manufacturer identification | Optical grade | Mechanical strength | |
| W = uvex | 1 | S = Increased robustness F = Low-energy impact (45 m/sec.) B = Medium-energy impact (120 m/s) | <p>W 1 F CE</p> <p>Conformity sign Mechanical strength Optical grade Manufacturer identification</p> |
| Frames marking | | | |
| Manufacturer identification | Mechanical strength | Applicable EN standard | |
| W = uvex | S = Increased robustness F = Low-energy impact (45 m/sec.) B = Medium-energy impact (120 m/s) | 166 | <p>W F 166 CE</p> <p>Conformity sign EN standard Mechanical strength Manufacturer identification</p> |

► “F” constitutes the highest mechanical strength class which a pair of spectacles can be allocated according to EN 166.

uvex i-3 add

Perfect vision in every situation

Optimum protective eyewear means improved, safe vision.

uvex i-3 add safety spectacles have invisible integrated dioptr correction for near vision. Strain on the eyes is effectively reduced (e.g. when reading) and the patented lens technology ensures an instant high level of compatibility for wearers. At the same time, the uvex i-3 add spectacles provide secure protection and optimal comfort.



Variable side arm inclination

The 5-position side arm inclination allows individual adjustment and optimum coverage of the eyes.



Addition

Two models are available for individualised correction of near vision. (+1.0 dpt. and +2.0 dpt.)



Flexible nose loops

The extremely soft adjustable Softflex nose loops ensure a secure fit and can be individually adapted to sit comfortably on the nose.

uvex supravision excellence

The uvex supravision excellence coating guarantees extreme scratch resistance on the outside and permanent anti-fogging properties on the inside.

MADE IN GERMANY

Patent no.: DE 10 2012 207 384

Perfection in every detail

The patented lens technology makes it possible to integrate two progression zones for near vision on the inside of the duospherical single lens safety spectacles. The correction strength at the bottom of the lenses is +1.0 or +2.0, depending on the model. A distinctive feature and unique selling point is that the patented manufacturing technology means the front area and consequently the base curve of the lenses are not altered.

This combines extremely good coverage and fit, all the way to the edge, together with the benefits of a progressive lens on the inside area. A further benefit is that the progressive zone is not visible and that these spectacles comply with all standards of EN norms that are relevant to safety.

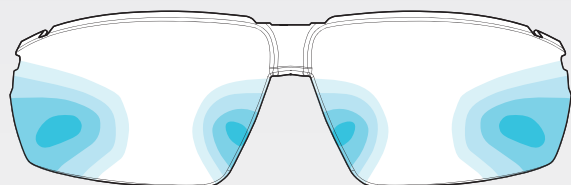

optical lens designed by **optiswiss**
original since 1937

Progression zones

This diagram of the lenses shows the large zone that does not feature any optical correction. The transparent, integrated optical correction starts in the region of the middle and the strength increases gradually towards the lower edge of the lenses. The correction strength of the spectacles is +1.0 or +2.0, depending on the model. The free-form lens is manufactured in accordance with standard parameters and designed for a distance of approximately 64 mm between the eyes. These safety spectacles do not permanently replace prescription safety spectacles.

uvex i-3 add

| | | |
|-------------------|-----------------------------|-----------------------------|
| | uvex i-3 add 1.0 | uvex i-3 add 2.0 |
| Art. no. | 6108210 | 6108211 |
| Frame | anthracite, lime | anthracite, lime |
| | W 166 FT CE 0196 | W 166 FT CE 0196 |
| Lens | PC clear | PC clear |
| | UV 400 | UV 400 |
| | 2C-1.2 W 1 FTKN CE | 2C-1.2 W 1 FTKN CE |
| | uvex supravision excellence | uvex supravision excellence |
| Strength | 1.0 dpt. | 2.0 dpt. |
| Order unit | PC | PC |



Including soft spectacles case with microfiber cloth

VDU spectacles

Spectacle lens technology and body posture at VDU workstations

The positioning of screen, keyboard and reading materials at office workstations can cause vision related problems.

To be able to focus properly at different distances, spectacle wearers adopt an unnatural head position and body posture, which can lead to posture-related discomfort.

As you become older, it becomes increasingly difficult for the lens within the eye to adjust to various distances.

Working in front of a VDU or performing other activities that involve alternating between different distances frequently causes fatigue as a result of the constant strain to the eye.

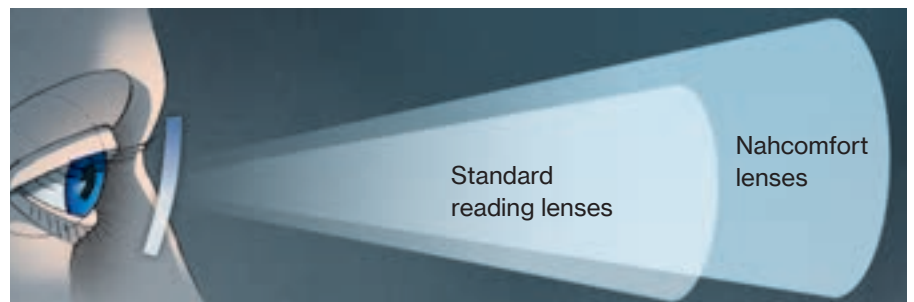

The diagrams and explanations above outline the differences between the various lens options; the potential affect on the wearer and how the Nahcomfort overcomes many of the issues experienced by those working at a VDU or computer.

Varifocal lenses

Varifocal lenses are designed to give the wearer focused vision from 40 cm onwards. However, to see the computer screen clearly through the middle and lower areas of the lense, the wearer has to change their normal head posture and hold their head at an unusually high angle. This can result in permanent straining of the shoulder and neck muscles.

Single-vision lenses

Single-vision lenses, as used in standard reading glasses, enable the wearer to see clearly at a normal reading distance of between 30 cm and 40 cm, which is the ideal distance for keyboards or printed documents. However, if an employee also wishes to see the computer screen and the surrounding area clearly, it is necessary to lower the head and look over the top of the reading glasses. This unnatural head posture puts a severe strain on the shoulder and neck muscles.

Nahcomfort lenses

Nahcomfort lenses are specially designed to suit computer-based workplaces and provide unrestricted vision at VDU workstations.

The advantages are:

- seamless focused vision from 30 cm to approx. 2 meters
- the head remains in an ideal position allowing keyboards, computer screens and work documents to be seen clearly
- a marked reduction of posture-related complaints, because the head and neck remain in a natural position

VDU spectacles

Nahcomfort lenses

Nahcomfort lenses are developed for those working in front of a computer monitor or undertaking work that requires frequently alternating between distances of approx. 30cm and 2m. The unique design facilitates unimpaired vision in the essential focal zones.

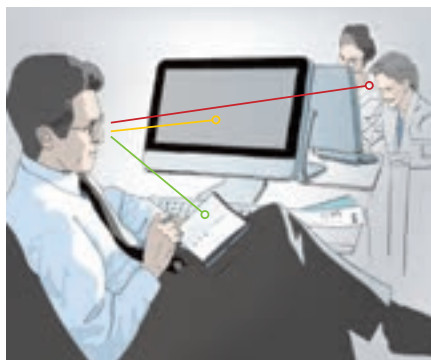

Lens design

- The wearer's usual reading prescription is found in the lower part of the lens.
- The reading prescription gradually becomes weaker further up the lens; in the upper part of the lens, vision is clear at a maximum of approx. 2m.
- The transitions between the different zones are smooth, similar to varifocal lenses.

Advantages of Nahcomfort lenses

- seamlessly sharp vision at distances of approx. 30cm to 2m (the distance is a guideline and may vary depending on the prescription)
- a more comfortable field of vision in the individual zones in comparison with varifocal lenses
- a more natural head position is achieved at the work station, this helps to reduce posture-related complaints, such as tension in the neck muscles

Lensmaterial/style

| Nahcomfort Standard | Nahcomfort Optima |
|---|--|
|  |  |
| Choice of CR 39 or Silicate | Optimised design of the vision zones, very comfortable style, available in CR 39, HI 1,6, HI 1,67 oder HI 1,74 |

Lens type

When selecting the lens type, the wearer's required reading "addition" (reading prescription) and/or the "degression" (reduction of the reading prescription towards the top of the lens) is taken into account.

Alternatively, the age of the wearer can be used as a point of reference.

▼
Please specify lens type, material and desired model with order.

| | Type A | Type B | Type C |
|-----------------|----------------|-------------------|----------------|
| Degression | 0.75 dpt. | 1.25 dpt. | 1.75 dpt. |
| Addition | < 1.5 dpt. | 1.75 to 2.25 dpt. | > 2.25 dpt. |
| - alternatively | Age < 50 years | Age 50 - 55 years | Age > 55 years |

Anti-reflection

We recommend anti-reflective lenses for work at a VDU. An anti-reflective metal oxide coating is applied, which ensures a significant reduction in reflections on the inner and outer sides of the lens.

This increases the light transparency of the lens and vision clarity is improved. Vision discomfort as a result of reflections is reduced.

| Normal anti-reflective | Super anti-reflective |
|---|--|
| Good reflection reduction | Maximum reflection reduction |
| Metal oxide is applied once to each surface | Metal oxide is applied several times to each surface |
| Residual reflection ≈ 4% | Residual reflection < 2% |

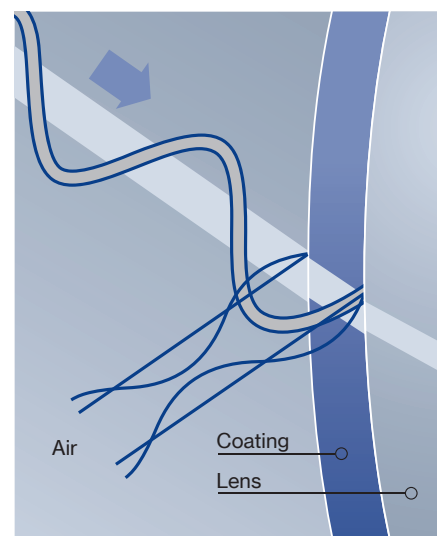

UV blue

The multi-layered surface of uvex UV blue includes a layer that provides enhanced filtration of short-wave visible light in the blue-violet range.

Providing effective protection against the symptoms of fatigue and headaches associated predominantly with long periods of working at a monitor and/or with digital media.

The uvex UV blue layer system also includes a super anti-reflective coating and a scratch-resistant coating.



VDU spectacles

Metal frames



3111 1172 59/17



3114 1000 52/16



3115 4000 54/16



3116 5500 53/17



3117 1590 48/20



3118 7190 55/17

| | | | | | | |
|----------------------|-----------------|-----------------|-----------------|-----------------|-----------------|-----------------|
| | uvex 3111 | uvex 3114 | uvex 3115 | uvex 3116 | uvex 3117 | uvex 3118 |
| Art. no. | 6110049 | 6110052 | 6110053 | 6110054 | 6110055 | 6110056 |
| Ref. no. | 3111 1172 59/17 | 3114 1000 52/16 | 3115 4000 54/16 | 3116 5500 53/17 | 3117 1590 48/20 | 3118 7190 55/17 |
| Lens diameter | 59 mm | 52 mm | 54 mm | 53 mm | 48 mm | 55 mm |
| Bridge width | 17 mm | 16 mm | 16 mm | 17 mm | 20 mm | 17 mm |
| Colour | black, khaki | black | bordeaux | brown | grey, vintage | petrol, vintage |

VDU spectacles
Metal frames



3112 1233 54/17



3113 1000 53/18



3106 5100 50/20



3107 1000 55/17



3108 1400 54/18



3103 1400 50/20

| | | | | | | |
|----------------------|-----------------|-----------------------------|-----------------|-----------------|-----------------|--------------------------------|
| | uvex 3112 | uvex 3113 (previously 3104) | uvex 3106 | uvex 3107 | uvex 3108 | uvex 3103 Half-moon spectacles |
| Art. no. | 6110050 | 6110051 | 6110019 | 6110033 | 6110034 | 6110018 |
| Ref. no. | 3112 1233 54/17 | 3113 1000 53/18 | 3106 5100 50/20 | 3107 1000 55/17 | 3108 1400 54/18 | 3103 1400 50/20 |
| Lens diameter | 54 mm | 53 mm | 50 mm | 55 mm | 54 mm | 50 mm |
| Bridge width | 17 mm | 18 mm | 20 mm | 17 mm | 18 mm | 20 mm |
| Colour | black, blue | black | maroon | black | gun | gun |



VDU spectacles

Plastic frames



3510 1025 52/17



3512 1341 52/18



3506 3329 55/16



3508 1000 54/18

| | | | | |
|----------------------|--------------------|-----------------|-------------------|-----------------|
| | uvex 3510 | uvex 3512 | uvex 3506 | uvex 3508 |
| Art. no. | 6110046 | 6110048 | 6110037 | 6110039 |
| Ref. no. | 3510 1025 52/17 | 3512 1341 52/18 | 3506 3329 55/16 | 3508 1000 54/18 |
| Lens diameter | 52 mm | 52 mm | 55 mm | 54 mm |
| Bridge width | 17 mm | 18 mm | 16 mm | 18 mm |
| Colour | black, translucent | anthracite, red | blue, transparent | black |

VDU spectacles
Plastic frames



3513 3000 50/20



3514 5441 49/19



3515 5426 55/18

| | | | |
|----------------------|-----------------|-----------------|-----------------|
| | uvex 3513 | uvex 3514 | uvex 3515 |
| Art. no. | 6110059 | 6110060 | 6110061 |
| Ref. no. | 3513 3000 50/20 | 3514 5441 49/19 | 3515 5426 55/18 |
| Lens diameter | 50 mm | 49 mm | 55 mm |
| Bridge width | 20 mm | 19 mm | 18 mm |
| Colour | dark blue | havanna, red | havanna, matt |



VDU spectacles

Titanium frames · Nylon frames



3900 5500 53/16



2104 1900 54/18



3901 1400 56/17



2105 1174 52/17

| | Titanium frames | | Metal nylon frames | |
|----------------------|-----------------|-----------------|--------------------|-----------------|
| | uvex 3900 | uvex 3901 | uvex 2104 | uvex 2105 |
| Art. no. | 6110057 | 6110058 | 6110024 | 6110043 |
| Ref. no. | 3900 5500 53/16 | 3901 1400 56/17 | 2104 1900 54/18 | 2105 1174 52/17 |
| Lens diameter | 53 mm | 56 mm | 54 mm | 52 mm |
| Bridge width | 16 mm | 17 mm | 18 mm | 17 mm |
| Colour | brown | gun | silver, matt | black, green |



uvex high-fit



uvex high-fit

Tailor-made hearing protection

Noise-induced hearing loss is still one of the most common occupational hazards. It generally develops painlessly and without warning and the risk to hearing and the importance of hearing protection are often recognised too late. Only those who suffer from hearing loss really understand just how essential a good sense of hearing is and that taking protecting it should be a top priority.

Permanent noise in the workplace creates stress, although employees may only be subconsciously aware of it. Stress situations represent an additional source of risk and can lead to a reduced ability to concentrate, which may result in increased personal risk and negatively effect productivity. uvex high-fit hearing protection products are tailor-made devices which are adapted to the auditory canal of the wearer. A perfect, pressure-free fit ensures the optimum level of comfort. Contact with the outer ear is limited, preventing irritation resulting from dust and sweat. A capillary tube ensures adequate ventilation of the auditory canal to relieve any pressure build-up or the risk of not hearing critical messages or instructions.

uvex high-fit otoplastics are equipped with a filter which can be selected according to the prevailing noise situation in the workplace.

All products and protection levels are tested and certified according to EN 352-2.

During a risk assessment carried out by a health and safety professional or external qualified provider, hearing protection products can be categorised as particularly well-suited to use in specific areas of application.

The classifications are defined as follows:

- S – Signal hearing in rail track superstructure construction
- V – Signal hearing in road traffic
- W – Alarm signal hearing, general
- E – Signal hearing for multiple-unit drivers and shunting train drivers in railway operations

E1 – very suitable, particularly for persons with impaired hearing.

E2 – suitable.

Information is supplied with individual products.

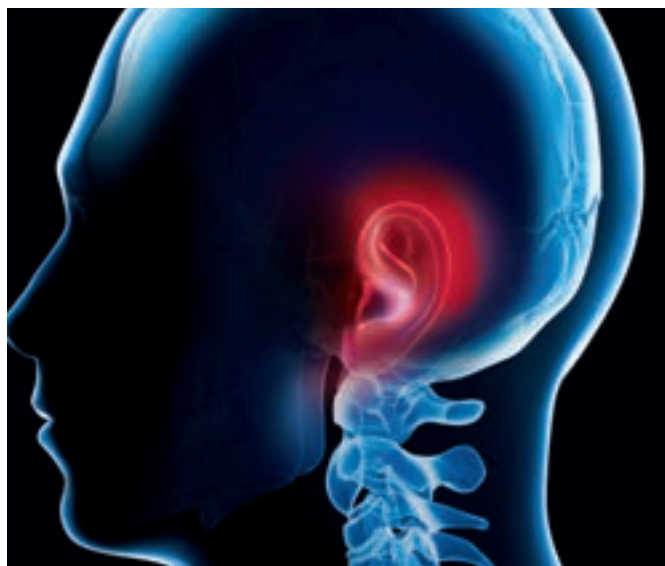

Functional testing

In their prevention guide “Use of hearing protection otoplastics”, the DGUV specifies that a professional functional test must be carried out before otoplastics are first used. They recommend carrying out regular testing at least every three years to ensure that the otoplastics offer the intended level of protection.

Link to prevention guideline:

www.dguv.de

To arrange the functional checks for your uvex high-fit otoplastics, please speak to your uvex contact directly.

Phone: +49 (0)911 9736-1433

Fax: +49 (0)911 9736-1679

email: high-fit@uvex.de

The new PPE Regulation (EU) 2016/425 classifies hearing protection in the highest protection category III. All uvex hearing protection products are subject to this risk category and protect against the risks of harmful noise. There is a duty to provide instruction to employees for products in this category. It is the employer's responsibility to instruct employees accordingly regarding the use of the product. We will be happy to assist you. Please contact your uvex representative regarding this.



Partnership with uvex Summary of your benefits

- customised solution for each member of staff
- legal security based on certified products
- individual advice on products to suit the noise situation in the specific work area
- selection of otoplastic and filter materials adapted to suit the noise situation in the specific work area
- medical history and mould impressions taken locally by trained specialists
- training and information provided on the risks in the workplace
- extensive range of materials and filters
- after-sales service and functional testing offered

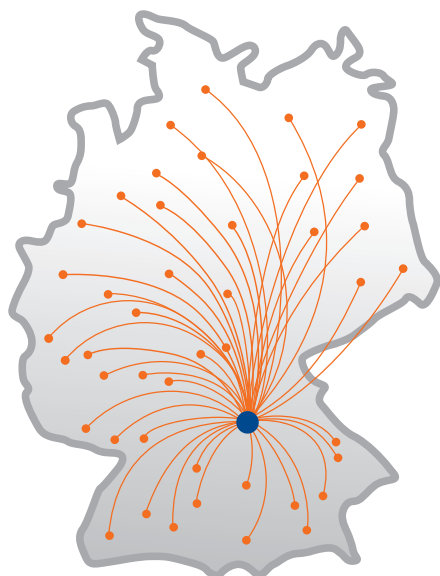

Taking impressions in situ

The individual production of tailor-made otoplastics requires a mould of the auditory canal. uvex staff, or personnel authorised to take the mould impressions on behalf of uvex, have been specially trained by expert audiologists. Attendance at annual refresher courses incorporating a practical module is mandatory.

Procedure for taking the impression:

- Medical history and information on hearing protection
- Otoscope examination of the auditory canal
- Applying the empty mould, filling the auditory canal with the impression substance
- Removing the mould
- Final otoscope check of auditory canal

With individually tailored product solutions, it is particularly important to offer customers an expert local adjustment service, capable of being available on-site as quickly as possible. In addition to personal on-site service by our specialists, uvex has expert partners throughout Germany in acoustic hearing aid clinics to ensure a flexible service.

There are many ways to obtain uvex high-fit hearing protection. We are happy to help in determining the perfect solution for your company. Please contact us.

Phone: +49 (0)911 9736-1433
Fax: +49 (0)911 9736-1679
email: high-fit@uvex.de



The high-fit duro active is a new product developed specifically for people working in very noisy environments that still require communication, regardless of their hearing ability.

high-fit duro active

For people with hearing difficulties, the system can be adapted and tailored to meet their level of hearing impairment.



This means, for example, that the system can be adapted to meet the specific requirements of a person with existing hearing difficulties. An electronic, active hearing protection system with a fully digital high-tech amplifier that uses finely tuned and highly sensitive microphones to provide the best directional and optimal ambient hearing.

The combination of customised otoplastic hearing protection together with our finely controlled amplifier technology ensures the highest level of hearing protection and sound clarity. This means that the high-fit duro can confidently be used up to an exposure level of 112 dB(A).

The high-tech amplifier technology offers outstanding performance with impulse sounds, such as a bang or a shot (up to 164 dB).

The electronic limitation and reopening after the impulse sound takes less than 10 milliseconds.

The CeruStop cerumen filter system protects against moisture and sweat.

The high-fit duro active not only protects the hearing but also assists the wearer in situations where hearing and communication may be difficult, such as communicating in very noisy workplaces or where early detection of quiet sounds is required.

uvex high-fit Industrial otoplastics



6170840

uvex high-fit duro active

- active otoplastic hearing protection – tailor-made to the individual's ear canal
- finely tuned and highly sensitive microphones
- best directional and ambient acoustics
- very high level of passive insulation
- outstanding high-tech amplifier technology for impulse noise
- protection in the event of a shot or bang (up to 164 dB)
- electronic limitation closes in less than 10 milliseconds
- cerumen filter system protects against moisture and sweat
- assists the wearer in situations where hearing and communication may be difficult, such as when communicating in very noisy workplaces or where early detection of quiet sounds is required

Areas of application:

Workplaces with high communication requirements, very loud environments, employees with hearing loss or those affected by impulse sounds

Frequency-dependent attenuation

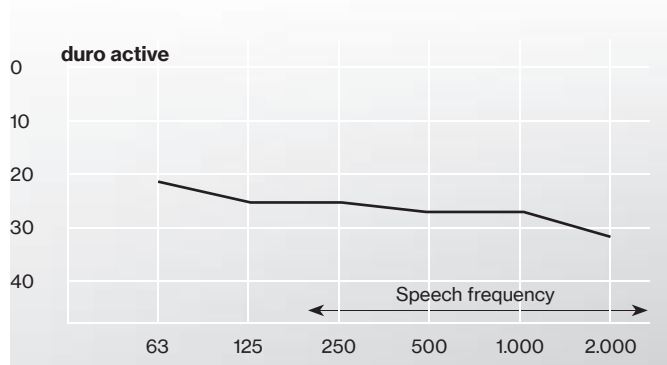

| | |
|---------------------------|--------------------|
| uvex high-fit duro active | |
| Art. no. | 6170840 |
| Norm | EN 352-2, EN 352-7 |
| Standard | 26 dB |
| Colour | black, beige |

| | | | | | | |
|--|------|------|------|------|------|------|
| uvex high-fit duro active (black filter element) | | | | | | |
| SNR 26 dB – H 28 dB M 22 dB L 20 dB | | | | | | |
| f / Hz | 63 | 125 | 250 | 500 | 1000 | 2000 |
| Attenuation / dB | 21.5 | 25.3 | 25.2 | 27.1 | 27 | 31.6 |
| SD / dB | 7.3 | 8.6 | 7.2 | 6.3 | 6.3 | 4.1 |
| APV / dB | 14.2 | 16.7 | 18 | 20.8 | 20.7 | 27.5 |



6177157



6177158



Included

- active otoplastic hearing protection – tailor-made to the individual's ear canal
- hard shell case
- 1 blister pack of zinc-air batteries, size 312
- 1 blister pack of earwax filters
- uvex cleaning cloths for otoplastics
- User information

| | |
|---------------------------------|---|
| Replacement batteries | |
| Art. no. | 6177157 |
| Type | 1 PC blister pack of 6 zinc-air batteries, type 312 |
| Order quantity multiples | 10 PC |

| | |
|---------------------------------|--------------------------------|
| Replacement cerumen filters | |
| Art. no. | 6177158 |
| Type | 1 PC blister pack of 8 filters |
| Order quantity multiples | 5 PC |



uvex high-fit
Industrial otoplastics



uvex high-fit u-cut HC

- half-concha custom otoplastic design
- soft silicone material (dermatologically tested)
- removable otoplastics for the auditory canal offer maximum flexibility; can also compensate for strong jaw movement
- thanks to its unique design, this otoplastic is softer, lighter and more flexible in the auditory canal and on the ear concha for maximum wearer comfort
- with anti-bacterial nano-coating

Areas of application:

- for use in any high-temperature area and by persons with pressure-sensitive ears

| uvex high-fit u-cut HC | | |
|------------------------|-------------|----------------------|
| Art. no. | 6170720 | 6170726 |
| Standard | EN 352 | EN 352 |
| | | S, W, E ₂ |
| SNR | 20 dB | 26 dB |
| Colour | transparent | transparent |

► We will be happy to change the filter element for you if and when necessary.

Frequency-dependent attenuation

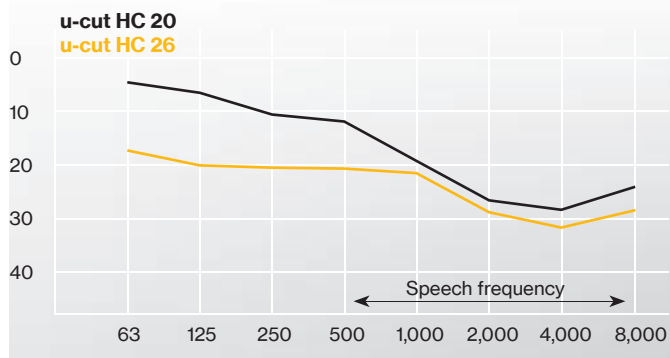

| uvex high-fit u-cut HC 20 (black filter element) | | | | | | | | |
|--|-----|------|------|------|------|------|------|------|
| SNR 23 dB – H 25 dB M 17 dB L 12 dB | | | | | | | | |
| f / Hz | 63 | 125 | 250 | 500 | 1000 | 2000 | 4000 | 8000 |
| Attenuation / dB | 8.8 | 10.1 | 13.1 | 16.3 | 23.0 | 29.7 | 32.5 | 28.9 |
| SD / dB | 4.3 | 3.7 | 2.6 | 4.5 | 3.9 | 3.1 | 4.3 | 4.9 |
| APV / dB | 4.5 | 6.4 | 10.5 | 11.8 | 19.1 | 26.6 | 28.2 | 24.0 |

| uvex high-fit u-cut HC 26 (yellow filter element) | | | | | | | | |
|---|------|------|------|------|------|------|------|------|
| SNR 26 dB – H 25 dB M 23 dB L 21 dB | | | | | | | | |
| Classification: S, W, -, E ₂ | | | | | | | | |
| f / Hz | 63 | 125 | 250 | 500 | 1000 | 2000 | 4000 | 8000 |
| Attenuation / dB | 23.9 | 25.1 | 24.6 | 25.4 | 25.9 | 32.7 | 36.1 | 32.3 |
| SD / dB | 6.7 | 5.1 | 4.3 | 4.8 | 4.5 | 3.8 | 4.4 | 3.9 |
| APV / dB | 17.2 | 20.0 | 20.3 | 20.6 | 21.4 | 28.9 | 31.7 | 28.4 |

uvex high-fit Industrial otoplastics



uvex high-fit u-cut HC

- full-concha custom otoplastic design
- soft silicone material (dermatologically tested)
- removable otoplastics for the auditory canal offer maximum flexibility; can also compensate for strong jaw movement
- thanks to its unique design, this otoplastic is softer, lighter and more flexible in the auditory canal and on the ear concha for maximum wearer comfort
- with anti-bacterial nano-coating

Areas of application:

- for use in any high-temperature area and by persons with pressure-sensitive ears

| uvex high-fit u-cut HC | | |
|------------------------|-------------|----------------------|
| Art. no. | 6170703 | 6170704 |
| Standard | EN 352 | EN 352 |
| | | S, W, E ₂ |
| SNR | 20 dB | 26 dB |
| Colour | transparent | transparent |

► We will be happy to change the filter element for you if and when necessary.

Frequency-dependent attenuation

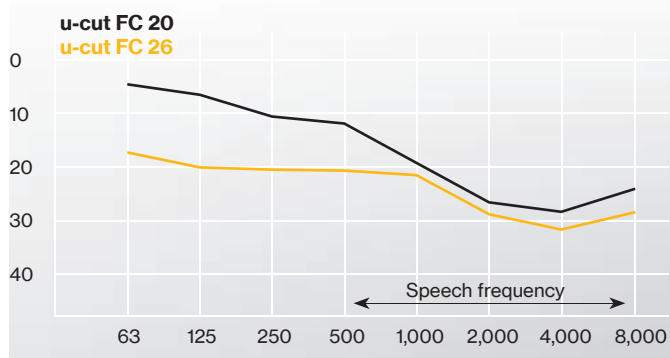

| uvex high-fit u-cut FC 20 (black filter element) | | | | | | | | | |
|--|-----|------|------|------|------|------|------|------|--|
| SNR 20 dB – H 25 dB M 17 dB L 12 dB | | | | | | | | | |
| f / Hz | 63 | 125 | 250 | 500 | 1000 | 2000 | 4000 | 8000 | |
| Attenuation / dB | 8.8 | 10.1 | 13.1 | 16.3 | 23.0 | 29.7 | 32.5 | 28.9 | |
| SD / dB | 4.3 | 3.7 | 2.6 | 4.5 | 3.9 | 3.1 | 4.3 | 4.9 | |
| APV / dB | 4.5 | 6.4 | 10.5 | 11.8 | 19.1 | 26.6 | 28.2 | 24.0 | |

| uvex high-fit u-cut FC 26 (yellow filter element) | | | | | | | | | |
|---|------|------|------|------|------|------|------|------|--|
| SNR 26 dB – H 28 dB M 23 dB L 21 dB | | | | | | | | | |
| Classification: S, W, -, E ₂ | | | | | | | | | |
| f / Hz | 63 | 125 | 250 | 500 | 1000 | 2000 | 4000 | 8000 | |
| Attenuation / dB | 23.9 | 25.1 | 24.6 | 25.4 | 25.9 | 32.7 | 36.1 | 32.3 | |
| SD / dB | 6.7 | 5.1 | 4.3 | 4.8 | 4.5 | 3.8 | 4.4 | 3.9 | |
| APV / dB | 17.2 | 20.0 | 20.3 | 20.6 | 21.4 | 28.9 | 31.7 | 28.4 | |



uvex high-fit
Industrial otoplastics



6170023
6170026
6170028

uvex high-fit flex · uvex high-fit flex detec

- otoplastic hearing protection individually adjusted to the ear canal
- best possible protection due to the perfect fit and a high level of wearer acceptance
- available in different filter strengths
- high level of wearer comfort with soft silicone material
- easy handling with comfortable grip
- antibacterial nano-coating
- detectable variants with a metal ball bearing and a detectable blue cord to ensure they can be found by metal detectors.

| uvex high-fit flex | | | |
|--------------------|-------------|----------------------|----------------------|
| Art. no. | 6170023 | 6170026 | 6170028 |
| Standard | EN 352-2 | EN 352-2 | EN 352-2 |
| | | S, W, E ₂ | S, W, E ₁ |
| SNR | 23 dB | 26 dB | 28 dB |
| Colour | transparent | transparent | transparent |

| uvex high-fit flex detec | | | |
|--------------------------|-------------|-------------|-------------|
| Art. no. | 6170423 | 6170426 | 6170428 |
| Standard | EN 352-2 | EN 352-2 | EN 352-2 |
| | | S, W | S, W |
| SNR | 23 dB | 26 dB | 28 dB |
| Colour | transparent | transparent | transparent |
| Special feature | detectable | detectable | detectable |

► We will be happy to change the filter element for you if and when necessary.

Frequency-dependent attenuation

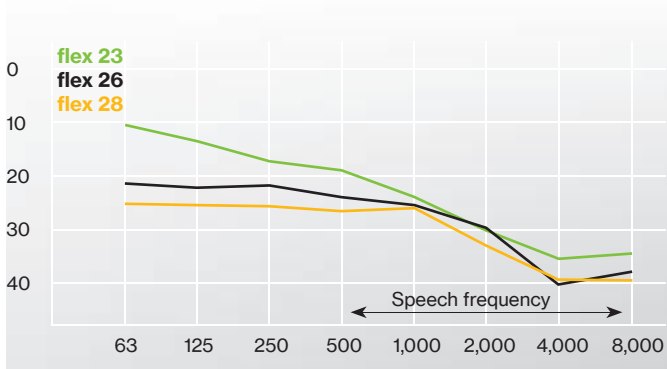

| uvex high-fit flex 23 (green filter element) | | | | | | | | | |
|--|------|------|------|------|------|------|------|------|--|
| SNR 23 dB – H 27 dB M 19 dB L 15 dB | | | | | | | | | |
| f / Hz | 63 | 125 | 250 | 500 | 1000 | 2000 | 4000 | 8000 | |
| Attenuation / dB | 10.5 | 13.7 | 17.2 | 19.0 | 23.9 | 30.5 | 35.6 | 34.4 | |
| SD / dB | 5.2 | 3.9 | 3.4 | 4.0 | 4.1 | 2.7 | 3.8 | 4.9 | |
| APV / dB | 5.3 | 9.8 | 13.8 | 15.0 | 19.8 | 27.8 | 31.8 | 29.5 | |

| uvex high-fit flex 26 (black filter element) | | | | | | | | | |
|--|------|------|------|------|------|------|------|------|--|
| SNR 26 dB – H 28 dB M 23 dB L 20 dB | | | | | | | | | |
| Classification: S, W, ---, E ₂ | | | | | | | | | |
| f / Hz | 63 | 125 | 250 | 500 | 1000 | 2000 | 4000 | 8000 | |
| Attenuation / dB | 21.3 | 22.1 | 21.8 | 24.0 | 25.4 | 29.8 | 40.2 | 37.9 | |
| SD / dB | 5.8 | 4.9 | 3.1 | 3.7 | 2.3 | 4.0 | 2.6 | 6.2 | |
| APV / dB | 15.5 | 17.2 | 18.7 | 20.3 | 23.1 | 25.8 | 37.6 | 31.7 | |

| uvex high-fit flex 28 (yellow filter element) | | | | | | | | | |
|---|------|------|------|------|------|------|------|------|--|
| SNR 28 dB – H 29 dB M 24 dB L 22 dB | | | | | | | | | |
| Classification: S, W, ---, E ₁ | | | | | | | | | |
| f / Hz | 63 | 125 | 250 | 500 | 1000 | 2000 | 4000 | 8000 | |
| Attenuation / dB | 25.2 | 25.4 | 25.7 | 26.6 | 26.0 | 33.0 | 39.3 | 39.4 | |
| SD / dB | 5.2 | 4.4 | 4.7 | 4.2 | 3.5 | 3.4 | 2.9 | 5.5 | |
| APV / dB | 20.0 | 21.0 | 21.0 | 22.4 | 22.5 | 29.6 | 36.4 | 33.9 | |

uvex high-fit Industrial otoplastics



6170223
6170227
6170228
6170231

uvex high-fit flex LS

- otoplastic hearing protection individually adjusted to the ear canal with laser-produced stainless steel filter
- best possible protection due to the perfect fit and high a level of wearer acceptance
- available in different filter strengths
- high level of wearer comfort with soft silicone material
- easy handling with comfortable grip
- antibacterial nano-coating

| uvex high-fit flex LS | | | | |
|-----------------------|-------------|-------------------------|-------------------------|-------------------------|
| Art. no. | 6170223 | 6170227 | 6170228 | 6170231 |
| Standard | EN 352-2 | EN 352-2 | EN 352-2 | EN 352-2 |
| | W | S, W, V, E ₂ | S, W, V, E ₁ | S, W, V, E ₁ |
| SNR | 23 dB | 27 dB | 28 dB | 31 dB |
| Colour | transparent | transparent | transparent | transparent |

Frequency-dependent attenuation

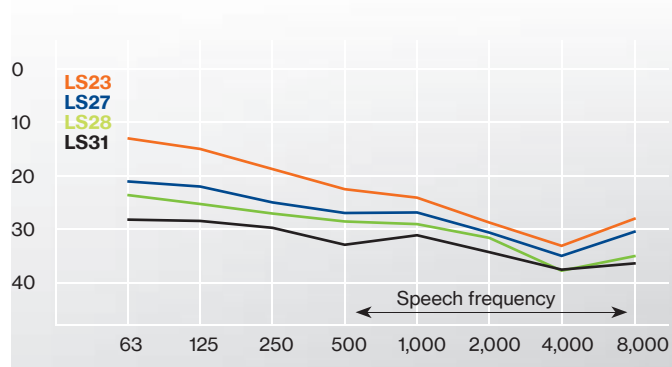

| uvex high-fit flex LS 23 (stainless steel filter) | | | | | | | | | |
|---|-------|---------|---------|---------|----------------------------------|------|------|------|--|
| SNR | 23 dB | H 25 dB | M 21 dB | L 16 dB | Classification: ---, W, ---, --- | | | | |
| f / Hz | 63 | 125 | 250 | 500 | 1000 | 2000 | 4000 | 8000 | |
| Attenuation / dB | 13.0 | 14.8 | 18.6 | 22.4 | 24.0 | 28.7 | 33.1 | 27.9 | |
| SD / dB | 5.2 | 5.4 | 3.1 | 4.0 | 3.6 | 3.3 | 3.7 | 4.4 | |
| APV / dB | 7.8 | 9.4 | 15.5 | 18.4 | 20.4 | 25.4 | 29.4 | 23.5 | |

| uvex high-fit flex LS 27 (stainless steel filter) | | | | | | | | | |
|---|-------|---------|---------|---------|---|------|------|------|--|
| SNR | 27 dB | H 27 dB | M 25 dB | L 23 dB | Classification: S, W, V, E ₂ | | | | |
| f / Hz | 63 | 125 | 250 | 500 | 1000 | 2000 | 4000 | 8000 | |
| Attenuation / dB | 20.9 | 21.9 | 24.9 | 26.9 | 26.8 | 30.6 | 35.0 | 30.4 | |
| SD / dB | 4.9 | 3.0 | 3.6 | 3.3 | 3.2 | 3.4 | 4.1 | 5.3 | |
| APV / dB | 16.0 | 18.9 | 21.3 | 23.6 | 23.6 | 27.2 | 30.9 | 25.1 | |

| uvex high-fit flex LS 28 (stainless steel filter) | | | | | | | | | |
|---|-------|---------|---------|---------|---|------|------|------|--|
| SNR | 28 dB | H 29 dB | M 25 dB | L 23 dB | Classification: S, W, V, E ₁ | | | | |
| f / Hz | 63 | 125 | 250 | 500 | 1000 | 2000 | 4000 | 8000 | |
| Attenuation / dB | 23.6 | 25.2 | 27.0 | 28.5 | 29.0 | 31.6 | 37.8 | 35.0 | |
| SD / dB | 4.3 | 5.3 | 4.3 | 5.6 | 4.5 | 3.7 | 3.6 | 4.6 | |
| APV / dB | 19.3 | 19.9 | 22.7 | 22.9 | 24.5 | 27.9 | 34.2 | 30.4 | |

| uvex high-fit flex LS 31 (stainless steel filter) | | | | | | | | | |
|---|-------|---------|---------|---------|---|------|------|------|--|
| SNR | 31 dB | H 30 dB | M 28 dB | L 26 dB | Classification: S, W, V, E ₁ | | | | |
| f / Hz | 63 | 125 | 250 | 500 | 1000 | 2000 | 4000 | 8000 | |
| Attenuation / dB | 28.2 | 28.4 | 29.7 | 32.9 | 31.1 | 34.3 | 37.6 | 36.4 | |
| SD / dB | 8.0 | 5.5 | 4.5 | 4.0 | 4.8 | 5.2 | 3.6 | 5.6 | |
| APV / dB | 20.2 | 22.9 | 25.2 | 28.9 | 26.3 | 29.1 | 34.0 | 30.8 | |



uvex high-fit
Industrial otoplastics



6170524
6170528

uvex high-fit temp flex

- otoplastic hearing protection individually adjusted to the ear canal
- fully silicone-free
- best possible protection due to the perfect fit and a high level of wearer acceptance
- available in different filter strengths
- easy handling with comfortable grip
- adapts perfectly to the anatomy of the wearer: on insertion, the otoplastic is dimensionally stable; the material gets softer after a few minutes due to the temperature in the ear canal

Areas of application:

- ideally suitable for the paint-processing industry

| uvex high-fit temp flex | | |
|-------------------------|-------------|-------------|
| Art. no. | 6170524 | 6170528 |
| Standard | EN 352-2 | EN 352-2 |
| SNR | 24 dB | 28 dB |
| Colour | transparent | transparent |

- We will be happy to change the filter element for you if and when necessary.

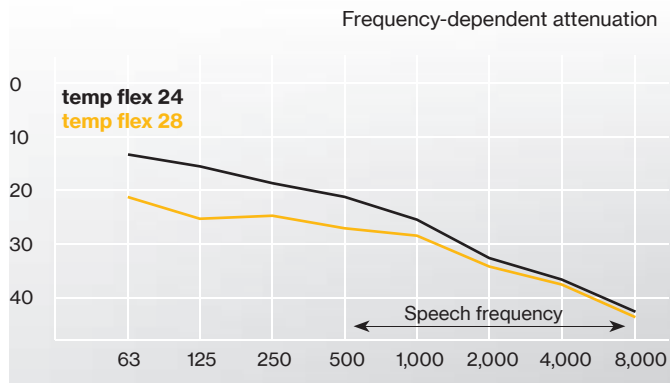

| uvex high-fit temp flex 24 (black filter element) | | | | | | | | |
|---|-------|---------|------|---------|---------|------|------|------|
| SNR | 24 dB | H 28 dB | | M 21 dB | L 16 dB | | | |
| f / Hz | 63 | 125 | 250 | 500 | 1000 | 2000 | 4000 | 8000 |
| Attenuation / dB | 13.1 | 15.5 | 18.5 | 21.1 | 26.3 | 32.4 | 36.5 | 42.4 |
| SD / dB | 3.2 | 5.1 | 4.2 | 3.7 | 5.4 | 3.7 | 4.1 | 3.9 |
| APV / dB | 9.9 | 10.4 | 14.3 | 17.4 | 20.9 | 28.7 | 32.4 | 38.5 |

| uvex high-fit temp flex 28 (yellow filterelement) | | | | | | | | |
|---|-------|---------|------|---------|---------|------|------|------|
| SNR | 28 dB | H 30 dB | | M 24 dB | L 21 dB | | | |
| f / Hz | 63 | 125 | 250 | 500 | 1000 | 2000 | 4000 | 8000 |
| Attenuation / dB | 21.2 | 25.2 | 24.7 | 27.0 | 28.3 | 34.1 | 37.4 | 43.4 |
| SD / dB | 5.5 | 5.7 | 6.0 | 4.9 | 4.9 | 3.2 | 3.5 | 4.2 |
| APV / dB | 15.7 | 19.5 | 18.7 | 22.1 | 23.4 | 30.9 | 33.9 | 39.2 |

Classification: S, W, ---, E₂

uvex high-fit Industrial otoplastics



6170824
6170828
6170832

uvex high-fit duro · uvex high-fit duro detec

- otoplastic hearing protection individually adjusted to the ear canal made from dimensionally stable duroplast material
- fully silicone-free
- detectable variants with a metal ball bearing and a detectable blue cord to ensure they can be identified by metal detectors.
- best possible protection with perfect fit and high level of wearer acceptance
- available in different filter strengths
- smooth, even surface
- easy handling with comfortable grip
- antibacterial nano-coating

Areas of application:

- ideally suitable for the paint-processing industry and for areas with very fine dust
- uvex high-fit flex detec ideally suited for sectors in the food industry

| uvex high-fit duro | | | |
|--------------------|-------------|-------------|-------------|
| Art. no. | 6170824 | 6170828 | 6170832 |
| Standard | EN 352-2 | EN 352-2 | EN 352-2 |
| SNR | 24 dB | 28 dB | 32 dB |
| Colour | transparent | transparent | transparent |

| uvex high-fit duro detec | | | |
|--------------------------|-------------|-------------|-------------|
| Art. no. | 6170424 | 6170418 | 6170432 |
| Standard | EN 352-2 | EN 352-2 | EN 352-2 |
| SNR | 24 dB | 28 dB | 32 dB |
| Colour | transparent | transparent | transparent |
| Special feature | detectable | detectable | detectable |

Frequency-dependent attenuation

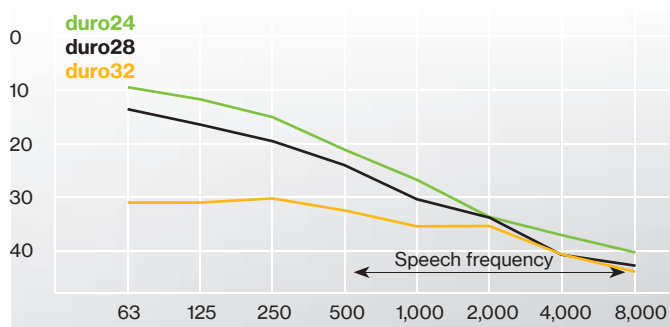

| uvex high-fit duro 24 (green filter element) | | | | | | | | | |
|--|-----|------|------|------|------|------|------|------|--|
| SNR 24 dB – H 30 dB M 21 dB L 15 dB | | | | | | | | | |
| f / Hz | 63 | 125 | 250 | 500 | 1000 | 2000 | 4000 | 8000 | |
| Attenuation / dB | 9.7 | 11.7 | 15.1 | 20.9 | 26.9 | 33.7 | 36.9 | 40.2 | |
| SD / dB | 3.7 | 3.1 | 2.3 | 3.0 | 3.6 | 3.3 | 2.7 | 5.5 | |
| APV / dB | 6.0 | 8.6 | 12.8 | 17.9 | 23.3 | 30.4 | 34.2 | 34.7 | |

| uvex high-fit duro 28 (black filter element) | | | | | | | | | |
|--|------|------|------|------|------|------|------|------|--|
| SNR 28 dB – H 32 dB M 24 dB L 18 dB | | | | | | | | | |
| f / Hz | 63 | 125 | 250 | 500 | 1000 | 2000 | 4000 | 8000 | |
| Attenuation / dB | 13.6 | 16.2 | 19.6 | 24.0 | 30.3 | 33.8 | 40.8 | 42.8 | |
| SD / dB | 3.1 | 4.2 | 3.2 | 3.0 | 3.6 | 3.5 | 2.3 | 4.6 | |
| APV / dB | 10.5 | 12.0 | 16.4 | 21.0 | 26.7 | 30.3 | 38.5 | 38.2 | |

| uvex high-fit duro 32 (yellow filter element) | | | | | | | | | |
|---|------|------|------|------|------|------|------|------|--|
| SNR 32 dB – H 33 dB M 29 dB L 27 dB | | | | | | | | | |
| Classification: S, W, V, E ₁ | | | | | | | | | |
| f / Hz | 63 | 125 | 250 | 500 | 1000 | 2000 | 4000 | 8000 | |
| Attenuation / dB | 31.0 | 31.0 | 30.2 | 32.3 | 35.3 | 35.2 | 40.5 | 43.4 | |
| SD / dB | 5.6 | 6.6 | 4.9 | 6.1 | 6.9 | 3.5 | 3.1 | 5.3 | |
| APV / dB | 25.4 | 24.4 | 25.3 | 26.2 | 28.4 | 31.7 | 37.4 | 38.1 | |



uvex high-fit
Special model



6170315
6170320
6170326

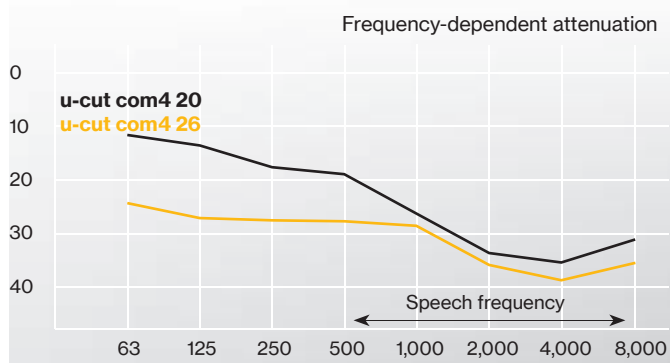

uvex high-fit u-cut com4

- otoplastic hearing protection customised to the wearer's auditory canal
- soft silicone material (dermatologically tested)
- removable otoplastics for the auditory canal offer maximum flexibility
- ideal for leisure activities thanks to small auditory canal design without grip
- with anti-bacterial nano-coating

Areas of application:

- sleeping, flying, shared office spaces, phone calls, concerts, work areas without designated noise areas

Please note that our u-cut com4 model with an SNR of 15 dB is not suitable or certified for use in designated noise areas.

| uvex high-fit u-cut com4 | | | |
|--------------------------|-------------|-------------|-------------|
| Art. no. | 6170315 | 6170320 | 6170326 |
| Standard | EN 352 | EN 352 | EN 352 |
| SNR | 15 dB | 20 dB | 26 dB |
| Colour | transparent | transparent | transparent |

uvex high-fit u-cut com4 20 (black filter element)

| uvex high-fit u-cut com4 20 (black filter element) | | | | | | | | |
|--|-----|------|------|------|------|------|------|------|
| SNR 20 dB - H 25 dB M 17 dB L 12 dB | | | | | | | | |
| f / Hz | 63 | 125 | 250 | 500 | 1000 | 2000 | 4000 | 8000 |
| Attenuation / dB | 8,8 | 10,1 | 13,1 | 16,3 | 23,0 | 29,7 | 32,5 | 28,9 |
| SD / dB | 4,3 | 3,7 | 2,6 | 4,5 | 3,9 | 3,1 | 4,3 | 4,9 |
| APV / dB | 4,5 | 6,4 | 10,5 | 11,8 | 19,1 | 26,6 | 28,2 | 24,0 |

uvex high-fit u-cut com4 26 (yellow filter element)

| uvex high-fit u-cut com4 26 (yellow filter element) | | | | | | | | |
|---|------|------|------|------|------|------|------|------|
| SNR 26 dB - H 28 dB M 23 dB L 21 dB | | | | | | | | |
| Classification: S, W, -, E ₂ | | | | | | | | |
| f / Hz | 63 | 125 | 250 | 500 | 1000 | 2000 | 4000 | 8000 |
| Attenuation / dB | 23,9 | 25,1 | 24,6 | 25,4 | 25,9 | 32,7 | 36,1 | 32,3 |
| SD / dB | 6,7 | 5,1 | 4,3 | 4,8 | 4,5 | 3,8 | 4,4 | 3,9 |
| APV / dB | 17,2 | 20,0 | 20,3 | 20,6 | 21,4 | 28,9 | 31,7 | 28,4 |



6170323

Frequency-dependent attenuation

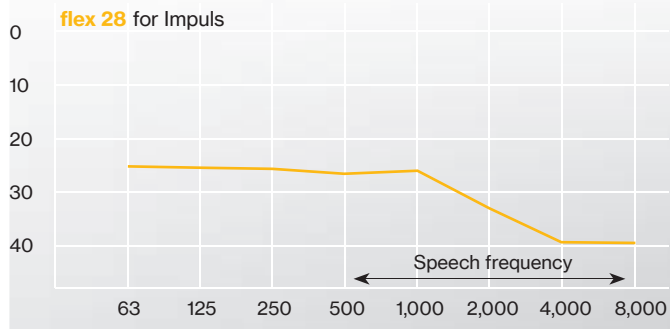

uvex high-fit flex for impulse

- otoplastic hearing protection individually adjusted to the ear canal
- suitable for pulse peaks up to 172 decibels
- best possible protection with perfect fit and high level of wearer acceptance
- high level of wearer comfort due to the soft silicone material
- easy handling with comfortable grip
- antibacterial nano-coating

uvex high-fit flex for impulse

| uvex high-fit flex for impulse | | | | | | | | |
|--------------------------------|----------|--|--|--|--|--|--|--|
| Art. no. | 6170323 | | | | | | | |
| Standard | EN 352-2 | | | | | | | |
| | S, W | | | | | | | |
| SNR | 28 dB | | | | | | | |
| Colour | green | | | | | | | |

uvex high-fit flex 28 for impulse noise (yellow filter element)

| uvex high-fit flex 28 for impulse noise (yellow filter element) | | | | | | | | |
|---|------|------|------|------|------|------|------|------|
| SNR 28 dB - H 29 dB M 24 dB L 22 dB | | | | | | | | |
| Classification: S, W, ---, --- | | | | | | | | |
| f / Hz | 63 | 125 | 250 | 500 | 1000 | 2000 | 4000 | 8000 |
| Attenuation / dB | 25,2 | 25,4 | 25,7 | 26,6 | 26,0 | 33,0 | 39,3 | 39,4 |
| SD / dB | 5,2 | 4,4 | 4,7 | 4,2 | 3,5 | 3,4 | 2,9 | 5,5 |
| APV / dB | 20,2 | 21,0 | 21,0 | 22,4 | 22,5 | 29,6 | 36,4 | 33,9 |

► As a rule, we recommend the guidelines of the German Bundeswehr (military) for sports marksmen (from small bore), hunters and shoot supervisors:

otoplastics for impulse noise must be type examination approved SNR value must be at least 26 dB on delivery, checks must be carried out prior to use otoplastics for very loud impulse noise should always be used in combination with appropriate earmuffs. In these circumstances, the earmuffs can be removed to enable communication, as the otoplastics will continue to protect against noises

uvex high-fit Accessories



617712

uvex high-fit band

- neck handle for hearing protection otoplastics in zip-up case
- easy to attach the otoplastic to the band using colour-coded connector sleeves
- no disruptive transmission noise because the band prevents the cord rubbing on clothing
- band significantly relieves strain
- comfortable to wear around the neck during breaks

Areas of application:

- ideal for activities with frequent and/or fast head movements

| | |
|------------|--------|
| Band | |
| Art. no. | 617712 |
| Order unit | PC |



617716

uvex clear otoplastics

- silicone-free towelettes for quick and easy cleaning of hearing protection otoplastic, suitable for all otoplastic materials
- packaging: 30 per box

| | |
|------------------------|----------------------|
| uvex clear otoplastics | |
| Art. no. | 617716 |
| Order unit | PC |
| Contents | 30 towelettes per PC |



617715

uvex click case

- small click case for otoplastics

| | |
|--------------------------|--------|
| uvex click case | |
| Art. no. | 617715 |
| Order quantity multiples | 10 PC |



uvex high-fit

Special features



Colours

uvex high-fit flex, uvex high-fit flex LS, uvex high-fit temp flex and uvex high-fit duro otoplastics are made of transparent materials. They are marked left and right with an engraving for ease of fitting and also come with different coloured cord holders.

For an additional fee, we can produce uvex high-fit flex in green, white, yellow, orange or unobtrusive beige.

On request, we can supply you with uvex high-fit otoplastics made of silicone material in red and/or blue at no additional cost.

Included

uvex high-fit otoplastics are supplied in a zipped case, including textile cord, cleaning rod, cleaning cloths and user information.

Silicone otoplastics are delivered with a tube of audinell gel.

uvex high-fit replacement kits

Standard replacement kit for:

- uvex high-fit flex
- uvex high-fit temp flex
- uvex high-fit duro

| | |
|---------------------------------|--|
| Standard replacement kit | |
| Art. no. | 6177110 |
| Design | consists of an elastic cord 800 mm (anthracite) and a pair of connector sleeves (red/blue) |
| Order quantity multiples | 10 PC |

| | |
|---------------------------------|---|
| Standard replacement kit | |
| Art. no. | 6177156 |
| Design | comprising 900 mm textile cord and a pair of fastening sleeves (red/blue) |
| Order quantity multiples | 10 PC |

Standard replacement kit for:

- uvex high-fit flex com

| | |
|---------------------------------|---|
| Standard replacement kit | |
| Art. no. | 6177210 |
| Design | consists of an elastic cord 800 mm (anthracite) and a pair of connector sleeves (red/blue), sealing plugs (red/blue) and disposable plugs |
| Order quantity multiples | 10 PC |

Detectable replacement kit for:

- uvex high-fit flex detec
- uvex high-fit duro detec

| | |
|---------------------------------|--|
| Detectable replacement kit | |
| Art. no. | 6177111 |
| Design | consists of an elastic cord 800 mm (blue, detectable) and a pair of connector sleeves (blue, detectable) |
| Order quantity multiples | 10 PC |

Detectable replacement kit for:

- uvex high-fit flex com detec

| | |
|---------------------------------|--|
| Detectable replacement kit | |
| Art. no. | 6177211 |
| Design | consists of an elastic cord 800 mm (blue, detectable) and a pair of connector sleeves each (blue, detectable), sealing plugs (red/blue) and disposable plugs |
| Order quantity multiples | 10 PC |



uvex medicare

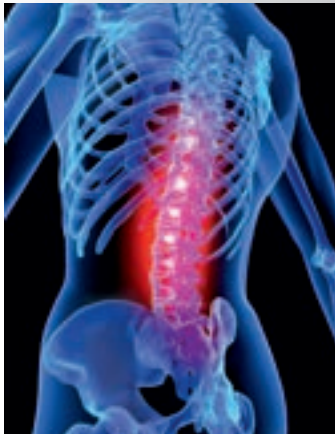
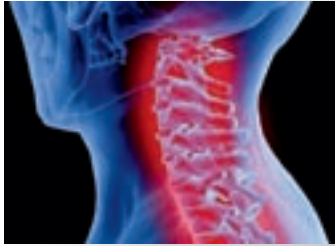
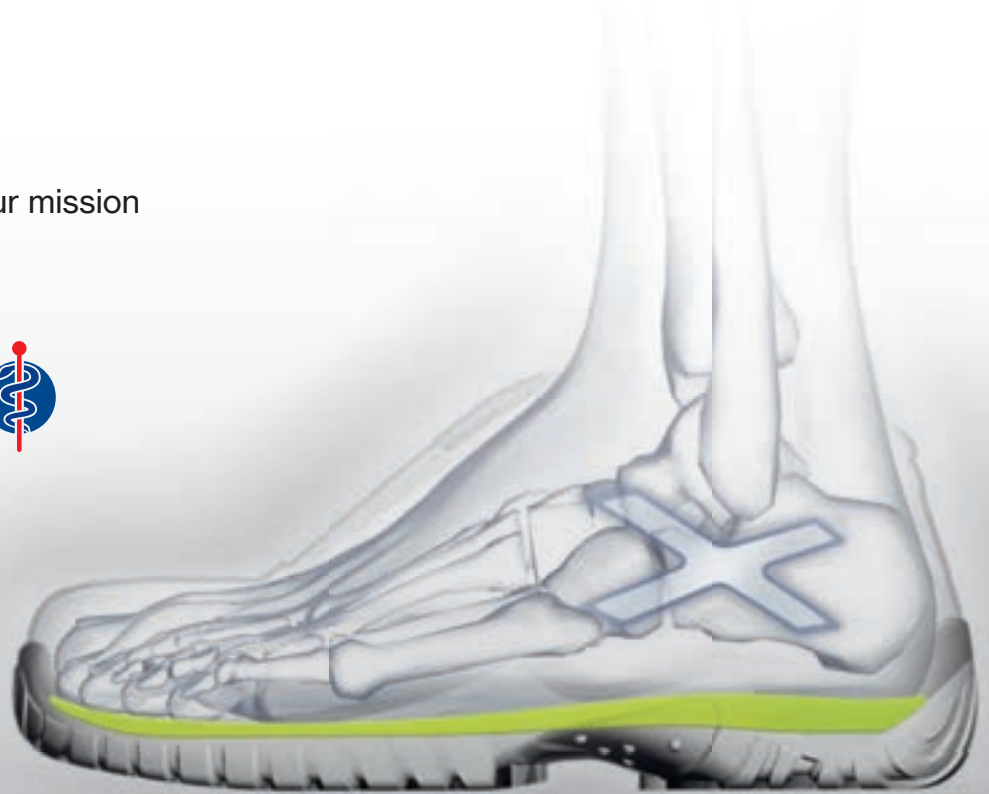

Orthopaedic problems – a widespread phenomenon

As a systems provider and expert manufacturer, uvex is consistently pursuing its protecting people mission in the area of orthopaedics and expanding its spectrum of customised inserts and adjustments for uvex safety footwear.

The customised solutions provided by uvex medicare solve foot-related medical problems in the workplace and offer individual, expertly-designed orthopaedic solutions in uvex safety footwear. This is also accompanied by a comprehensive range of services and support.

Scientific studies prove time and again that well over half the adult population suffer from orthopaedic problems such as fallen arches, knock knees, splay foot or flat feet. These conditions have an undisputed effect on the entire musculoskeletal system and physical performance. However, individuals can significantly benefit from professional customised footwear and insert solutions providing protection for every single employee. Individual. Tailor-made. Safe.

Type examination is a prerequisite – German Social Accident Insurance (DGUV) regulation 112-191 (formerly BGR 191*)

Within the framework of the revised German Social Accident Insurance (DGUV) regulation 112-191 (formerly BGR 191), new, clear guidelines were defined for the use of orthopaedic insoles in safety footwear and individual adjustment of safety footwear. The previous practice of employees providing their own inserts is no longer permissible.

Employers are no longer able to opt out of their duty of care in respect of orthopaedic health and safety.

Significant elements of German Social Accident Insurance (DGUV) regulation 112-191 include a requirement that only fully certified orthopaedic solutions are allowed. This means that no changes made to safety footwear or insoles

may impair the safety characteristics of the footwear and that the entire system must be individually tested. uvex guarantees that its systems are individually tested. Certification gives you the peace of mind that we have used only tested and certified materials and components.



Partnership with uvex Summary of benefits

- tailor-made orthopaedic solutions for individual employees
- developed by specialist orthopaedic footwear manufacturers
- uvex orthopaedic products can provide legal peace of mind
- whether it's customised inserts or shoe adjustments, all uvex orthopaedic solutions offered in combination with uvex safety footwear are certified by accredited testing bodies
- a wide range of uvex safety footwear has been approved for use with uvex medicare orthopaedic solutions, you can create a uniform look throughout your company by introducing a single footwear model
- local adjustment service provided either by a uvex representative or a representative from one of our approved uvex medicare partners
- tailor-made correction service free of charge
- delivery of on-site health awareness workshops for employees
- products supplied with individual documentation detailing all adaptations and in accordance with legal requirements

A strong network Wherever you are

With individually tailored product solutions, it is important to offer customers an expert local adjustment service, capable of being available, on-site as quickly as possible. We work with efficient orthopaedic specialists nationwide to ensure that you will always get the service you need.

The network of approved uvex medicare partners offers not only an expert orthopaedic diagnosis and a range of corrective measures, but can also provide employers with peace of mind, knowing that any product solution they use will conform to the applicable standards and legal requirements.

Our uvex medicare partners will be happy to visit your company by appointment in order to work with you to select and implement the most appropriate safety measures for your employees. Speak to your personal uvex representative about alternative solutions for your company.

The declarations of conformity for uvex medicare certified safety shoes can be found at:

www.uvex-safety.com/en/ce-medicare



uvex medicare

A new dimension in foot protection – uvex motion 3XL

More than just a standard solution

It is quite common for people who have pre-existing foot conditions to struggle with safety footwear, and often their only option is to turn to expensive custom-made solutions. Industrial health and safety experts at uvex have developed the uvex motion 3XL that combines the features of standard safety footwear with custom-made orthopaedic shoes. uvex motion 3XL perfectly combines all the requirements for safety and wearer comfort, making it the professional and practical solution.

uvex motion 3XL: more than just safety footwear

uvex motion 3XL has been specially designed to be highly versatile when used in conjunction with orthopaedic insoles and shoe adjustments. The volume of uvex motion 3XL has ample room for inserting a thick insole, for example, a special diabetic insole.

Optimum safety at work with every step

uvex motion 3XL safety footwear fulfils requirements of S3 shoes in accordance with norm EN ISO 20345:2011.

- Antistatic properties (ESD)
- Oil and fuel-resistant sole
- Energy absorption in heel area
- Water-resistant upper
- Reliable penetration resistance
- Slip resistance (SRC)



uvex motion 3XL offered as full orthopaedic package:

- 1 S3 safety shoe**
- 2 Orthopaedic uvex 3D hydroflex® foam insole with EVA core**
- 3 Padding and construction materials made from soft, conductive EVA**
- 4 Construction elements for individual shoe adjustment**



uvex motion 3XL – a true “space miracle” with unprecedented width

- cost-efficient and practical industrial health and safety solution
- effective reduction of health-related absences
- increased employee wellbeing
- fashionable, sporty design increases wearer acceptance
- a comfortable fit increases wearer acceptance

Use of the uvex motion 3XL in combination with orthopaedic/medical treatment, prophylactic or medical diagnosis (e.g. prevention of diabetes-related subsequent foot problems) must be evaluated and approved by an orthopaedic specialist.

The construction material allows orthopaedic specialists to manufacture customised inserts and shoe adjustments which are valid in accordance with certification and CE markings, e.g. heel spur relief, pronation and supination pads, heel pads, measures required for diabetic foot risk classification types 2-3 and post-operatively.

uvex medicare
uvex motion 3XL



- Dorsiflexion weakness
- Oversensitive skin
- Neuropathy
- Tendonitis
- Tendon contractures
- Muscle weakness
- Hallux rigidus
- Hallux valgus
- Hallux varus
- Gout
- Arthritis
- Heel spur
- Claw toes
- Corns
- Joint blockages
- Joint stiffness
- Joint changes
- Joint inflammation
- Foot deformities



64963



uvex motion 3XL · Shoe S3 SRC

General features:

- extremely wide innovative shoe
- virtually seam-free construction
- pressure points virtually eliminated
- mostly metal-free
- largely free from silicone and plasticiser
- one of the lightest therapeutic safety shoes of its class
- helps to reduce downtime due to ill-health
- offers enough room for diabetes-adapted foot bedding

Protection characteristics:

- meets ESD specifications with bleeder resistor under 35 megaohms
- non-slip outsole and non-metallic penetration-resistant insert – despite high flexibility of the shoe
- 100 % metal-free uvex medi-cap toe cap – compact, anatomically formed, not thermally conductive and with good side stability
- secure standing even on ladders due to optimal profile design with self-cleaning studs and additional stable arch

Comfort features:

- perfect foot climate at all times thanks to breathable lining and outer shoe material
- ergonomic lightweight construction and above-average shock absorption increases wearer comfort and prevents fatigue
- comfortable and virtually pressure-free
- cushioned shaft edge, three-layered padded lining
- customisable complete orthopaedic package
- uvex medicare certified up to 3 cm raised sole
- additional movement space in toe area 1 cm

Areas of application:

- medium area of application, in sectors such as chemical industry, transport and logistics, energy, machine construction and metal processing
- also suitable for therapeutic purposes, e.g. diabetic care

| | |
|------------------|--|
| uvex motion 3 XL | Shoe S3 SRC |
| Art. no. | 64963 |
| Width | > 15 |
| Standard | EN ISO 20345: 2011 S3 SRC |
| Upper material | breathable, water-resistant high-tech microvelour |
| Size | 35 to 50 |



uvex medicare

uvex motion 3XL safety footwear – functionality in every detail

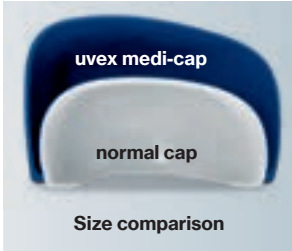

Exceptionally high, anatomically shaped toe cap

The extremely high and wide uvex **medi-cap** ensures sufficient room for deformed feet (e.g. hammer, claw and mallet toes), a splint, an inner shell or a light foot bandage, so the risk of pressure points is reduced. In addition, this model offers good freedom of movement around the toes taking into account the big toe joint.

Secure and adjustable lacing system

Extremely soft, padded tongue with external individually adjustable lacing system.



Soft, elasticated transition

The transition from toe cap to tongue protects the metatarsophalangeal (MTP) joints at the base of the toes.

Increased space
Additional space for movement to reduce pressure points.



All-round cap for impact protection

All-round shoe casing increases protection for wearer and the product life of the shoes.

Metal-free toe cap and midsole

Penetration-resistant sole and toe cap of high-tech plastics fulfil requirements of S3 shoes in accordance with norm EN ISO 20345:2011.

Generous foot width

Considerably wider than size 15. Ample room for inserting a thick insole, e.g. special diabetic insole.



uvex motion 3XL

A true "space miracle"

Minimal seams

To prevent potential rubbing points, the shoes have only three seams which align with the movement direction of the foot. A further feature that reduces pressure points.

Extended heel cap

The heel cap is extended both inside and outside which ensures optimum heel guidance. This improves body static and increases stability.



Padded shoe shaft

Special padding in the collar, ankle and achilles tendon area prevent pressure points.

Maximum comfort

Triple-layer lining with ultra-soft padding.

Complete orthopaedic package

Construction material comprising soft, conductive EVA 6 mm thick foam, in combination with orthopaedic inserts with EVA core.



Where the uvex motion 3XL can help



Diabetes

Oversensitive, dry skin, a tendency for corns, hammer toes and claw toes, through to open wounds with associated neuropathy, which can lead to amputations: People with diabetic foot syndrome are advised to wear optimal footwear. Rule of thumb: The fewer pressure points that the shoe causes on the foot (while still providing the required stability), the more comfortable they are to wear, which reduces and alleviates any existing symptoms.



Foot misalignment or deformations

Whether natural characteristics such as extremely wide or "fleshy" feet, or deformities of the foot that are either congenital or have developed over time due to misalignments or joint changes (e.g. hallux valgus, hallux varus, hallux rigidus): If they are not cushioned by correctly fitted footwear to reduce possible pressure points, they tend to get worse.



Ankle inflammation and osteoarthritis

Disorders in the foot can be caused by ankle inflammation, such as symptoms of tendonitis or diseases such as gout or arthritis. Osteoarthritis of the tarsal or ankle joint also cause chronic pain. Relief can be provided by shoes that guarantee stability with maximum mobility.



Joint blockages, tendon contractures, heel spur

Orthopaedic problems such as joint blockages (in the ankle joint or tarsal bone) and tendon contractures or bone formations such as heel spurs: if they are already sufficiently pronounced, they not only cause chronic pain, but they increasingly restrict a person's ability to move.

Post-operative problems, the effects of operations or accidents at work or while playing sport can often drag on for months or years. The feet are often affected: either directly or indirectly as a result of immobility of the legs in particular. The right footwear ensures that those affected will be able to move again quickly and without pain.



Lower leg problems

Symptoms of paralysis, dorsiflexion weakness, stiff joints or muscle weakness in the lower leg require orthopaedic boots. Stabilising the ankles can prevent those affected from twisting or stumbling, and so avoid further injury.

uvex medicare
uvex motion 3XL sets new standards

66%
more volume

With an internal volume of up to 1,400 cm³, the uvex motion 3XL shoe has space to fit orthopaedic insoles or footbeds adapted for diabetes or even bandages.

Best comparative values

The internal volume of uvex motion 3XL shoe is significantly increased, while the generous width allows for greater wearer comfort. This model is still lighter than many other safety shoes with greater width for deformed feet, splints, inner shell and foot bandages.

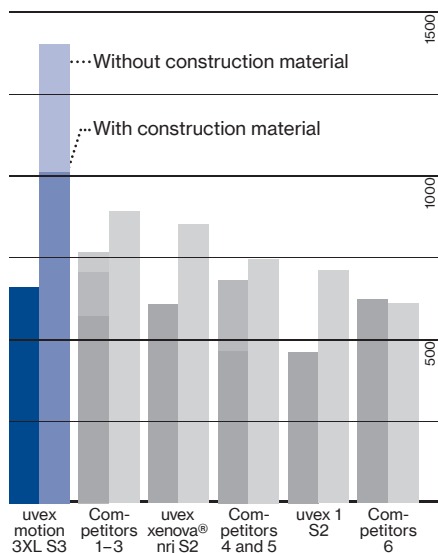

Top of the range in every respect

The uvex motion 3XL with its anatomic design and functionality is one of the best safety shoes in its class, guaranteeing reliable protection and high wear-comfort in every situation.



20%
more width

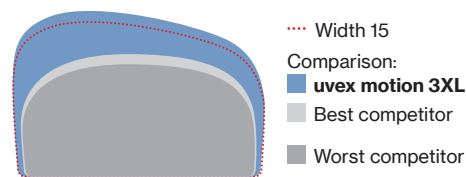

When compared with standard safety shoes, the uvex motion 3XL **width is considerably above 15**, and therefore provides ample room for orthopaedic remedies.

| Shoe, size 42 | Volume (cm ³) | Difference | Width, according to catalogue (mm)* | Difference | Weight (g)* | Difference |
|---|---------------------------|------------|-------------------------------------|------------|-------------|------------|
| uvex motion 3XL S3 with/without construction material | 1010/1400 | | Each >15/287 | | 660/592 | |
| Competitor 1 | 890 | +13% | 14/262 | +10% | 569 | +16% |
| Competitor 2 | 890 | +13% | 12/239 | +20% | 706 | -7% |
| Competitor 3 | 885 | +14% | 12 (up to XXW)/259 | +11% | 766 | -14% |
| uvex xenova® nrj S2 | 850 | +19% | 12/253 | +13% | 606 | +9% |
| Competitor 4 | 750 | +35% | 14/257 | +12% | 464 | +42% |
| Competitor 5 | 720 | +40% | One width/251 | +14% | 681 | -3% |
| uvex 1 S2 | 710 | +42% | 12/244 | +18% | 461 | +43% |
| Competitor 6 | 610 | +66% | No information/245 | +17% | 622 | +6% |

* in accordance with PFI certification



uvex medicare

Comfortable customised inserts – Insert technology for tailor-made treatment

EVA soft-foam technology



uvex 3D hydroflex® foam

- optimum moisture absorption and release
- excellent shock absorption in high-strain zones such as the ball and heel of the foot
- smooth surface
- excellent abrasion resistance

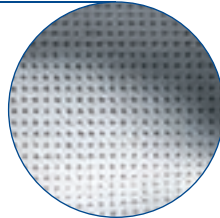

ORTHOPAEDIC ADJUSTMENT

- modular concept
- adapts to assist natural movement

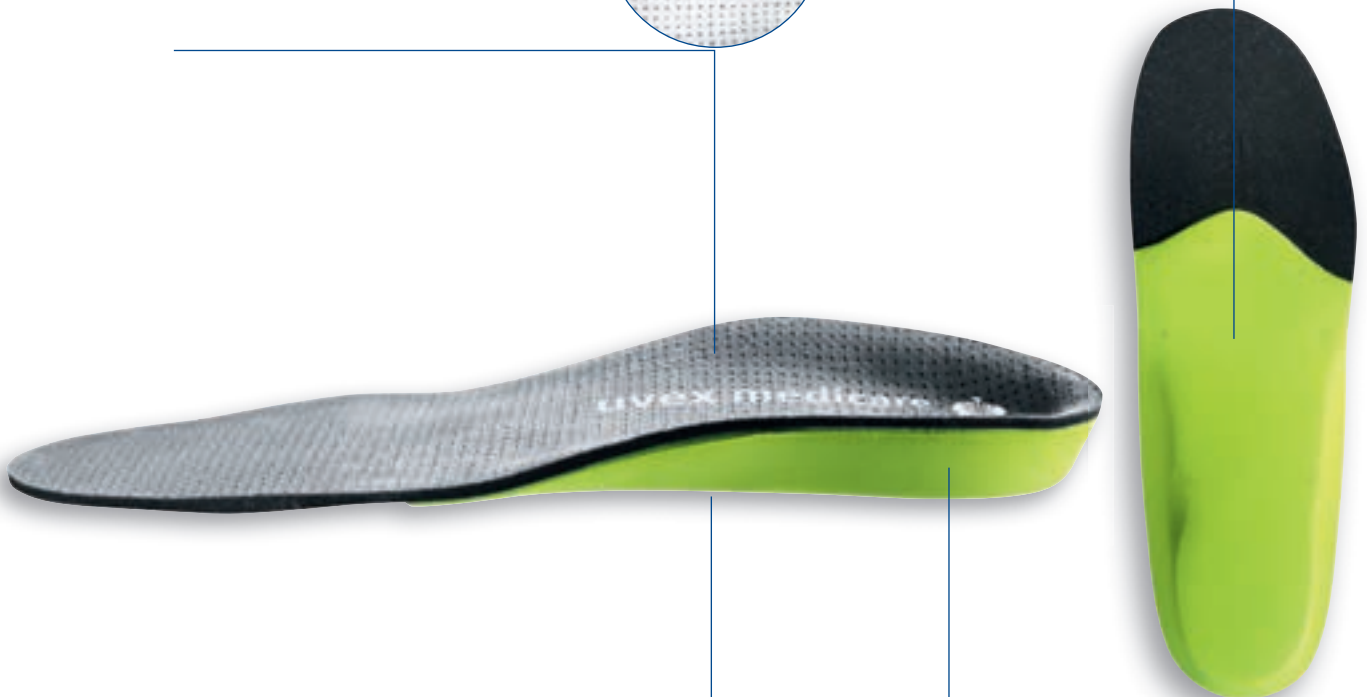

VARIOUS MEDICAL CONCEPTS

Applicable – depending on classification:

- conventional orthopaedics
- sensorimotor function
- Spiraldynamik®
- supports correct bio-mechanical foot rolling
- does not require to be 'broken in'
- high wearer comfort

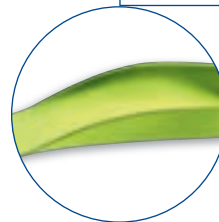
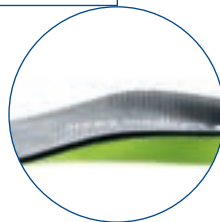

SUPPORTING CORE

- 2 levels of shore hardness (medium/soft) selected according to requirements. Individually adaptable to body type and support requirements
- high support, guiding and shock absorption properties through soft, raised heel shell

Orthopaedic uvex comfort custom insole
Art. no. 6499902



All products suitable for orthopaedic foot protection are indicated in this catalogue with the uvex medicare symbol.

Our orthopaedic uvex customised comfort inserts and orthopaedic shoe adjustments are only certified in accordance with specific safety shoes in each case.

To avoid safety risks, it is essential that you select the right safety shoe for the product (notes in main catalogue). We accept no liability for non-certified combinations. Please do not hesitate to contact us should you have any concerns regarding the right safety shoe.

Our orthopaedic uvex comfortable customised inserts and orthopaedic shoe adjustments are certified in accordance with EN ISO 20345:2011 in combination with uvex safety shoes, which are marked in the uvex catalogue with the uvex medicare symbol.

Orthopaedic shoe adjustments



6499911

Shoe lift

A shoe lift is required to balance legs of different length.

A shoe lift should never exceed 3 cm.



6499913

Roller sole

A roller sole eases the burden on the feet during your stride. The precise effect is governed by the location of the pressure point. This helps adjust the length of your stride.

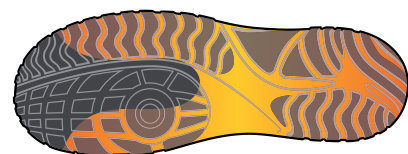

6499914

Butterfly roller

A butterfly roller reduces the burden on sensitive metatarsal bones by dissipating the pressure caused by each stride. By moving the pressure point, you can create an extra rocking effect.

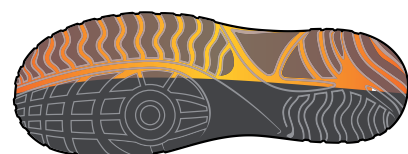
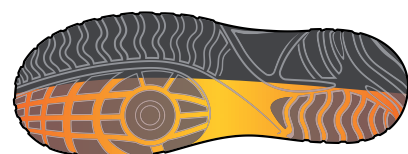

6499915

Outer and inner sole wedges

By using a wedge, you can adjust the slope beneath the feet in a standing position and correct the line of your stride when walking.

| | |
|------------------------------|-----------------------|
| Orthopaedic shoe adjustments | |
| Art. no. | 6499911 |
| Design | orthopaedic shoe lift |
| | up to 1 cm per side |

| | |
|----------|-----------------------------|
| Art. no. | 6499912 |
| Design | shoe lift per additional cm |
| | (up to max. 3 cm) per side |

| | |
|----------|-------------|
| Art. no. | 6499913 |
| Design | roller sole |

| | |
|----------|------------------|
| Art. no. | 6499914 |
| Design | butterfly roller |

| | |
|----------|--------------------------------|
| Art. no. | 6499915 |
| Design | external or internal edge lift |

| | |
|----------|---|
| Art. no. | 6499907 |
| Design | sole stiffener (only as addition in connection with a shoe adjustment initial position) |

The declarations of conformity are available to download at: www.uvex-safety.de/ce-medicare

Note: For shoe adjustments, the temperature resistance of the sole is reduced to 60 °C.

Note: For Austria, the uvex naturform range is not approved in accordance with ÖNORM Z1259. Only "variant A – orthopaedic insert" for model 69608 uvex xenova® hygiene sling is possible in accordance with ÖNORM Z1259.



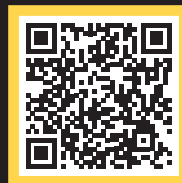

You can find more information at uvex-academy.com

Prescription spectacles and workplace safety

The common key features of prescription safety spectacles are that they compensate the wearer's defective vision and protect the eyes from mechanical and optical influences. This seminar will enable participants to act as a competent representative within the company for prescription safety spectacles right through to fitting.

- Information regarding legal regulations, test specifications and standards
- Sharing knowledge about prescription safety spectacles
- Explanation of the different types of lens and frame materials available, their specific features and properties
- Explanation of the various focus types and their best use

- Assessment of the risks in the respective workplace and selection of the most appropriate prescription safety spectacles
- Ability to determine the necessary parameters for fitting prescription spectacles
- Practical demonstration of selection, consultation, and fitting of prescription safety glasses
- Instruction regarding the best care and handling of prescription safety spectacles

Target group

Those responsible for the work-related health and safety of employees within a company and/or those who are to fit prescription safety spectacles, such as safety officers, company doctors and their support staff.



For further information and to register visit uvex-academy.com, phone +49 911 9736-1710 or e-mail academy@uvex.de

Flex

Workwear
Protective clothing



uvex workwear

Sustainability

For over 90 years, we have been producing and distributing high-quality products to protect people in sports, leisure and at work. Any company wanting to protect people must accept the responsibility that comes with it. It is exactly this mission that instils our commitment to work sustainably and with social responsibility.

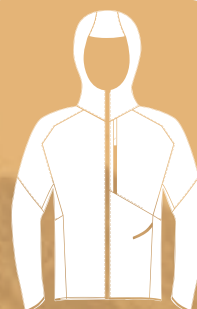

Durable products

In contrast to the current trend for “fast fashion”, our goal is to develop long-lasting products while maximising resource efficiency, so it is of the utmost importance that we use high-quality materials and ingredients. To ensure we do so, we subject our workwear products to our uvex quality standards and regularly test them at our in-house textile test lab to check that they can withstand mechanical stress such as abrasion, cutting and washing. We also send our products to external washing laboratories to confirm that they can be washed in an industrial laundry facility – such products are labelled with “SL” (Suitable for Laundry) in the catalogue. We firmly believe that this effort helps to conserve resources and significantly extends the product life cycle.



Protecting people

OEKO-TEX® STANDARD 100 – uvex hazardous substances list

To succeed in our mission of “protecting people”, we are fully committed to ensuring that our products contain no substances that are harmful to human health. OEKO-TEX® STANDARD 100 certification guarantees that our products have been tested for harmful substances. From the outer shoe material and accessories to even the smallest press stud or label, we ensure from the development stage that every single element of the product can be certified in accordance with OEKO-TEX® STANDARD 100 so that the entire product can also be certified.

In addition to OEKO-TEX®, our materials also meet the requirements of our uvex hazardous substances list, which exceeds legal regulations. We use this list to test our products for hazardous pollutants such as PFCs (perfluorinated compounds), pesticides, heavy metals or phenols, because both protecting people and reducing environmental pollution are core concerns for us.



Manufacturing expertise

In the textile industry, the current norm is to import everything: contrary to this, we continue to trust in products that are made in Europe. As a manufacturer, our responsibilities include design, development, material procurement and production. This is the only way that we at uvex can ensure that everything we produce consistently meets our high quality requirements. We are also a member of the Business Social Compliance Initiative (BSCI), meaning we have pledged to continuously improve living and working conditions on-site for those working on every stage of our supply chain – from production right through to the final product. By sourcing our products in Europe, we can also achieve shorter transport routes, lower CO² emissions and faster availability.



Sustainable materials

Tencel™

Another focus for us is the materials we choose to make our products from. We therefore use Tencel™, a natural fibre made from beech and eucalyptus wood, when we produce our T-shirts. The wood we use comes from sustainable forests that are cultivated in a way that preserves resources – i.e. no additional irrigation and no pesticides.

Recycled polyester

So that we can conserve valuable resources, we use recycled polyester made from empty plastic bottles. The bottles are melted in and spun into new threads, which are used for the production of our materials.

Using recycled polyester reduces our dependence on crude oil and reduces waste.



* Member of amfori, the leading global business association for open and sustainable trade. We participate in amfori BSCI. For more information visit www.amfori.org*



uvex collection 26

The proud feeling of giving your all
for a good cause

Since 1926, uvex has been protecting people at work and in sport. We have incorporated our pride in this task into the sporty collection 26: Its on-trend colours and special materials show the quality with which we are able to combine workwear and casual design.

His and hers. To be worn with pride.

**For more information, visit
uvex-safety.com**



For more information, visit uvex-safety.com



Men's rain jacket

Art. no. 88354 ● saffron S to 4XL

material: 100% polyester, approx. 110 g/m²



Description: • light and functional • small pack size • waterproof zip and hood for rainy days in the city • "high-rise" arm design • breathability MVP 10,000 g/m²/24 h • water column 10,000 mm

Men's functional trousers

Art. no. 88350 ● black 42 to 64, 90 to 110

material: 92% polyamide, 8% elastane, approx. 178 g/m²



Description: • stylish and ultra-light • abrasion-resistant on the outside • soft brushed on the inside • chino shape with intelligent 3D pattern design • pockets with zip

Men's knitted pullover

Art. no. 88356 ● stone grey S to 4XL

material: 100% cotton, approx. 280 g/m²



Description: • with integrated breast pocket • soft and comfortable material • clean look



Beanie

Art. no. 8835800 ● saffron, ● dark blue one size

material: 60% cotton, 40% acrylic, approx. 135 g/m²



Description: • reversible hat in saffron and dark blue • soft and comfortable • for cold days in the city

Ladies' polo shirt

Art. no. 88362 ● black XS to 3XL
Art. no. 88363 ● berry

material: 70% cotton, 30% polyester pique, approx. 200 g/m²



Description: • material mix and casual fit • clean look and tailored fit • OEKO-TEX® Standard 100

Ladies' functional trousers

Art. no. 88351 ● black 34 to 50

material: 92% polyamide, 8% elastane, approx. 178 g/m²



Description: • stylish and ultra-light urban trousers • abrasion-resistant on the outside • soft brushed on the inside • chino shape with intelligent 3D pattern design • pockets with zip

Ladies' sweater

Art. no. 88357 ● berry XS to 3XL

material: 73% cotton, 27% polyester, approx. 280 g/m²



Description: • fitted with clean look • "high-rise" arm design • sporty fit and scoop neck

Men's polo shirt

Art. no. 88360 ● black S to 4XL

Art. no. 88361 ○ white

material: 70% cotton, 30% polyester pique, approx. 200 g/m²



Description: • casual polo shirt in a comfortable material mix • clean loose fit • OEKO-TEX® Standard 100



Ladies' jacket

Art. no. 88353 ● dark blue XS to 3XL

material: 1st outer fabric: 100% nylon

Lining: 100% polyester, approx. 170 g/m²



Description: • warming, wind-resistant and water-resistant • clean urban look • padding for optimal heat insulation • preformed tailored fit for maximum freedom of movement • pockets with zip • breathability MVP 10,000 g/m²/24 h • water column 10,000 mm

Men's parka

Art. no. 88352 ● dark blue S to 4XL

Art. no. 88323 ● olive

material: 1st outer fabric: 100% nylon

Lining: 100% polyester, approx. 170 g/m²



Description: • warming, wind-resistant and water-resistant • clean urban look • padding for optimal heat insulation • preformed cut for maximum freedom of movement • pockets with zip • breathability MVP 10,000 g/m²/24 h • water column 10,000 mm

Ladies' rain jacket

Art. no. 88355 ● saffron XS to 3XL

material: 100% polyester, approx. 110 g/m²



Description: • light and functional with small pack size • waterproof zip and hood for rainy days in the city • "high-rise" arm design • tailored • breathability MVP 10,000 g/m²/24 h • water column 10,000 mm



Ladies trousers

Art. no 89809 ● petrol 34 to 50

Material: 92% polyamide, 8% elastane, approx. 178 g/m²



Description: • sporty, slim-fit with breathable, waterproof and yet elastic material for high comfort • two thigh pockets and a back pocket with zip pullers • PFC free

Men's trousers

Art. no. 89434 ● petrol 42 to 64, 90 to 110

Material: 92% polyamide, 8% elastane, approx. 178 g/m²



Description: • sporty, slim-fit with breathable, waterproof and yet elastic material for high comfort • two thigh pockets and a back pocket with zip pullers • PFC free



Quilted gilet

Art. no. 89449 ● petrol XS to 4XL

Material: 100 % polyester, approx. 65 g/m²
Lining: 100% polyester, Filling: approx. 120 g/m²



Description: • warm yet light • with high-quality stitched logo on the left sleeve • side pockets with discreet zip puller and a Napoleon pocket with zip puller • PFC free

Sweat jacket

Art. no. 89447 ● petrol XS to 4XL

Material: 50 % cotton, 50 % polyester, approx. 330 g/m²



Description: • casual streetwear look in sporty fit with adjustable hood • high-quality stitched logo on the left sleeve

Polo shirt

Art. no. 89458 men

● petrol

XS to 6XL

Art. no. 89459 woman

● petrol

Material: 60% lyocell,
40% polyester
approx. 220 g/m²



Description: • durable Tencel™ material with optimal humidity management • high-quality stitched logo on the left sleeve • row of 3 buttons (89458) • row of 4 buttons (89459)

Softshell jacket

Art. no. 89657

● petrol

XS to 4XL

Material: Exterior: 85% polyamide, 15% elastane
Interior: 100% polyester
Trim: 88% polyester, 12% elastane
approx. 330 g/m²



Description: • functional material combination • Powerstretch areas enable high breathability and comfort during movement • four large front pockets, two breast pockets and an upper arm pocket each with zip puller • OEKO-TEX® standard 100



Cap

Art. no. 8945100

● black

one size

Material: 100 % cotton



Description: • straight peak with contrasting underside
• adjustable size for optimal fit

Quilted jacket

Art. no. 89448

● petrol

XS to 4XL

Material: 100% polyester, approx. 65 g/m²
Lining: 100% Polyester, Filling: approx. 120 g/m²



Description: • warm yet light • with high-quality stitched logo on the left sleeve • side pockets with discreet zip puller and a Napoleon pocket with zip puller • PFC free

Bermuda

Art. no. 89438

● petrol

42 to 64

Material: 92% polyamide, 8% elastane,
approx. 178 g/m²



Description: • sporty slim-fit with waterproof yet elastic material for high comfort • two thigh pockets and one back pocket with zip pullers • PFC free



uvex suXXeed

Some call it fit,
functionality, style.
We call it success

The uvex suXXeed collection gets everything spot on: well thought-out functionality, sporty design, exciting colour contrasts, unusual material combinations and a cut that fits like a glove. The result looks equally good on men and women – and it can be worn in industrial and metal processing settings as well as for leisure. uvex suXXeed equipment keeps up with the demands of every application and every movement. The men's trousers are now available in either slim or regular fit. Our goal is to achieve an absolutely perfect fit, and it's an indispensable part of our recipe for success. The best fit, no compromises – at work and at play.



Video



For more information, visit
uvex-safety.com



uvex perfeXXion

First colourfully mixed,
then washed clean.

Horticulture and landscaping, wood processing or facilities management: all choose uvex perfeXXion.

And uvex perfeXXion leaves the choice open to all. For this robust collection not only offers X different colour versions, but also X different equipment details: Depending on requirements, the different tops and trousers can be freely combined and colourfully mixed. In any situation, the material is extremely hard-wearing. And – most importantly – all items are machine-washable.

For more information, visit
uvex-safety.com



uvex handwerk – profisystem metall

When you have no fear of sparks,
you can conquer any metal

Glowing chips, hot sparks at several hundred degrees, ear-splitting screeching – the risks associated with angle grinding are as big as the spectacular fireworks it creates.

During the development of this workwear and protective clothing, we worked closely with many metal companies and incorporated expert knowledge from practical experience into the development of our products. This resulted in customised solutions: For example, the innovative coating on the clothing, that reliably protects against sparks and leaves no room for any traces of wear. Whether for welding, milling, flexing or assembly: award-winning uvex clothing can be individually adapted to the different activities of metalworking companies.



reddot design award
winner 2015



GERMAN
DESIGN
AWARD
WINNER
2017

uvex protection metal and uvex metal pro clothing was awarded the famous Red Dot Design Award in 2015.

uvex protection metal was also awarded the German Design Award in 2017.

Cooperation partner
of the Federal Metal
Association



For more information, visit
uvex-safety.com



uvex new worker

Workwear all-rounder
with potential to become a classic

Following on from uvex perfect, we now have uvex new worker – the industry-tested all-rounder collection that's everything at once: functional and comfortable, modern and timeless, sporty and classic.

The fit and stretch zones are extremely ergonomic. The reflective elements and knee pockets are made of tried-and-tested CORDURA® material. The contrast stitching ensures that the striking sporty look is achieved with classic undertones.

For more information, visit
[uvex-safety.com](https://www.uvex-safety.com)



uvex perfect

Create your own combination, just make sure your whole team is wearing the same outfit

The uvex perfect range is extensive. And because all items are designed to coordinate perfectly with each other, everything can be combined perfectly. As varied as the colours and materials might be, so too are possibilities of piecing the right equipment together.

Entire teams can dress appropriately for their respective activities and visually distinguish themselves from each other. For the certified protective clothing that makes up the uvex perfect collection is not only good for your safety – but also for team spirit.



For more information, visit
uvex-safety.com



uvex protection perfect multi function

Protects, eases strain,
sits comfortably and is able to
withstand a lot: Protective clothing,
as varied as a working day

Heat, arc flashes, chemicals: If you work in industry, you're right in the middle of it all and are often exposed to a range of hazards. But whatever the day might bring: Our uvex protection perfect multi-function range offers optimal all-round protection and makes work easier thanks to maximum wearer comfort. Stretch inserts in the back and knee area help with ease of movement, while a high proportion of natural fibres and a robust weave allow the hard-wearing material to breathe.

For more information, visit
uvex-safety.com





For more information, visit uvex-safety.com

uvex cut

Protects when work gets sharp

The uvex cut collection protects against injuries that could be caused by blades, glass plates and sharp-edged workpieces. These hard-wearing tops and trousers are also extremely comfortable thanks to the innovative double-face principle and bamboo TwinFlex® inserts. While abrasion-resistant polyamide and cut-resistant glass fibres on the outside provide maximum protection, the soft bamboo yarn on the inside ensures optimal climate control. And this remains the case even after several industrial cleaning processes.

For more information, visit
uvex-safety.com



uvex



uvex cut quatroflox



uvex cut quatroflox polo shirt

Art. no. 17266 ● black, ● anthracite (sleeves) S to 3XL

material: polo shirt 55% cotton, 45% polyester, 3/4-length sleeves made from cut-protection material in accordance with EN 388: 2003, cut protection class 5, approx. 185 g/m²



Description: • slim fit • made from breathable functional fibres with cut-protection sleeves of the highest cut protection class • panel with three buttons • functional, highly elastic strip in the elbow area • integrated cuffs on sleeves without seams • protection and wearer comfort guaranteed even after repeated washing • cut protection made from Bamboo TwinFlex® material: extremely durable on the outside, pleasantly cool on the inside

uvex cut quatroflox polo shirt

Art. no. 17267 ● black, ● anthracite (sleeves) S to 3XL

material: polo shirt 54% modacrylic, 44% cotton, 2% antistatic fibres, 3/4-length sleeves made from cut-protection material in accordance with EN 388: 2003, cut protection class 5, approx. 195 g/m²



Description: • slim fit • sleeves made from cut-resistant material of the highest cut protection class combined with heat-resistant body material made from breathable functional fibres • panel with three buttons • functional, highly elastic strip in the elbow area • integrated cuffs on sleeves without seams • protection and wearer comfort guaranteed even after repeated washing • cut protection made from Bamboo TwinFlex® material: extremely durable on the outside, pleasantly cool on the inside

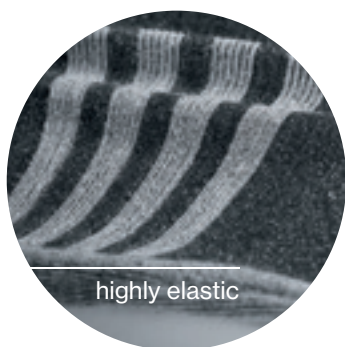

uvex cut quatroflox T-shirt

Art. no. 17268 ● black, ● anthracite (sleeve) S to 3XL
 Art. no. 17269 ● dark grey mix, ● anthracite (sleeve)

material: shirt: 50% cotton, 50% polyester, 3/4-length sleeves made from cut-protection material in accordance with EN 388: 2003, cut protection class 5, approx. 160 g/m²



Description: • slim fit • made from single-jersey fabric with cut-protection sleeves of the highest cut protection class • functional, highly elastic strip in the elbow area • integrated cuffs on sleeves without seams • protection and wearer comfort guaranteed even after repeated washing • cut protection made from Bamboo TwinFlex® material: extremely durable on the outside, pleasantly cool on the inside



uvex cut quatroflox trousers

Art. no. 17270 ● black, ● anthracite 42 to 64, 90 to 110
 (front of trouser legs)

material: trousers: 65% polyester, 35% cotton, front of trouser legs made from cut-protection material in accordance with EN 388: 2003, cut protection class 5, approx. 245 g/m²



Description: • sporty cut • functional, highly elastic strip in the knee area • integrated inserts to allow crosswise stretch along the side seam • waistband elasticated at the back • two back pockets • protection and wearer comfort guaranteed even after repeated washing • cut protection made from Bamboo TwinFlex® material: extremely durable on the outside, pleasantly cool on the inside



uvex

uvex cut



quatroflex
super elastic, lengthwise and
crosswise quatro structure
protects the elbow joint
and relieves strain

doubleflex
comfortable to wear,
retains its shape and allows a
long-sleeved top to be worn
underneath the shirt.

nanoflex
fits comfortably on the
upper and lower arm –
without restricting
freedom of movement

Bamboo TwinFlex® technology.
Extremely robust. Extremely comfortable.

Cut protection for hazardous working conditions

To meet the various and demanding hazards in metalworking or glass processing, our product range includes garments with heat-resistant shirt material.

With a weight per unit area of 195 g/m², the high modacrylic content of the heat-resistant shirt material offers limited protection against contact heat of up to 250°C, especially when handling hot metal. The cotton content ensures that the shirt remains comfortable to wear. Professional clothing with partial cut protection.

Outside extremely durable

Whether against blades, sheets of glass or sharp-edged workpieces: uvex cut protects while being comfortable to wear. This is guaranteed by the patented Bamboo TWIN-FLEX® technology with innovative double-face principle. Cut-resistant glass fibres and abrasion-resistant polyamide on the outside of the fabric ensure maximum protection (cut protection class 5) – delivering reliable protection even under extreme conditions.

Inside extremely comfortable

On the inside, soft bamboo yarn ensures a pleasantly cool feeling on the skin and optimal temperature regulation – so your employee is fully efficient, even under additional stresses such as high temperatures.

The durable Dyneema® fibre provides reliable protection against the material tearing. Even after repeated washing, uvex cut offers protection and wearer comfort of the highest level.



uvex



uvex cut doubleflex

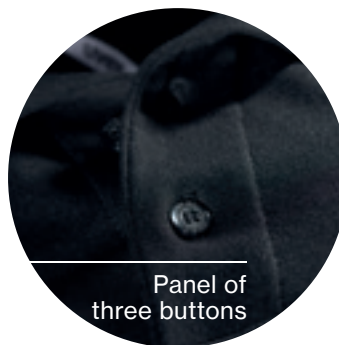

Panel of three buttons

uvex cut doubleflex polo shirt

Art. no. 17262 ● light grey, ● anthracite (sleeves + collar) S to 3XL
Art. no. 17263 ● black, ● anthracite (sleeves)
Art. no. 17264 ● black, ● anthracite (sleeves)

Material art. no. 17262 and 17263:
 polo shirt: 55% cotton, 45% polyester, ¾-length sleeves made from cut-protection material in accordance with EN 388: 2003, cut protection class 5, approx. 195 g/m²
Material art. no. 17264:
 54% modacrylic, 44% cotton, 2% antistatic fibres, approx. 195 g/m²



Description: • slim fit • made from breathable functional fibres with cut-protection sleeves of the highest cut protection class • panel with three buttons • integrated cuffs on sleeves without seams • protection and wearer comfort guaranteed even after repeated washing • cut protection made from Bamboo TwinFlex® material: extremely durable on the outside, pleasantly cool on the inside



uvex cut doubleflex T-shirt

Art. no. 17265 ● dark grey mix, ● anthracite (sleeves) S to 3XL

material: shirt: 50% cotton, 50% polyester, ¾-length sleeves made from cut-protection material in accordance with EN 388: 2003, cut protection class 5, approx. 160 g/m²



Description: • slim fit • made from single-jersey fabric with cut-protection sleeves of the highest cut protection class • integrated cuffs on sleeves without seams • protection and wearer comfort guaranteed even after repeated washing • cut protection made from Bamboo TwinFlex® material: extremely durable on the outside, pleasantly cool on the inside



uvex cut nanoflex



uvex cut nanoflex polo shirt

Art. no. 89881 ● light grey, ● anthracite (sleeves/collar) S to 3XL
Art. no. 89882 ● royal blue, ● anthracite (sleeves)
Art. no. 89883 ● orange, ● anthracite (sleeves)

material: polo shirt 55% cotton, 45% polyester, approx. 185 g/m² (art. no. 89881)
 100% cotton, approx. 230 g/m² (art. no. 89882)
 54% modacrylic, 44% cotton, 2% antistatic fibres, approx. 270 g/m²
 (art. no. 89883) ¾-length sleeves made from cut-protection material in
 accordance with EN 388: 2003, cut protection class 5



(for art. no. 89881 and 89882 only)

Description: • slim fit • made from breathable functional fibres with cut-protection sleeves of the highest cut protection class • panel with three buttons in a contrasting colour • lower arm with highly elastic inserts • reflective detailing on the shoulder (art. no. 89883) • protection and wearer comfort guaranteed even after repeated washing • cut protection made from Bamboo TwinFlex® material: extremely durable on the outside, pleasantly cool on the inside



uvex cut nanoflex T-shirt

Art. no. 17261 ● dark grey melange, ● anthracite (sleeves) S to 3XL

material: shirt: 50% cotton, 50% polyester, ¾-length sleeves made from cut-protection material in accordance with EN 388: 2003, cut protection class 5 approx. 160 g/m²



Description: • slim fit • made from single-jersey fabric with cut-protection sleeves of the highest cut protection class • lower arm with highly elastic inserts • protection and wearer comfort guaranteed even after repeated washing • cut protection made from Bamboo TwinFlex® material: extremely durable on the outside, pleasantly cool on the inside





cut level 5





For more information, visit uvex-safety.com

uvex protection flash

Conspicuous at night,
and a sporty eye-catcher by day

Even in rain, fog and darkness, you can still work outside. It's essential that everyone can be seen – despite the poor visibility. The high-visibility clothing from the uvex protection flash collection uses bright reflective strips. And some models even light up independently. This is thanks to the innovative light guide system, which we have developed together with OSRAM®.

And of course the cargo trousers and softshell jackets with their sporty fit can also be seen in daylight – after all, they were designed by uvex...



Video:

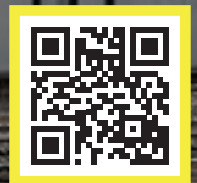

For more information, visit
uvex-safety.com



uvex

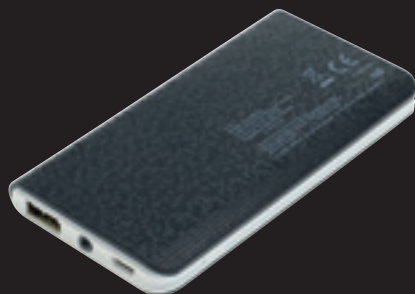

Battery pack

Art. no. 8997100

Description: • portable external battery for art. no. 17255, 89910, 89909, 89718
• dimensions: 113 x 58 x 12 mm, approx. 100 g



Battery pack for models with switch

Art. no. 1733200 ● white

Description: • portable external battery for art. no. 17322, 17323, 17324 • dimensions: 93 x 58 x 12 mm, approx. 83 g



EN ISO 20471



Vest Vest with switch

Art. no. 17255 ● high-vis yellow, ● high-vis orange M to 3XL
Art. no. 17322 ● high-vis yellow, ● high-vis orange
(with switch)

material: 65% polyester, 35% cotton, approx. 245 g/m²



Description: • active protection thanks to horizontal and vertical light guide system • velcro fastening to quickly fasten the vest • version with switch for different lighting modes available (for art. no. 17322 only)

uvex protection flash



EN ISO 20471



Softshell jacket

Art. no. 89910 ● high-vis yellow ● grey S to 6XL

material: 100% polyester, with three-layer membrane, approx. 240 g/m²



Description: • windproof and waterproof high-visibility softshell jacket • a Napoleon pocket on the left and two large side pockets with zip • active protection thanks to the integrated light guide system • 10,000 mm water column rating • lightweight, robust and breathable material

EN ISO 20471



Vest
Vest with switch

Art. no. 89909 ● high-vis yellow
Art. no. 89718* ● high-vis orange
Art. no. 17323 (with switch) ● high-vis yellow
Art. no. 17324 (with switch) ● high-vis orange

material: 100% polyester, mesh



Description: • active protection thanks to vertical light guide system • velcro fastening to quickly fasten the vest • version with switch for different light modes (for art. no. 17323 and 17324 only)

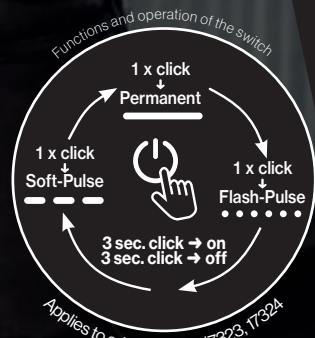

Benefit from our knowledge

The uvex academy provides qualified education and training in the fields of personal protective equipment (PPE) and health and safety at work.

All uvex academy training sessions are offered in-house or as company seminars. Seminars in accordance with your individual specifications can be developed on request.

- Laser protection
- Protective eyewear (more information on page 45)
- Prescription safety spectacles/goggles (more information on page 424)
- Hearing protection
- Hand protection (more information on page 197)
- Protective footwear (more information on page 356)
- Internships



The uvex academy is
your competent partner
for qualified training and further education.

You can find more information
at uvex-academy.com



EUROPA

UVEX ARBEITSSCHUTZ GMBH

Würzburger Straße 181-189
90766 Fürth
GERMANY

Tel.: 0800 6644893
Fax: 0800 6644894

E-Mail: serviceteam@uvex.de
Internet: uvex-safety.de

UVEX SAFETY Textiles GmbH

Robert-Schumann-Straße 33
08236 Ellefeld
GERMANY

Tel.: +49 3745 740-0
Fax: +49 3745 740-100

E-Mail: corporatefashion@uvex.de
Internet: uvex-safety.de

UVEX SAFETY Gloves GmbH & Co. KG

Elso-Klöver-Straße 6
21337 Lüneburg
Postfach 24 47 · 21314 Lüneburg
GERMANY

Tel.: +49 4131 9502-0
Fax: +49 4131 84338

E-Mail: gloves@uvex.de
Internet: uvex-safety.de

UVEX SAFETY Austria GmbH

Kamerlweg 33
4600 Wels
AUSTRIA

Tel.: +43 7242 210 745
Fax: +43 7242 210 745-28

E-Mail: safety@uvex.at
Internet: uvex-safety.at

UVEX Arbeitsschutz (Schweiz) AG

Uferstrasse 90
CH-4057 Basel
SWITZERLAND

Tel.: +41 61 638 84 44
Fax: +41 61 638 84 54

E-Mail: info@uvex.ch
Internet: uvex-safety.ch

UVEX HECKEL s.a.s.

44 rue d'Engwiller
La Walck
67350 Val de Moder
FRANCE

Tel.: +33 3 88 07 61 08
Fax: +33 3 88 72 51 06

E-Mail: contact.france@uvex-heckel.fr
contact.export@uvex-heckel.fr
Internet: uvex-heckel.fr

UVEX SAFETY (UK) LTD

uvex House
Farnham Trading Estate
Farnham
Surrey
GU9 9NW
UNITED KINGDOM

Tel.: +44 1252 73 12 00
Fax: +44 1252 73 39 68

E-Mail: safety@uvex.co.uk
Internet: uvex-safety.co.uk

UVEX Safety Italia S.R.L.

Corso Grosseto 437
10151 Torino
ITALY

Tel.: +39 011 4536511
Fax: +39 011 7399522

E-Mail: info@uvex-safety.it
Internet: uvex-safety.it

UVEX Safety Scandinavia AB

Pumpvägen 4
24393 Höör
SWEDEN

Tel.: +45 75661612
Mobile: +45 21466656

E-Mail: nordic@uvex.de
Internet: uvex-safety.se

UVEX SPR OOO

Blagodatnaya str. 67
196105 St. Petersburg
RUSSIA

Tel.: +7 812 327 6781 and
8 800 500 78 90

Fax: +7 812 327 6781

E-Mail: uvex@uvex-safety.ru
Internet: uvex-safety.ru

UVEX SAFETY Polska sp. z o.o.sp.k.

Większyce, ul. Głogowska 3A
47-208 Reńska Wieś
POLAND

Tel.: +48 77 482 62 58
Fax: +48 77 482 62 57

E-Mail: uvex@uvex-integra.pl
Internet: uvex-safety.pl

UVEX Safety CZ, k.s.

Na Jamách 394
516 01 Rychnov nad Kněžnou
CZECH REPUBLIC

Tel.: +420 494 531 331
Fax: +420 494 533 395

E-Mail: info@uvex.cz
Internet: uvex-safety.cz

UVEX Safety SK k.s.

Jesenná 1
080 05 Prešov
SLOVAKIA

Tel.: +421 517 732 138
Fax: +421 517 594 771

E-Mail: uvex@uvex-safety.sk
Internet: uvex-safety.sk

UVEX Safety Hungaria Bt.

Terstyánszky u. 23.
2083 Solymár
HUNGARY

Tel.: +36 26 560093
Mobile: +36 30 4773135
Fax: +36 26 560092

E-Mail: e.boros@uvex.de
Internet: uvex-safety.hu

ASIA · PACIFIC · AUSTRALIA

UVEX (GUANGZHOU) SAFETY CO. LTD

No. 3, Building ShenLan Industrial Zone
ShiBei Avenue Dashi Panyu
Guangzhou Guangdong
CHINA 511430

Tel.: +86 20 3479 2338
Fax: +86 20 3479 1098

E-Mail: info@uvex.com.cn
Internet: uvex.com.cn

UVEX SAFETY SINGAPORE PTE. LTD.

25, International Business Park
#03-112/113, German Centre
Singapore 609916
SINGAPORE

Tel.: +65 6562 8138
Fax: +65 6562 8139

E-Mail: sales@uvex-safety.com.sg
Internet: uvex-safety.com.sg

UVEX SAFETY AUSTRALIA LIMITED PARTNERSHIP

Unit 3 Riverside Centre
24-28 River Road West
Parramatta NSW 2150
AUSTRALIA

Tel.: +61 2 9891 1700
Fax: +61 2 9891 1788

E-Mail: info@uvex.com.au
Internet: uvex-safety.com.au

Sydney 1800 815 790
Melbourne +61 3 9832 0851
Brisbane +61 7 3394 8414
Adelaide +61 8 8376 0732
Perth +61 8 9209 1444

UVEX Safety New Zealand Pty Ltd

Tel.: +64 9476 1015 and
+64 800 698 839

E-Mail: info@uvex.co.nz
Internet: uvex-safety.co.nz

AFRICA · MIDDLE EAST AND INDIA

uvex safety South Africa (Pty) Ltd

2 Kubu Avenue,
Riverhorse Valley,
Effingham, Durban, 4051
SOUTH AFRICA

Tel.: +27 31 569 67 80
Fax: +27 31 569 67 81

E-Mail: info@uvex.co.za
Internet: uvex.co.za

For Indonesia:

UVEX SAFETY SINGAPORE PTE. LTD.

Representative Office Indonesia
Pondok Indah Office Tower 3, 17th Floor
Jl. Sultan Iskandar Muda, Kav. V-TA
Pondok Indah, Jakarta 12310
INDONESIA

Tel.: +6221 2953 8910
E-Mail: sales@uvex-safety.com.sg
Internet: uvex-safety.co.id/id

For Malaysia:

UVEX SAFETY SINGAPORE PTE. LTD.

Regional Office Malaysia
1 Sentral, Level 16,
Jalan Stesen Sentral 5,
KL Sentral, Kuala Lumpur 50470
MALAYSIA

Tel.: +603 2092 9261
Fax: +603 2092 9201
E-Mail: sales@uvex-safety.com.sg
Internet: uvex-safety.com.my

UVEX ARBEITSSCHUTZ GMBH

Dubai Office
B6-606
HQ Building
Dubai Silicon Oasis
Dubai
UAE

Middle East & India:
Tel.: +971 4 372 4753
E-Mail: sales@uvex.co.za
Internet: uvex-safety.com

| | | | |
|----------------------------|----|---------------------------|-----------|
| uvex Safety Eyewear | | | 11 |
| Coating technology | 14 | Welding protection | 58 |
| Labelling and norms | 17 | Accessories | 66 |
| Lens tinting | 18 | Cord/case mix | 72 |
| Safety spectacles | 22 | Applications | 73 |
| Overspecs | 46 | Safety eyewear – Overview | 74 |
| Safety goggles | 48 | | |

| | | | |
|-------------------------------------|----|-------------------------------|-----------|
| uvex Hearing Protection | | | 77 |
| All ears when it comes to safety | 78 | Banded ear protection | 92 |
| Size and fit | 80 | uvex earmuff range | 94 |
| Disposable hearing protection plugs | 84 | uvex pheos helmet system | 98 |
| Reusable ear plugs | 88 | Accessories | 100 |
| Detectable | 90 | Hearing protection – Overview | 102 |

| | | | |
|---------------------------------------|-----|-----------------------------------|------------|
| uvex Safety Helmets | | | 103 |
| Standards at a glance | 104 | Visors and face protection | 126 |
| Safety helmets | 106 | Face protection system | 130 |
| Accessories | 116 | Accessories – combination options | 133 |
| Head torchs | 119 | Impact caps | 136 |
| Visor lenses, certification and norms | 122 | Safety helmets – Overview | 139 |

| | | | |
|--|-----|---------------------------------|------------|
| uvex Breathing Protection | | | 141 |
| Respirator advisor | 143 | Respirators uvex silv-Air e | 154 |
| The uvex breathing protection navigator | 144 | Respirators uvex silv-Air p | 157 |
| Applications | 145 | Respirators uvex silv-Air c | 162 |
| Combination options with uvex safety eyewear | 146 | Pictograms – Functions | 166 |
| Respirators uvex silv-Air premium | 148 | Breathing protection – Overview | 167 |

| | | | |
|-----------------------------------|-----|--|------------|
| uvex Disposable Coveralls | | | 169 |
| Guide to standards and products | 170 | Individual climate comfort | 183 |
| Disposable coverall type 3B | 173 | Protection against infectious diseases | 184 |
| Disposable coverall type 4B | 177 | Permeation | 185 |
| Disposable coveralls type Typ 5/6 | 178 | Guidelines for use | 186 |
| Accessories | 181 | uvex Chemical Expert System | 190 |
| Material and seam technology | 182 | | |

| | | | |
|---|-----|--------------------------|------------|
| uvex Safety Gloves | | | 191 |
| uvex Chemical Expert System | 196 | uvex Glove Navigator | 204 |
| Modification to standards for safety gloves | | Mechanical risks | 205 |
| EN 388, EN ISO 374, DIN EN 36350 | 198 | Chemical risks | 244 |
| Suitability grades for safety gloves | | Disposable safety gloves | 255 |
| in the food industry | 201 | Safety gloves – Overview | 256 |

| | | | |
|-----------------------------|-----|----------------------------|------------|
| uvex Safety Footwear | | | 257 |
| uvex climazone | 258 | Safety footwear | 268 |
| Areas of application | 262 | Accessories: inlay soles | 344 |
| Pictogram overview | 263 | uvex care system | 348 |
| Standards and labels | 264 | Polymer boots | 349 |
| ESD | 266 | Safety footwear – Overview | 350 |
| uvex multiple width system | 267 | | |

| | | | |
|-----------------------------|-----|---|------------|
| uvex Individual PPE | | | 357 |
| Prescription safety eyewear | 364 | IndividueTailor-made hearing protection uvex high-fit | 400 |
| VDU spectacles | 392 | Orthopedic foot protection uvex medicare | 414 |

| | | | |
|----------------------------------|-----|----------------------------------|------------|
| uvex Workwear | | | 425 |
| Sustainability | 426 | uvex new worker collection | 437 |
| uvex collection 26 | 428 | uvex perfect collection | 438 |
| uvex suXXeed collection | 434 | uvex multi function collection | 439 |
| uvex perfeXXion collection | 435 | uvex cut collection | 440 |
| uvex handwerk profisystem metall | 436 | uvex protection flash collection | 450 |

uvex



English Version

UVEX ARBEITSSCHUTZ GMBH
Würzburger Straße 181-189
90766 Fürth
GERMANY

Phone: +49 911 9736-0
Fax: +49 911 9736-1760
E-Mail: safety@uvex.de
Internet: uvex-safety.com

protecting people

